



HDMI[®]
HIGH-DEFINITION MULTIMEDIA INTERFACE

UPUTSTVO ZA UPOTREBU

LED TELEVIZORI Model:32DLE80

Hvala Vam što ste kupili ovaj uređaj.

FOX LED televizori prepoznaju se po odličnim tehničkim karakteristikama, kao i modernom, funkcionalnom i elegantnom dizajnu. Osim toga konstantna unapređenja u vidu postprodajne podrške, izuzetno efikasna i rasprostranjena servisna mreža čine da se ponosni vlasnici FOX televizora mogu osećati sigurno.

Napravili ste pravi izbor.

U nastavku slede uputstva za upotrebu. Nisu komplikovana, ali ih se morate pridržavati.

EN

SR

Table Of Contents

Preparations Guide

Safety Information.....	2
Important Safety Precautions.....	3

Installed And Connected TV

TV Bracket assemble.....	4
TV Buttons And Terminal Interface.....	5
External device connection diagram.....	6
Install And Connect TV.....	7
TV Stand installation Instructions.....	7

TV Menu

Input Source.....	8
Channel Menu.....	8
Picture Menu.....	9
Sound Menu.....	10
Time Menu.....	10
Option Menu.....	10

PC Menu

Screen Menu.....	12
------------------	----

Media Menu

Media Menu.....	12
-----------------	----

Other Information

Help.....	13
Specifications.....	14
Remote Controller.....	15

This user manual for reference only

Safety Information

CAUTION

**RISK OF ELECTRIC SHOCK
DO NOT OPEN**

High voltages are used in the operation of this product. to reduce the risk of electric shock, do not remove cover of the cabinet, refer servicing to qualified service personal

If the TV any changes or coarse adjustment, electric shocks to be hurt, do not attempt to open a machine-maintenance, customer contact centres needed overhaul.



The exclamation point within an equilateral triangle is intended to alert the user to the presence of important operating in the literature accompanying the appliance.

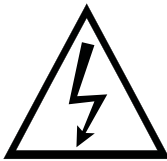

Warning
The lightning flash with arrowhead symbol within an equilateral triangle, is intended to alert the user to the presence of uninsulated dangerous voltage within the products enclosure that may be of sufficient magnitude to constitute a risk of electric shock to persons.

Important Safety Precautions

- 1) Read these instructions.
- 2) Keep these instructions.
- 3) Heed all warnings.
- 4) Follow all instructions.
- 5) Do not use this apparatus near water.
- 6) Clean only with dry cloth.
- 7) Do not block any ventilation openings. Install in accordance with the manufacturer's instructions.
- 8) Do not install near any heat sources such as radiators, heat registers, stoves, or other apparatus (including amplifiers) that produce heat.
- 9) Do not defeat the safety purpose of the polarized or grounding-type plug. A polarized plug has two blades with one wider than the other. A grounding type plug has two blades and a third grounding prong. The wide blade or the third prong are provided for your safety, If the provided plug does not fit into your outlet, consult an electrician for replacement of the obsolete outlet.
- 10) Protect the power cord from being walked on or pinched particularly at Plugs, convenience receptacles, and the point where they exit from the apparatus.
- 11) Only use attachments /accessories specified by the manufacturer.
- 12) Use only with the cart, stand, tripod, bracket, or table specified by the manufacturer, or sold with the apparatus. When a cart is used caution when moving the cart/apparatus combination to avoid injury tip-over.



- 13) Unplug this apparatus during lightning storms or when unused for long periods of time.

Caution:

- 14) To reduce the risk of fire or electric shock, do not expose this apparatus to rain or moisture.
- 15) The mains plug is used as disconnect device, the disconnect device shall remain readily operable.
- 16) The socket-out shall be installed near the equipment and shall be easily accessible.
- 17) This product should never be placed in a built-in installation such as a bookcase or rack unless proper ventilation is provided or the manufacture's instructions have been adhered to.
- 18) The apparatus shall not be exposed to dripping or splashing and that no objects filled with liquid, such as vases, shall be placed on the apparatus.
- 19) Do not place any sources of danger on the apparatus (e.g. liquid filled objects, lighted candles).
- 20) Wall or Ceiling Mounting - The appliance should be mounted to a wall or ceiling only as recommended by the manufacturer.
- 21)  Never place the TV, remote control or batteries near naked flames or other heat sources, including direct sunlight. To prevent the spread of fire, keep candles or other flames away from the TV, remote control and batteries at all times.
- 22) The USB terminal should be loaded with 0.5 A under normal operation.

These servicing instructions are for use by qualified service personnel only. To reduce the risk of electric shock do not perform any servicing other than that contained in the operating instructions.

unless you are qualified to do so.

- 23) The battery shall not be exposed to excessive heat such as sunshine, fire or the like.
- 24)  This equipment is a Class II or double insulated electrical appliance. It has been designed in such a way that it does not require a safety connection to electrical earth
- 25) The maximum using environment temperature is 45 degrees.
The Maximum using altitude is 2000 meters

TV Bracket assemble

Fix the TV on the wall

1. First, put the TV on the table smoothly and put some soft cloth on the table to avoid scratching the screen.
2. Use the screw driver to take off the screws which are fixed on the bottom stand (the direction of the arrow, refer to the photo 1). And take off the bottom stand (please take off the screws and bottom stand carefully).
3. Make one bracket which can fix on the wall according to the size of arrow direction of photo 2 and photo 3.
4. Drill four holes properly on the wall (the size only for reference) and put into four screws. (optional parts) Drill four holes properly on the wall (the size only for reference) and put into four screws. (optional parts)
5. according to the step 4, use the screwdriver to lock the screw on the back of the TV, then hang the TV on the wall.

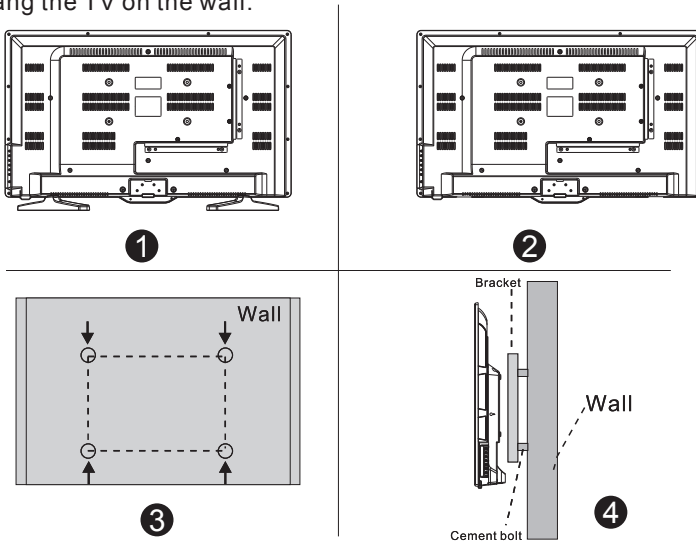

Note:

1. The bracket fixed on the wall is optional part.
2. when you assemble the TV, there should be no other articles on the around and front and please keep the distance from other articles.
3. When assemble the TV, please ask the career man to fix in order to avoid the danger.
4. The fixing picture is only for reference.
5. Please follow the use manual about bracket assemble to fix the TV.
6. Attach the mounting bracket from the VESA compatible wall mounting kit.

NOTE:

IF YOUR PROGRAM ON TV WILL BE INCLUDED BY CABLE TELEVISIONS, PLEASE CHECK YOUR EARNING AND POTENTIAL EVALUATION ON THE CABLE OF YOUR CABLE OPERATOR.
FOR THESE INFORMATION CONTACT YOUR CABLE OPERATOR.

TV Buttons And Terminal Interface

TV Buttons

Note: The key instructions are subject to below.









Display \ Hide key icon: When there is no button icon popping up, press the key, the key icon will pop up like the picture shows above, the key icon will automatically turn off after 5 seconds of inactivity.

Icon selection: Short press the button, move the loop to the right, select the icon.











Icon function selection: Long press the key to achieve the function of the selected icon.

Icon Description:n

-  : **Power off Icon:** Corresponding to the "POWER" button of remote .
-  : **Menu Icon:** Corresponding to the "MENU" button of remote.
-  : **Source Icon:** Corresponding to the "SOURCE" button of remote.
-  : **CH+ Icon:** Corresponding to the "CH+" button of remote.
-  : **CH- Icon:** Corresponding to the "CH-" button of remote.
-  : **Volume+ Icon:** Corresponding to the "VOL+" button of remote.
-  : **Volume- Icon:** Corresponding to the "VOL-" button of remote.

Terminal Interface

Note: The following are the various terminal interface, the actual position and arrangement, the number of different models may be different.

	AV input External AV Signal Input		EARPHONE output When earphones are plugged in, speakers are disabled
	Y Pb Pr input Connect to the composite terminal of your DVD/VCR		USB input Connect a USB device here to play its media files or to record programs via the PVR function.
	HDMI input Digital signal input from HDMI video connector.		COAXIAL Connect the SPDIF receiver.
	ANT 75 Connect the antenna/cable tv input (75/VHF/UHF)		CI SLOT The card reader input CI (common interface) this requires CAM (conditional access module) used for pay TV.
	VGA input PC analog signal input		SCART input standard, it supports composite and RGB signal input, it is a connection for european (Some models without this interface)
	PC AUDIO INPUT VGA input and audio input when VGA input		

External device connection diagram

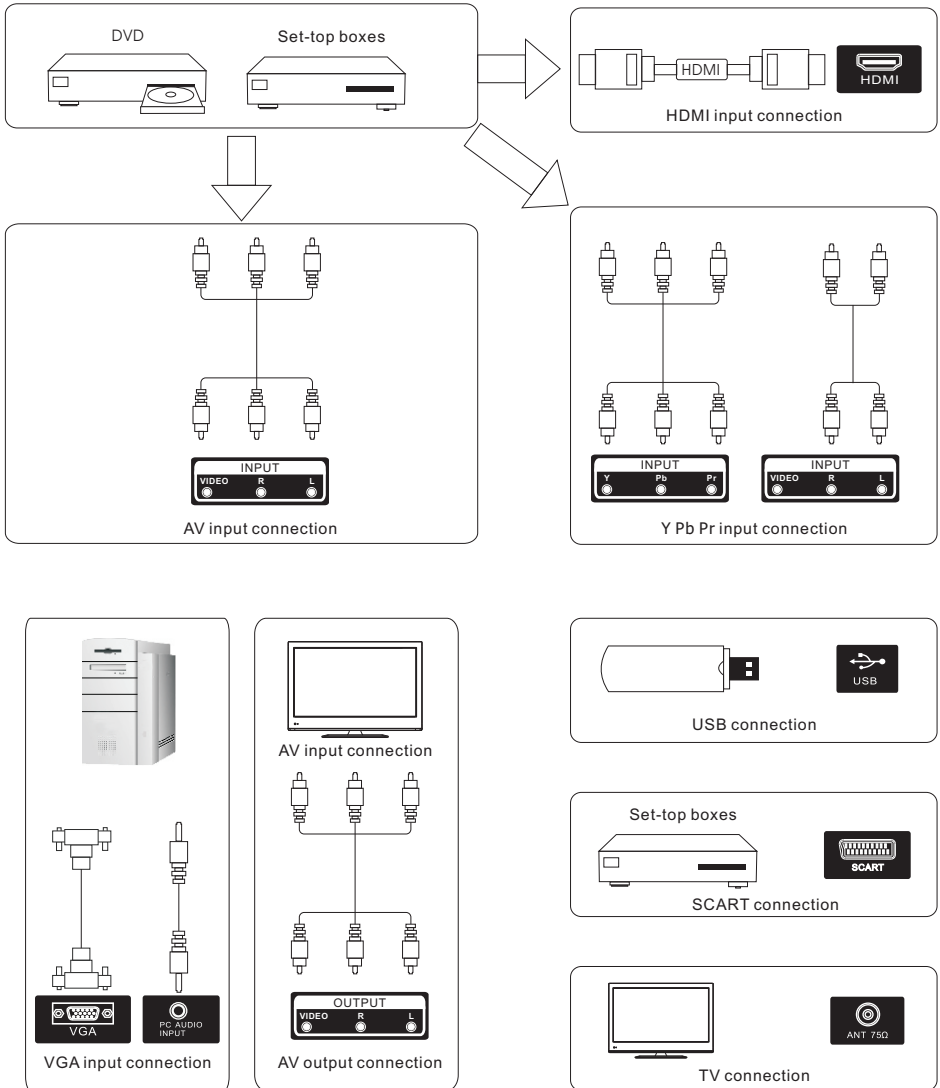

Install And Connect TV

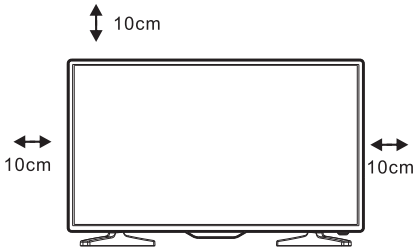

Set your TV

To put your TV in a firm place which can bear the weight of the TV.
To avoid danger, please don't expose the TV near water or heating place (such as light, candle, heating machine), do not block the ventilation at the back of TV.

3

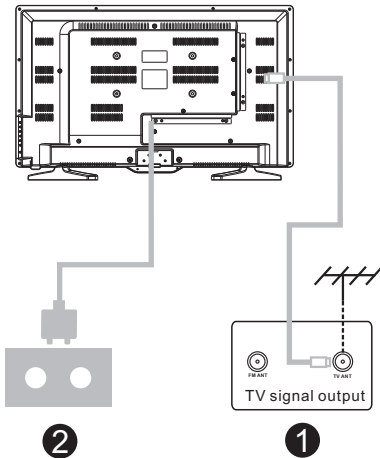

Connect antenna and power

1. Connect the antenna cable to the antenna socket on the back of the TV.
2. To plug the power cord of TV (AC 100-240V~ 50/60Hz).

Turn on TV

3. Press the power button of the TV the indication light will turn to green. if it is on standby mode (the light is red), press the power button on the remote control to turn on the TV.

Note:

Picture for reference purposes only.

TV Stand Installation Instructions

1. Open the carton and remove the TV and scattered accessories and base (some models without base).
2. To avoid the injury of the TV, covered with a soft mattress, put it on the table, face down on a soft mattress, the base of the neck is fixed on the TV with screws.
3. Screw the base and connected to the TV.
4. The installation is complete.

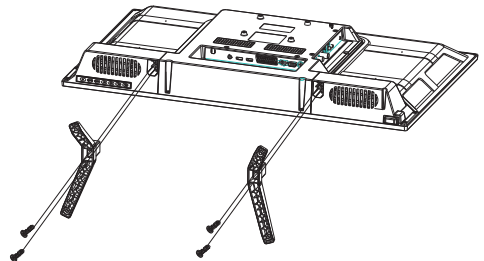

Note:

Picture for reference purposes only.

TV Menu

Input Source

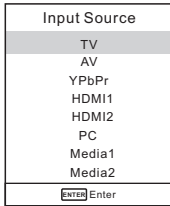

Note: The above is for reference only, to prevail any kind
Press SOURCE to display the input source list.
Press ▼/▲ to highlight the input source and press ENTER to confirm.
Press EXIT to hide the On-Screen menu.

Channel Menu

NTSC Channel Menu

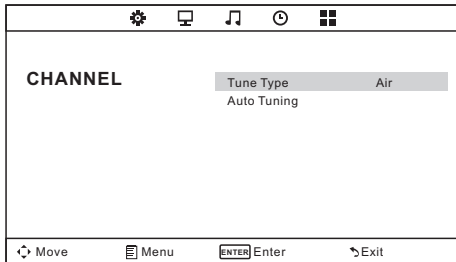

PAL Channel Menu

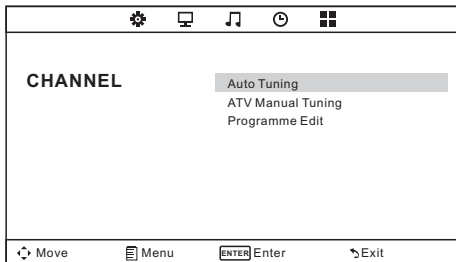

Note: The Channel Menu is available only in TV mode, and the item is the default when pressing MENU, if you want view the Picture/Sound/Time/Option Menu, please press ◀/▶ to select.

Tune Type Cable/Air

Auto Tuning

Auto Tuning will search for available channels and programs. Press ▼/▲ to select Auto Tuning, then press Enter to start auto search. If you want to stop searching, press MENU or EXIT.

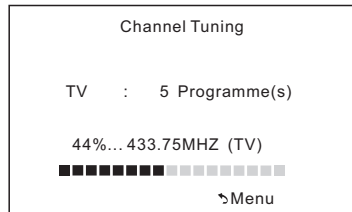

ATV Manual Tuning

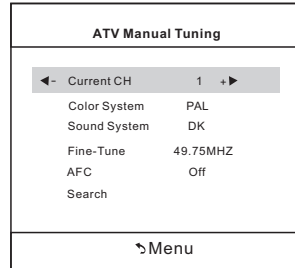

Current CH

Set the channel number

Color system

Select the color system(PAL/SECAM)

Sound System

Select the sound system(DK/BG/I)

Fine-Turn

Adjust the frequency of the channel finely.

AFC

Automatic Fine tuning.

Search

Please press ◀/▶ to select .

TV Menu

Programm Edit

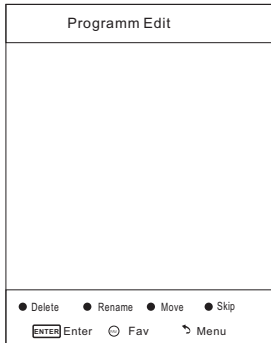

The four colored key is the shortcut key for programming the channel.

First press ▼/▲ to highlight the channel you want to delete or rename or move or skip, then:

Press the **Red** button to delete the channel.

Press the **Green** button to enter the rename state, then press ◀/▶ to select the word you want to change, and ▼/▲ to select word.

Press the **Yellow** button to set the channel to moving state. then press ▼/▲ to move it to the position you want to put.

Press the **Blue** button to skip the select channel.

Fav Add or Delete the channel to your favorite list.

Picture Menu

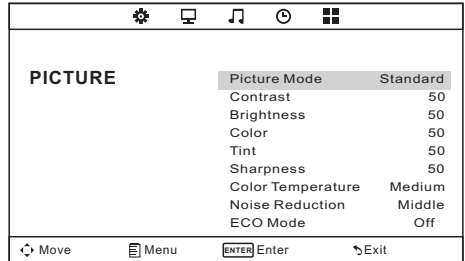

Picture Mode

Highlight the item and Press ENTER or ◀/▶ to enter the sub-menu, that shows the picture mode you can choose:

Dynamic/Standard/Mild/User

Press PMODE on the remote control

to select picture mode directly.

Contrast

Adjust the white level of the picture.

Brightness

Adjust darkness of black sections in the picture.

Color

Adjust the color intensity of the picture.

Tint

Adjust the hue (Red, Green, Blue) of the picture.

Sharpness

Object edges are enhanced for picture detail.

Color Temperature

Select the color temperature that you feel comfortable.

Noise Reduction

Off/Low/Middle/High

You can clear up the input signal by setting the item.

ECO Mode

It is used to ON/OFF the ECO mode.

TV Menu

Sound Menu

SOUND	
Sound Mode	Standard
Treble	50
Bass	50
Balance	0
Auto Volume	Off
SPDIF MODE	PCM

◀ Move Menu [ENTER] Enter ▶ Exit

Sound Mode

Standard/Music/Movie/Sports/User/Only in this mode. Treble and Bass can be adjusted.)

Treble

Adjust the high frequency sounds.

Bass

Adjust the low frequency sounds.

Balance

Adjust the level of sound coming from the left and right speakers.

Auto Volume

Press ◀/▶ select ON or OFF . Auto Volume.

SPDIF MODE

Press [ENTER]/RIGHT button to enter, then press UP/DOWN button to select Off / Auto / PCM.

Time Menu

TIME	
Sleep Timer	Off
Auto Sleep	Off
OSD Timer	10s

◀ Move Menu [ENTER] Enter ▶ Exit

Sleep Timer

Select the time in minutes(off, 10min, 20min, 30min, 60min, 90min, 120min, 180min, 240min) that you want the TV to shut off automatically after you set the time. Cancel by setting it to Off

Auto Sleep

Select the time in hours(off, 3h, 4h, 5h) that you want the TV to remain on after your last operation. Cancel by setting it to Off.

OSD Timer

Select the time in seconds(5s, 10s, 15s, 20s, 25s, 30s,) that you want the On-Screen Men remain display after your last operation.

Option Menu

OPTION	
OSD Language	English
Aspect Ratio	16:9
Blue Screen	Off
Key Lock	Off
Caption	Off
Parent Control	
Reset	
Software Update(USB)	

◀ Move Menu [ENTER] Enter ▶ Exit

TV Menu

OSD Language

Set the OSD display language.

Aspect Ratio

Select the suitable aspect Ratio.

Blue Screen

Set the background color to blue or black when having no input signal.

Key Lock

Set to prevent it from being used by young children, or other unexpected using.

Caption(NTSC)

Select from below closed-caption modes.

CC1,2,3,4 Displays corresponding caption channels of a analog program. (Usually be set to Cc1 for most programs.)

Text1,2,3,4 Displays corresponding text service channel of a analog program.

Parent Control(NTSC)

Set Password	
Lock System	ON
TV	
MPAA	R
Canada English	PG
Canada French	G
↵Menu	

Set Password First you should enter the correct old password then enter new password twice.

Lock System

Set the lock system ON or OFF.

TV

TV rating			
TV-Y	ALL		
TV-Y7	ALL	FV	
TV-G	ALL		
TV-PG	ALL	V	S L D
TV-14	ALL	V	S L D
TV-MA	ALL	V	S L
↵Menu			

- TV-Y** General audience
- TV-Y7** Parental guidance suggested
- TV-G** Parents strongly cautioned
- TV-PG** Restricted
- TV-14** No one 17 and under admitted
- TV-MA** Adult audience only.
- FV** Fantasy violence
- D** Suggestive dialogue
- L** Strong language
- S** Sexual situations
- V** Violence
- MPAA** This system defines the rating control which come from MPAA rules.
- G** General audience. All ages admitted
- PG** Parental guidance
- PG-13** Parents strongly cautioned. Some material may be inappropriate for children under 13.
- R** Restricted. Children under 17 require accompanying parent or adult guardian.
- NC-17** No one 17 and under a admitted.
- X** Adult audience only
- N/A** Not available
- Canada English** The ratings are for programs which are using English rating system.
- C** Children
- C8+** Children 8 years and older
- G** General programming
- PG** Parental guidance
- 14+** Viewers 14 and older
- 18+** Adult programming
- E** Exempt
- Canada French** The ratings are for programs which are using French rating system.
- G** General
- 8 ans+** Not recommended for younger children

TV Menu

13 ans+ Not recommended for children under age 13

16 ans+ Not recommended for ages under 16

18 ans+ This program is restricted to adults

E Exempt

Reset Recall the default setting.

Software Update(USB) Update your TV set. Select the software in the root of your USB memory, and press ENTER.

PC Menu

Screen Menu

SCREEN	
Auto Adjust	
Horizontal Pos.	50
Vertical Pos.	50
Clock	50
Phase	99

◀ Move Menu ENTER Enter ▶ Exit

Auto Adjust

Automatically adjust Clock, Phase, H-Position, and V-Position settings.

Horizontal Pos.

Shift the screen up or down.

Vertical Pos.

Shift the screen left or right.

Clock

Adjust the internal sampling clock rate.

Phase

Adjust the internal signal phase.

Media Menu

Media Menu

The color of the icon means whether your TV has detected a USB memory or not. Blue: Yes; Gray: No;



Press ◀/▶ to select **Photo/Music/Movie/Text** icon and ENTER to enter the USB memory.

Help

No Power	Check the AC cord of TV is plus in or not. If still no power, please Pull out the plug and replug in after 60 seconds. And open the TV again
Signal receive not properly	<ul style="list-style-type: none"> ● To cause double image or phantom if there has high building or high mountain round TV. You can adjust image effect by manually operation: consult instruction of vernier regulation or change the direction of external antenna. ● If you use the indoor antenna . under certain circumstance, receive will be more difficult . So you can change the direction of the antenna to adjust the image effect . If can't change image receiving effect either , you have to use external antenna.
No picture	<ul style="list-style-type: none"> ● Check the antenna at the back of TV is connected properly or not. ● Try to select other channels and check whether the TV problem itself or not
but, Video is ok without audio	<ul style="list-style-type: none"> ● Increase the volume. ● Check the TV is in mute mode or not , and please press the mute button to make sound resume.
Audio is ok, but color error or no picture.	<ul style="list-style-type: none"> ● Increase contrast and brightness.
snow statics picture and noise	. Check the antenna at the back of TV is connected or not
Level broken line	vacuum, such as hair drier, Maybe has electrical appliance interfere- please turn off these kinds of electrical appliance, cleaner and so on.
Image or-Dual "simulacrum" The TV no response with the Remote.	<ul style="list-style-type: none"> ● Perhaps the location for the antenna is not good. Use the tall beamed antenna can be improved quality of the display image. ● Operate the remote direct to the remote sensor on the TV. If still no response for the TV, please check if the plastic bag on the remote take or not. And check if the location for the battery is correct. Change the new battery. ● The TV will shift to the STAND BY if no response from the remote in the few minutes.
.NO Video In (PC Mode)	<ul style="list-style-type: none"> ● Please check if the display cable connect to the VGA correcte . ● Please check if there has the bend on the display cable.
Vertical twinkling (PC Mode)	<ul style="list-style-type: none"> ● Enter the main menu, Use the clock regulator for the Video display noise to eliminate the vertical line.
horizontal ripping (PC Mode)	<ul style="list-style-type: none"> ● Adjust the Audio sound horizontal in the main menu to clear the horizontal ripping line.
The screen is too bright or too dark (PC Mode)	<ul style="list-style-type: none"> ● Adjust the contrast ratio or brightness in the main menu.
PC Function no response	<ul style="list-style-type: none"> ● Check the computer setting in the state of compatible display resolution
Ripping line in RCA connecting	<ul style="list-style-type: none"> ● Please use good quality connecting cable.
Problem still exist	<ul style="list-style-type: none"> ● Unplug the power cable and wait for 30 seconds, then connect. If there is some problem with our TV, do not repair it by yourself, please contact with the customer service center.

There will be complete picture and the brightness will come down if the TV is in: Note So please do not keep the TV in a state of same, the static picture for too long time Menu or same picture that has much difference in brightness and contrast ratio for too long time.

Machine Technical Specifications

Screen Size	TV System	Preset Channels	Speaker Output
16"	PAL/NTSC	PAL:0-199,NTSC:AIR 2-69 CABLE1-125	5W+5W
19"	PAL/NTSC	PAL:0-199,NTSC:AIR 2-69 CABLE1-125	5W+5W
20"	PAL/NTSC	PAL:0-199,NTSC:AIR 2-69 CABLE1-125	5W+5W
22"	PAL/NTSC	PAL:0-199,NTSC:AIR 2-69 CABLE1-125	5W+5W
24"	PAL/NTSC	PAL:0-199,NTSC:AIR 2-69 CABLE1-125	5W+5W
28"	PAL/NTSC	PAL:0-199,NTSC:AIR 2-69 CABLE1-125	8W+ 8W
32"	PAL/NTSC	PAL:0-199,NTSC:AIR 2-69 CABLE1-125	10W+10W
39"/40"	PAL/NTSC	PAL:0-199 NTSC:AIR 2-69 CABLE1-125	10W+10W
42"	PAL/NTSC	PAL:0-199,NTSC:AIR 2-69 CABLE1-125	10W+10W
43"	PAL/NTSC	PAL:0-199,NTSC:AIR 2-69 CABLE1-125	10W+10W
46"	PAL/NTSC	PAL:0-199,NTSC:AIR 2-69 CABLE1-125	10W+10W
50"	PAL/NTSC	PAL:0-199,NTSC:AIR 2-69 CABLE1-125	10W+10W
65"	PAL/NTSC	PAL:0-199,NTSC:AIR 2-69 CABLE1-125	10W+10W

Screen Size	power Consumption	Main accessories
16"	24W	User's manual x1 Remote controller x1 Power cord x1 AAA Batteries x2
19"	36W/48W	
20"	36W/48W	
22"	36W/48W	
24"	36W/48W	
28"	36W	
32"	56W/65W/100W	
39"/40"	60W/70W/76W	
42"	67W/70W/95W/100W	
43"	65W/80W	
50"	100W/108W/135W	
55"	100W/135W/140W/160W	
65"	159W/165W/195W	

Remote Controller

Descriptions of television remote control

- 1.POWER:** Turn on the TV or enter standby mode.
- 2.MUTE:** Turn off the sound and turn on when press again.
- 3.0-9:** Figures "0-9" are used to directly input channel number.
- 4. - / - -** Press this button to enter a program number for different digit, eg. - / - - / ---
- 5. ↻** Press this button to toggle between the current and the previous programme you were you were viewing
- 6.S.MODE:** Select the different sound mode directly.
- 7.SLEEP:** Set the sleep time.
- 8. MTS:** Press to select the MTS mode.(for example, Nicam , BTSC, MONO, STEREO .eg)
- 9.P.MODE:** Select the different picture mode directly.
- 10.MENU:** Start system menu and return to upper menu.
- 11.SOURCE:** Input source conversion button.
- 12. ▲▼◀▶** Press ▼▲ button to select items.
Press ◀▶ button to adjust it.
- 13.ENTER:** To confirm the choice with the highlighted menu item.
- 14.EXIT:** Press to exit the OSD menu.
- 15.MIX:** TV and TXT pictures are mixed together (transparent background)

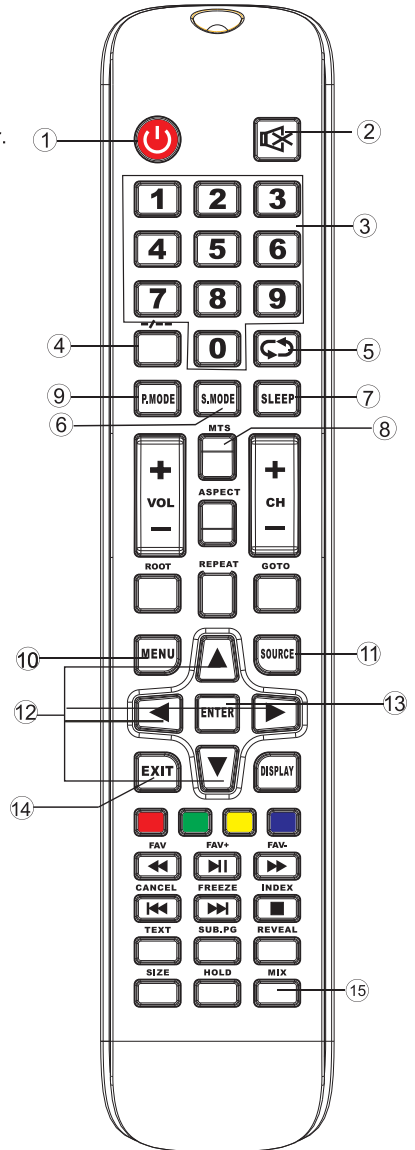

Battery Installation:

Remove the battery compartment lid on the rear of the remote control by sliding the lid down, then off. Put two AAA batteries inside the battery compartment with their + and - ends aligned as indicated. Do not mix old and new batteries or different types of batteries. Replace the battery compartment lid. Slide the lid until you hear it click into place.

Using the Remote Control:

Unless stated otherwise, the remote control can operate all the features of the TV.

Always point the remote control directly at the remote sensor in the front of the TV.

CAUTION:

Batteries installed in the unit should not be exposed to excessive heat such as sunshine, fire and the like.

Remote Controller

Descriptions of television remote control

- 16.VOL+:** Increase the volume.
- 17.ROOT:** When playing the photo or VIDEO, if you press ROOT, then it will stop playing and return to the current catalogue, in USB mode.
- 18.VOL-:** Decrease the volume.
- 19.FR:** Press to fast reverse in the USB mode.
FAV: Press to add or remove your favorite channels under TV menu
- 20.PLAY/PAUSE:** Press to PLAY/PAUSE in the USB mode. start recording and PAUSE, in USB mode.
CANCEL: When a page is selected in the mode of text, it may take some time before it becomes available, pressing the CANCEL key will return to the TV mode. When the required page is found, the page number will appear at the top of the TV picture, press the CANCEL key to return to the mode of text for you to browse this page.
- 21.PREV:** Press to skip the backward in the USB mode.
FAV+: Press to switch your favorite channels under TV menu
- 22.STOP:** Press to STOP in the USB mode.
INDEX: Request the Index page in Teletext mode.
- 23.GREEN/RED/YELLOW/CYAN:**
Teletex switch of the analog parts
Under the menu corresponding to the TV, press the button according to the color display to enter
RED:Exchange
GREEN:Insert
YELLOW:Copy
BLUE>Delete
- 24.CH+:** Increase the program.
- 25.REPEAT:** Repeat
- 26.CH-:** Decrease the program.
- 27.FF:** Press to fast forward in the USB mode.
FAV-: Press to switch your favorite channels under TV menu
- 28.SUBPAGE:** Press to access sub page.
- 29.NEXT:** Press to skip the forward in the storage mode.
FREEZE: Image still
- 30.GOTO:** Skip
- 31.REVEAL:** Reveal or Hide the hidden words.
- 32.SIZE:** Change the size of display in Teletext mode.
- 33.HOLD:** HOLD On or Off for current page display.
- 34.ASPECT:** Aspect function.
- 35.TEXT:** Switch On or Off the TELETEXT mode.

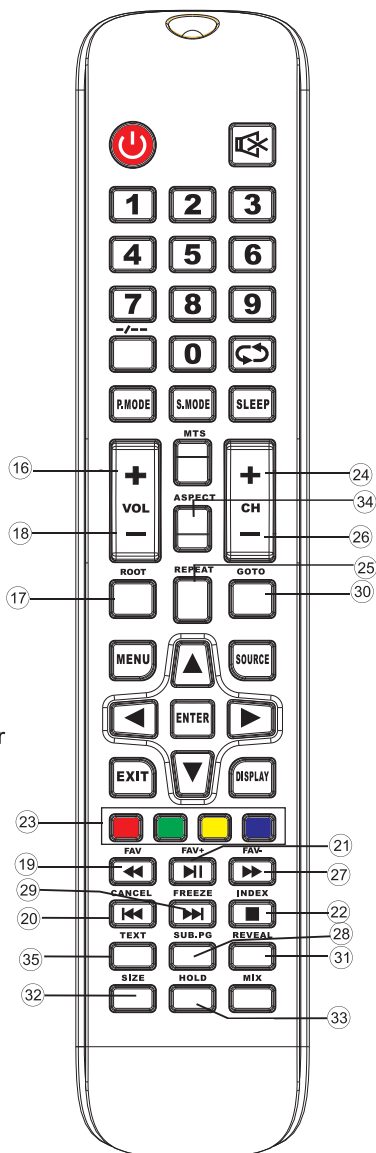



HDMI[®]
HIGH DEFINITION MULTIMEDIA INTERFACE

UPUTSTVO ZA UPOTREBU

LED TELEVIZORI Model:32DLE80

Hvala Vam što ste kupili ovaj uređaj.

FOX LED televizori prepoznaju se po odličnim tehničkim karakteristikama, kao i modernom, funkcionalnom i elegantnom dizajnu. Osim toga konstantna unapređenja u vidu postprodajne podrške, izuzetno efikasna i rasprostranjena servisna mreža čine da se ponosni vlasnici **FOX televizora** mogu osećati sigurno.

Napravili ste pravi izbor.

U nastavku slede uputstva za upotrebu. Nisu komplikovana, ali ih se morate pridržavati.

EN

SR

Sadržaj

Priprema uređaja

Sigurnosne informacije	2
Važne bezbednosne instrukcije	3

Instaliranje i povezivanje televizora

Montaža držača	4
Tipke televizora i interfejs	5
Dijagram za povezivanje eksternih uređaja	6
Instaliranje i povezivanje televizora	7
Instalacija postolja televizora	7

TV Meni

Izbor ulaznog signala	8
Meni kanala	8
Meni slike	9
Meni zvuka	10
Sat i vreme	10
Opcije	10

PC Meni

Displej	11
---------------	----

Media Meni

Media Meni	11
------------------	----

Ostale informacije

Pomoć	12
Specifikacije	13
Daljinski upravljač	14

Sigurnosne informacije

OPREZ!

Ovaj uređaj koristi visoki napon. Da bi spriječili rizik od strujnog udara nemojte ga otvarati. U slučaju potrebe, obratite se kvalifikovanom servisnom licu

If the TV any changes or coarse adjustment, electric shocks to be hurt, do not attempt to open a machine-maintenance, customer contact centres needed overhaul.



Simbol sa znakom uzvika u jednakostraničnom trouglu upozorava korisnika da pogleda instrukcije za korišćenje i održavanje (popravku) u dokumentaciji isporučenom sa uređajem.



Upozorenje
Simbol munje u jednakostraničnom trouglu upozorava korisnika na prisustvo opasnog neizolovanog napona unutar proizvoda koji može biti dovoljan za rizik od strujnog udara

Važne mere bezbednosti

1. Pročitajte ovo uputstvo.
2. Čuvajte ovo uputstvo.
3. Obratite pažnju na sva upozorenja
4. Pratite sva uputstva.
5. Nemojte koristiti aparat u blizini vode.
6. Čistite uređaj samo sa suvom krpom.
7. Ne blokirajte otvore za ventilaciju. Instalirajte TV prema uputstvima proizvođača.
8. Ne stavljajte uređaj pored izvora toplote kao što su radijatori, grejači, šporeti i slični aparati
9. Nemojte oštetiti priključni kabl. Ako priključni kabl ne odgovara vašoj utičnici, potražite savet od električara.
10. Kabl za napajanje ne sme biti pritisnut ili uklešten, posebno u delu oko utičnice ili mestu gde kabl izlazi iz aparata.
11. Samo koristiti priložene/dodatke preporučene od strane proizvođača
12. Koristite nosač za montiranje na zid ili stalak od proverenih proizvođača. Ako koristite pokretni stalak za postavljanje TV-a, pazite da ga ne prevrnete kada okrećete stalak.
13. Uvek isključite televizor tokom grmljavine ili kada ga ne koristite na duži period.
14. Sve servisne radnje na uređaju mora obavljati samo kvalifikovano osoblje, a posebno ako je oštećen kabl za napajanje, ako ste slučajno sipali tečnost ina uređaj, ukoliko je aparat bio izložen vlazi ili kiši.
15. Ovaj uređaj nije namenjen za ugradnju (u delove nameštaja ili pregradne zidove koji ne obezbeđuju dovoljnu ventilaciju) osim ako izričito nije navedeno od strane proizvođača.
16. Aparat mora biti zaštićen od prskanja (voda, ulje itd)
17. Ne stavljajte nikakve predmete na uređaj (posude sa vodom, upaljene sveće, itd).
18. Montiranje uređaja na zid ili plafon-uređaj mora da bude instaliran na zid ili plafon u skladu sa uputstvima datim od strane proizvođača.
19. Da bi se smanjio rizik od požara ili električnih šokova ne izlažite kiši i vlazi...
20. Glavni prekidač se koristi i za isključivanje uređaja iz naponske mreže, isključivanje uređaja bi trebalo biti lako i dostupno.
21. Nikad nemojte postavljati televizor, daljinski upravljač ili baterije u blizini izvora koji proizvode toplotu ili direktno izloženo sunčevoj svetlosti.
22. Držite sveće i druge zapaljive predmete dalje od televizora, daljinskog upravljača i baterija radi sprečavanja širenja požara.
23. USB terminal je preporučljivo koristiti pri standardu 2.0 ili višem.
24. Baterije ne trebaju biti izložene toploti kao što je sunce, vatra ili slični toplotni izvori.
25. Ova oprema je klase II i dizajnirana je na takav način da ne zahteva sigurnosni priključak na uzemljenje.
26. Maksimalna temperatura na kojoj se koristi uređaj je 45 stepeni celzijusa.
27. Maksimalna nadmorska visina pri kojoj uređaj radi ispravno je 2000m.
28. Ovo je servisno uputstvo sastavljeno od strane kvalifikovanih servisera. Da bi se smanjio rizik od električnog udara ne pokušavajte uređajem rukovati drugačije nego što je sadržano u uputstvu.

Montaža nosača

Pričvršćivanje televizora za zid

1. Postavite uređaj na stolu. Ispod njega postavite tkaninu kojom ćete zaštititi displej od grebanja i oštećenja.
2. Upotrebite šrafciğer za skidanje šrafova kojima je fiksirano postolje televizora. Nakon uklanjanja šrafova pažljivo uklonite postolje.
3. Postavite nosač koji se može fiksirati na zid prema potrebnim dimenzijama na pozicijama koje su prikazane na slikama 2 i 3.
4. Probušite četiri rupe na zidu i uz pomoć 4 šrafa pričvrstite nosač na zid.
5. Uz pomoć šrafciğerera pričvrstite šrafove na televizoru i na zidu.

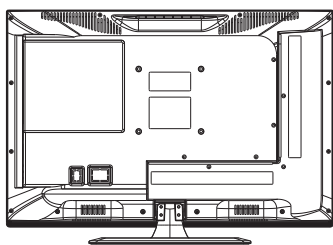

1

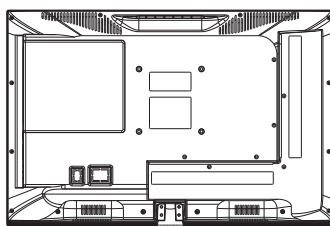

2

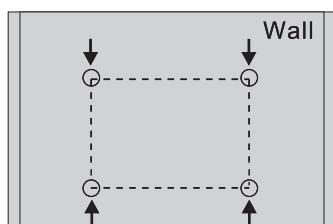

3

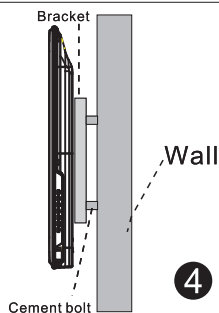

4

Beleška:

1. Nosač za TV je opcioni dodatak i on ne dođe u pakovanju.
2. Kada postavite TV oko njega ne smije biti drugih predmeta. Držite ga udaljenog od drugih predmeta..
3. Pratite uputstva za montiranje nosača.
4. Televizor zakačite na nosač koji odgovara njegovim dimenzijama.

NAPOMENA

UKOLIKO PROGRAM PRATITE PUTEM KABLOVSKE TELEVIJIZIJE PROVERITE DA LI JE PROPISNO IZVEDENO UZEMLJENJE I IZJEDNAČAVANJE POTENCIJALA NA KABLU VAŠEG KABLOVSKOG OPERATERA.

ZA OVE INFORMACIJE KONTAKTIRAJTE VAŠEG KABLOVSKOG OPERATERA.

Tipke na televizoru i interfejs

TV dugmici:

Napomena: Ključna uputstva su naveden u nastavku.









Displej/Sakrij taster ikone: kada se ikonica ne pojavljuje pritisnite taster, ikonica će se pojaviti kao slika prikazana gore, automatski se isključuje nakon 5 sekundi ne aktivnosti.

Icon selection: Short press the button, move the loop to the right, select the icon. Izbor ikona: Kratko pritisnite dugme, pomerite udesno, izaberite ikonu.











Odabir funkcija ikona: pritisnite i zadržite taster da bi se ostvarila funkcija ikone.

Opis ikona:

-  Isključeno ikona: odgovara dugmencetu "POWER" na daljinskom upravljaču.
-  Meni ikona: Odgovara "MENU" dugmencetu na daljinskom upravljaču.
-  Vodič ikona: Odgovara "SOURCE" dugmencetu na daljinskom upravljaču.
-  Pojačaj + ikona: Odgovara "VOL+" dugmencetu na daljinskom upravljaču.
-  Utišaj ikona: Odgovara "VOL-" dugmencetu na daljinskom upravljaču.
-  CH+ ikona: Odgovara "CH+" dugmencetu na daljinskom upravljaču.
-  CH- ikona: Odgovara "CH-" dugmencetu na daljinskom upravljaču.

Priključci

Napomena: Položaj i tip interfejsa su različiti za različite modele TV-a.

	AV ulaz Eksterni ulaz za AV signal		Slusalice izlaz Kada su slusalice uključene, zvučnici se automatski isključuju
	Čitackartica CI, zahteva CAM (modul uslovnog pristupa) koristi se za plaćenu TV Izlaz levog i desnog kanala audio/vide signala (neki modeli nemaju ovaj konektor)		USB ulaz Povežite USB uređaj za Reprodukciju fajlova ili čuvanje Sadržaja preko PVR funkcije.
	YpPb Pr ulaz Povežite sa kompozitnim terminalom vašeg DVD/VCR		SCART ULAZ Standard, podržava kompozitni i RGB ulaz.
	HDMI ulaz Digitalni ulaz iz HDMI konektora		Ulaz za PC analogni signal Za povezivanje PC-a
	ANT 75 Povežite TV ulaz antene, kabela (75/VHF/UHF)		PC AUDIO ULAZ Audio ulaz kada je VGA uključen.
	COAXIAL izlaz Priključite SPDIF prijemnik.		

Dijagram za povezivanje eksternih uređaja

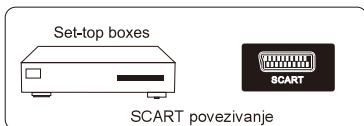
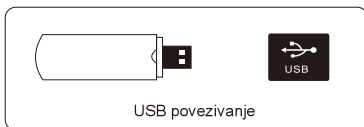
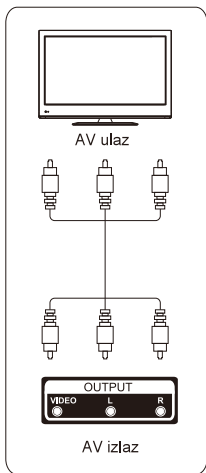
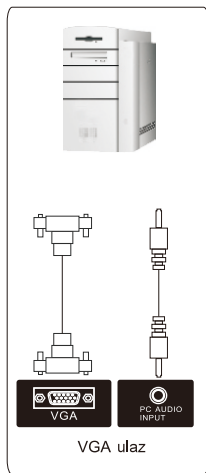
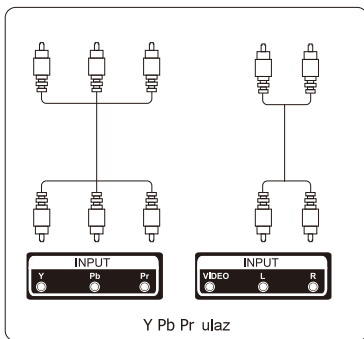
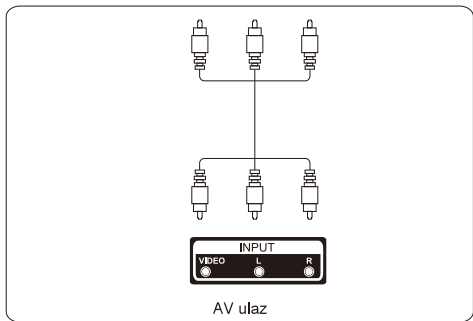
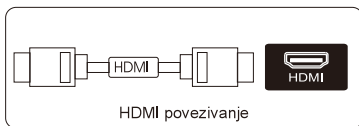
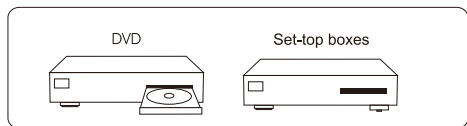

Instaliranje i povezivanje televizora

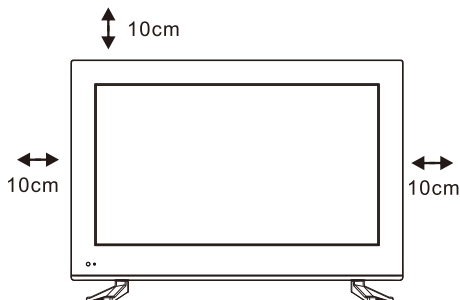

Podešavanje Vašeg TV-a

Televizor postavite na stabilno mesto koje može da izdrži njegovu težinu. Da bi izbegli moguće opasnosti ne postavljajte televizor na mesta koja su u blizini vode ili toplote (kao što je lampa, sveća, grejač) i ne blokirajte otvore za ventilaciju sa zadnje strane televizora.

Povezivanje antene i napajanja

1. Povežite antenski kabl u utičnicu za povezivanje antene sa zadnje strane televizora.
2. Za uključivanje kabla u TV (AC 100-240V~ 50/60Hz).

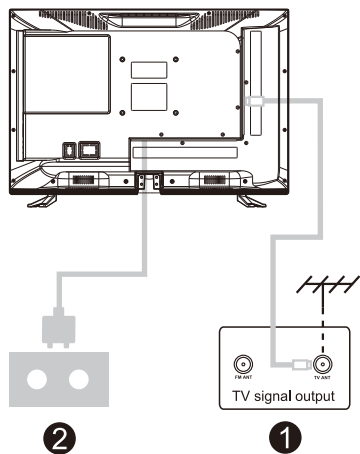

Uključite TV

3. Pritisnite tipku da uključivanje na uređaju, zelena signalna lampica će se uključiti. Ako je indikator u režimu mirovanja (svetli crveno), pritisnite dugme za uključivanje na daljinskom upravljaču da uključite TV.

Napomena:

Slika je indikativna.

Uputstvo za instalaciju postolja

1. Otvorite pakovanje i izvadite TV uređaj.
2. Da bi se izbegla oštećenja TV-a, prekrijte ekran mekim materijalom i stavite ga na ravan sto sa licem na dole i mekim materijalom ispod, bazu postolja pričvrstite sa šarafima.
3. Šarafe dobro pričvrstite kako bi se postolje dobro uklopilo uz TV
4. Instalacija je kompletna

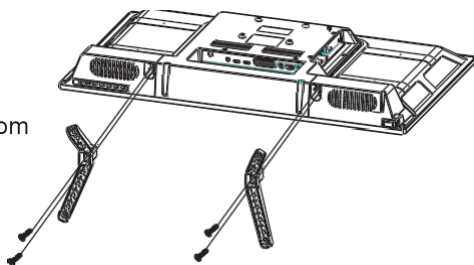

TV Meni

Izmene programa



Četiri obojene tipke su prečice za programiranje kanala.

Pritisnite ▼/▲ za označavanje kanala kojeg želite da izmenite:

Pritisnite crvenu tipku za brisanje kanala.

Pritisnite zelenu tipku za reimenovanje kanala, zatim pritisnite ◀/▶ da odaberete reč koju želite da promenite i ▼/▲ za odabir.

Pritisnite žutu tipku za pomeranje pozicije kanala, zatim pritisnite ▼/▲ da ga pomerite na željenu poziciju..

Pritisnite plavu tipku da bi preskočili odabrani kanal.

Tipkom Fav dodajete i uklanjate kanale sa liste omiljenih.

Meni slike



Mod slike

Odaberite opciju koju želite i pritisnite ENTER ili ◀/▶ za ulazak u podmeni, on će pokazati mod slike koji želite:

Dinamički/Standardni/Blag/Korisnički

Pritisnite PMODE na daljinskom upravljaču da direktno uđete u mod slike.

Kontrast

Podesite nivo bele boje na slici.

Zatamnjenje

Podešavanje zatamnjenje crnih sekcija na slici.

Boja

Podešavanje inteziteta boje.

Nijansa

Podešavanje nijanse (crvenem, zelene, plave) na slici.

Oštrina

Unapređivanje vidljivosti detalja slike.

Temperatura boje

Odabir željene temperature boje.

Redukcija buke

Isključeno/slabo/srednje/visoko
Možete očistiti signal odabirom nekih od opcija.

ECO Mod

Koristi se za Uključenje/Isključenje ECO moda.

TV Meni

Meni zvuka

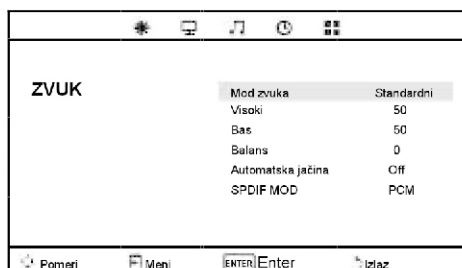

Mod zvuka

Standardan/Muzika/Film/Sport/Korisnički
(samo u ovom modu se visokotonac i
bas mogu podesiti)

Visokotonac

Podešavanje visokih frekvencija zvuka.

Bas

Podešavanje niskih frekvencija zvuka.

Balans

Podešavanje nivoa zvuka na levom i
desnom zvučniku.

Automatska jačina zvuka

Pritisnite za odabir Uključeno/Isključeno.

SPDIF MOD

Pritisnite ENTER/DESNO tipku za odabir.
Pritisnite GORE/DOLE tipke za odabir
Isključeno/Auto/PCM

Meni za vreme



Tajmer za spavanje

Odaberite vreme u minutima
(isključeno, 10 min, 20 min, 30 min,
60 min, 90 min, 120 min, 180 min,
240 min) da bi se TV automatski
isključio nakon podešenog vremena.

Automatsko spavanje

Odaberite vreme u satima
(isključeno, 3h, 4h, 5h) da bi se TV
automatski isključio nakon zadnje
operacije.

OSD tajmer

Odaberite vreme u sekundama
(5s, 10s, 15s, 20s, 25s, 30s,) da bi se
meni prikazivao nakon zadnje
operacije.

Opcije

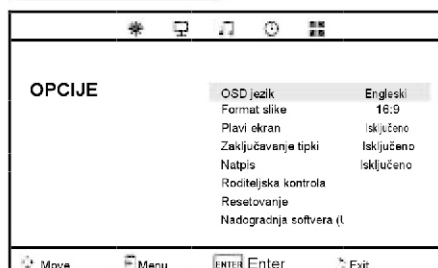

TV Meni

OSD jezik

Podešavanje OSD jezika.

Format slike

Odaberite odgovarajući format.

Plavi ekran

Odaberite plavu pozadinsku boju u slučaju kada nema signala

Zaključavanje tipki

Koristi se za sprečavanje dece od neočekivanog korištenja.

Shopping Mode

Izaberite uključeno (ON) ukoliko želite videti reklamni ugaoni natpis.

Reset

Povratak na fabrička podešavanja

Nadogradnja softvera (USB)

Odaberite fajl za nadogradnju softvera sa USB memorije i pritisnite ENTER

Media Meni

Media Meni

Boja ikone iznačava da li je TV detektovao USB memoriju. Plava: Da; Siva: Ne;



Pritisnite ◀/▶ da odaberete **Sliku/Muziku/Tekst** ikonu i pritisnite Enter za ulazak u USB memoriju.

PC Meni

Pozicija slike

SLIKA	
Automatiko prilagodavanje	
Horizontalna poz.	50
Vertikalna poz.	50
Sat	50
Faza	99

◀ Pomeri Meni ENTER/Enter ▶ Izlaz

Automatsko prilagodavanje

Horizontal Pos.

Pomeranje slike gore i dole.

Vertical Pos.

Pomeranje slike levo i desno.

Sat

Prilagodavanje internog sata.

Faza

Prilagodavanje internog signala.

Nema struje

Proverite da li je kabl za napajanje TV-a uključen. Ako i dalje nema struje isključite ga i nakon 60 sekundi uključite ponovo.

Signal nije pravilno primljen.

Moguće je da se prikaže dvostruka slika ili fantomska slika ako postoji bilo kakva visoka zgrada ili planina u blizini. Možete ručno podesiti sliku, slijedite uputstva kablovskog operatera ili promenite smer spoljnih kanala.

Nema slike

Proverite da li je antena sa zadnje strane televizora povezana ispravno. Pokušajte da izab erete neki drugi kanal i proverite da li je problem u nečem drugom.

Dobra slika, ali nema zvuka

Povećajte jačinu zvuka. Proverite da li je televizor u stanju pripravnosti i pritisnite ON. Zvuk se dobro čuje, ali boje nijesu realne ili nema slike

Proverite da li je antena na zadnjoj strani televizora povezana ili ne.

Poremećen nivo zvuka

Električni uređaj (fen npr.) može uticati na osećaj jačine zvuka. Isključite sve slične električne uređaje koji prave buku. Slika se deli. Verovatno lokacija antene nije dobra. Upotreba visoke antene može poboljšati kvalitet slike.

Televizor ne reaguje na daljinski upravljač

Usmerite daljinski upravljač direktno na senzor signala na TV-u. Ako televizor i dalje ne reaguje proverite da li ste skinuli folije iz daljinskog upravljača. Takođe proverite da li ste ispravno postavili baterije. Zamenite baterije novim.

Nema ulazni video signal (PC režim)

Proverite da li je kabl video signala ispravno povezan sa VGA ulazom. Provrte da li je kabl za video signal negde presavijen.

Ekran je svetao ili taman (PC režim)

Podesite kontrast ili osvetljenost iz glavnog menija.

Funkcija (PC režim) ne reaguje

Promenite postavku PC-a za kompatibilnu rezoluciju ekrana.

Prilikom povezivanje preko RCA se pojavljuju linije

Koristite kvalitetniji kabl za povezivanje

Problemi i dalje postoje

Izvućite kabl za napajanje i sačekajte oko 30 sekundi, onda ga ponovo postavite. Ako postoji neki problem sa televizorom, ne pokušavajte da ga popravite sami. Obratite se specijalizovanom servisu ili ovlašćenom uvozniku.

Tehnička specifikacija

Veličina ekrana	TV Sistem	Predefinisani kanali	Jačina zvučnika
16"	PAL/NTSC	PAL:0-199,NTSC:AIR 2-69 CABLE1-125	5W+5W
19"	PAL/NTSC	PAL:0-199,NTSC:AIR 2-69 CABLE1-125	5W+5W
20"	PAL/NTSC	PAL:0-199,NTSC:AIR 2-69 CABLE1-125	5W+5W
22"	PAL/NTSC	PAL:0-199,NTSC:AIR 2-69 CABLE1-125	5W+5W
24"	PAL/NTSC	PAL:0-199,NTSC:AIR 2-69 CABLE1-125	5W+5W
28"	PAL/NTSC	PAL:0-199,NTSC:AIR 2-69 CABLE1-125	8W+ 8W
32"	PAL/NTSC	PAL:0-199,NTSC:AIR 2-69 CABLE1-125	10W+ 10W
39"/40"	PAL/NTSC	PAL:0-199,NTSC:AIR 2-69 CABLE1-125	10W+ 10W
42"	PAL/NTSC	PAL:0-199,NTSC:AIR 2-69 CABLE1-125	10W+ 10W
43"	PAL/NTSC	PAL:0-199,NTSC:AIR 2-69 CABLE1-125	10W+ 10W
46"	PAL/NTSC	PAL:0-199,NTSC:AIR 2-69 CABLE1-125	10W+ 10W
50"	PAL/NTSC	PAL:0-199,NTSC:AIR 2-69 CABLE1-125	10W+ 10W
65"	PAL/NTSC	PAL:0-199,NTSC:AIR 2-69 CABLE1-125	10W+ 10W

Veličina ekrana	Potrošnja energije	Dodaci
16"	24W	Uputstvo za upotrebu x1 Daljinski upravljač x1 Naponski kabl x1 AAA Baterije x2
19"	36W/48W	
20"	36W/48W	
22"	36W/48W	
24"	36W/48W	
28"	36W	
32"	56W/65W/100W	
39"/40"	60W/70W/76W	
42"	67W/70W/95W/100W	
43"	65W/80W	
50"	100W/108W/135W	
55"	100W/135W/140W/160W	
65"	159W/165W/195W	

1. Dugme za uključivanje ili režim mirovanja
2. Dugme za stopiranje zvuka. Pritisnite dugme ponovo kako biste uključili zvuk opet. Možete da pritisnete i dugme VOL+.
3. 0-9 : Izaberite i pritisnite digitalna dugmad od 1-9 kako biste promijenili kanal dok gledate televiziju..
4. +/- Pritiskom na ovu tipku podešavate koliko cifri sadrži broj kanala koji želite uneti.
5. Povratak na prethodni program koji ste vi pratili.
6. S. Mode: Pritisnite za kretanje kroz različite zvučne režime.
7. SLEEP: Podesite vremenski period nakon kojeg želite da se televizor automatski isključi
- 8.MTS: Pritisnite da tražite NICAM režim
- 9.P. Mode: Pritisnite za kretanje kroz različite režime slike.
- 10.MENU: Omogućava Vam da upravljate menijem ekrana.
- 11.SOURCE: Otvara glavni meni, pritisnite da vidite izvore signala.
12. Pritisnite strelice gore i dole ili levo i desno da za selekciju.
13. ENTER: Korištenjem ovog dugmeta možete potvrditi željenu selekciju.
- 14.EXIT: Izlaz iz menija i podmenija i isključivanje zadate funkcije kod kanala
- 15.DISPLAY: Pritisnite za prikaz informacija o izvoru ili o kanalu.
- 16.VOL + : Povećanje jačine zvuka
- 17.ROOT: Pritiskom na ovu tipku, reprodukcija fajla će biti zaustavljena i vratiteće se na početni ekran u USB modu.
18. VOL- : Smanjivanje jačine zvuka
19. FR. Prsnite za brzo vraćanje unazad u USB modu.
- FAV: Pritisnite za dodavanje i brisanje omiljenih kanala u meniju.
- 20.PLAY/PAUSE: Pritisnite PLAY/PAUSE u USB modu da bi pokrenuli ili pauzirali fajl.
21. CANCEL: Kada ste izabrali stranu u tekstualnom režimu i sada nećete da se otvori, možete pritisnuti ovo dugme da otkazete komandu i vratite se u TV (12) funkciju. Kada je željena strana pronađena i otvorena pojavice se numerisana u gornjem uglu ekrana. Pritisnite da biste se vratili na stranicu za tekst koji želite da otvorite.
22. . PREV: Pritisnite da preskočite unazad u USB modu.
- FAV+: Pritisnite da pređete na omiljene kanale u meniju.
23. STOP: Pritisnite da bi zaustavili reprodukciju u USB modu.
- INDEX: Zatraži Index stranicu u Teletekst modu.
24. Dugmići u boji: uključuju teletekst u analognom
25. CH + : Pritisnite za odabir sledećeg kanala
26. REPEAT: Ponovi
27. CH-: Pritisnite za odabir prethodnog kanala
28. FF: Pritisnite za premotavanje unapred u USB modu.
- FAV-: Pritisnite da pređete na omiljene kanale u meniju.
29. SUBPAGE: Pritisnite da pristupite podstranici.
30. NEXT: Pritisnite za skok unapred u USB modu
- FREEZE: Zamrzavanje slike
31. GOTO: Preskoči
32. REVEAL: Otkrivanje i sakrivanje reči
33. SIZE: Promena veličine u Teletekst modu.
34. HOLD: Uključenje i isključenje prikaza trenutne stranice.
35. ASPECT: Promena formata slike
36. TEXT: Uključivanje i isključivanje Teletekst moda
37. MIX: TV i slike se prikazuju istovremeno sa providnom pozadinom.

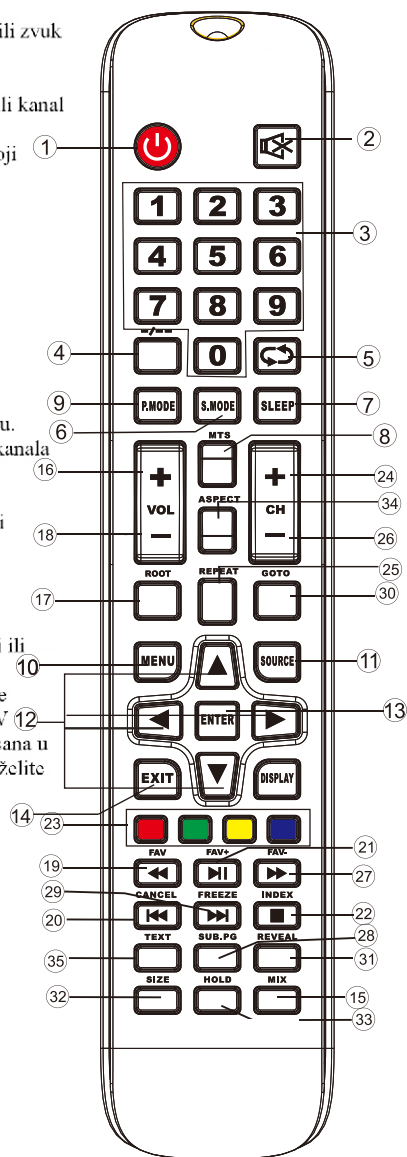

OPREZ: Baterije koje se nalaze u daljinskom upravljaču se ne smiju izlagati toploti. Na primer: suncu, vatri i slično...



Nadamo se da ste pažljivo pročitali uputstva i da ćete ih se pridržavati.
Za više informacija o FOX uređajima posetite našu internet stranicu:

www.foxelectronics.rs