



UPUTSTVO ZA UPOTREBU

LED TELEVIZORI Model:43DLE888

Hvala Vam što ste kupili ovaj uređaj.

FOX LED televizori prepoznaju se po odličnim tehničkim karakteristikama, kao i modernom, funkcionalnom i elegantnom dizajnu. Osim toga konstantna unapređenja u vidu postprodajne podrške, izuzetno efikasna i rasprostranjena servisna mreža čine da se ponosni vlasnici **FOX televizora** mogu osećati sigurno.

Napravili ste pravi izbor.

U nastavku slede uputstva za upotrebu. Nisu komplikovana, ali ih se morate pridržavati.



Android™ OS



CONTENTS

Safety Information	3
Important Safety Precautions	4
TV Buttons And Terminal Interface	5
External device connection diagram	6
Install And Connect TV	7
Launcher	8
Home	12
Settings	15
Multimedia	19
Source	22
Picture Menu	23
Sound Setup	26
Channel Setup	29
Lock	35
Time	36
Common	37
Help	39
Specifications	40
Romote Controller	41
Enviromental Protection	42

SAFETY INFORMATION

CAUTION

**RISK OF ELECTRIC SHOCK
DO NOT OPEN**

High voltages are used in the operation of this product. To reduce the risk of electric shock, do not remove cover of the cabinet, refer servicing to qualified service personnel.

If the TV any changes or coarse adjustment, electric shocks to be hurt, do not attempt to open a machine-maintenance, customer contact centres needed overhaul.



The exclamation point within an equilateral triangle is intended to alert the user to the presence of important operating instructions in the literature accompanying the appliance.

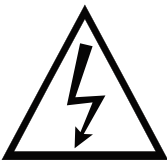

Warning
The lightning flash with arrowhead symbol within an equilateral triangle is intended to alert the user to the presence of uninsulated dangerous voltage within the product's enclosure that may be of sufficient magnitude to constitute a risk of electric shock to persons.

IMPORTANT SAFETY PRECAUTIONS

- 1) Read these instructions.
- 2) Keep these instructions.
- 3) Heed all warnings.
- 4) Follow all instructions.
- 5) Do not use this apparatus near water.
- 6) Clean only with dry cloth.
- 7) Do not block any ventilation openings. Install in accordance with the manufacturer's instructions.
- 8) Do not install near any heat sources such as radiators, heat registers, stoves, or other apparatus (including amplifiers) that produce heat.
- 9) Do not defeat the safety purpose of the polarized or grounding-type plug. A polarized plug has two blades with one wider than the other. A grounding type plug has two blades and a third grounding prong. The wide blade or the third prong are provided for your safety, If the provided plug does not fit into your outlet, consult an electrician for replacement of the obsolete outlet.
- 10) Protect the power cord from being walked on or pinched particularly at Plugs, convenience receptacles, and the point where they exit from the apparatus.
- 11) Only use attachments /accessories specified by the manufacturer.
- 12) Use only with the cart, stand, tripod, bracket, or table specified by the manufacturer, or sold with the apparatus. When a cart is used caution when moving the cart/apparatus combination to avoid injury tip-over.



- 13) Unplug this apparatus during lightning storms or when unused for long periods of time.

Caution:

- 14) To reduce the risk of fire or electric shock, do not expose this apparatus to rain or moisture.
- 15) The mains plug is used as disconnect device, the disconnect device shall remain readily operable.
- 16) The socket-out shall be installed near the equipment and shall be easily accessible.
- 17) This product should never be placed in a built-in installation such as a bookcase or rack unless proper ventilation is provided or the manufacture's instructions have been adhered to.
- 18) The apparatus shall not be exposed to dripping or splashing and that no objects filled with liquid, such as vases, shall be placed on the apparatus.
- 19) Do not place any sources of danger on the apparatus (e.g. liquid filled objects, lighted candles).
- 20) Wall or Ceiling Mounting - The appliance should be mounted to a wall or ceiling only as recommended by the manufacturer.
- 21)  Never place the TV, remote control or batteries near naked flames or other heat sources, including direct sunlight. To prevent the spread of fire, keep candles or other flames away from the TV, remote control and batteries at all times.
- 22) The USB terminal should be loaded with 0.5 A under normal operation.

These servicing instructions are for use by qualified service personnel only. To reduce the risk of electric shock do not perform any servicing other than that contained in the operating instructions unless you are qualified to do so.

- 23) The battery shall not be exposed to excessive heat such as sunshine, fire or the like.
- 24) This equipment is a Class II or double insulated electrical appliance. It has been designed in such a way that it does not require a safety connection to electrical earth
- 25) The maximum using environment temperature is 45 degrees.
The Maximum using altitude is 2000 meters

TV BUTTONS AND TERMINAL INTERFACE

TV Buttons

Note: The key instructions are subject to below.

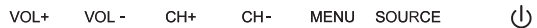

Display\ Hide key icon: When there is no button icon popping up, press the key, the key icon will pop up like the picture shows above, the key icon will automatically turn off after 5 seconds of inactivity.

Icon selection: Short press the button, move the loop to the right, select the icon.

Icon function selection: Long press the key to achieve the function of the selected icon.

Icon Description:

Power off Icon: Corresponding to the "POWER" button of remote .

Menu Icon: Corresponding to the "MENU" button of remote.

Source Icon: Corresponding to the "SOURCE" button of remote.

CH+ Icon: Corresponding to the "CH+" button of remote.











CH- Icon: Corresponding to the "CH-" button of remote.

Volume+ Icon: Corresponding to the "VOL+" button of remote.

Volume- Icon: Corresponding to the "VOL-" button of remote.

Terminal Interface

Note: The following are the various terminal interface, the actual position and arrangement, the number of different models may be different.

	AV input External AV Signal Input and Relevant Right/Left Sound Channel		PC AUDIO INPUT VGA input and audio input when VGA input
	Y Pb Pr input Connect to the composite terminal of your DVD NCR (Some models without this interface)		EARPHONE output When earphones are plugged in, speakers are disabled
	HDMI input Digital signal input from HDMI video connector.		USB input Connect a USB device here to play its media files or to record programs via the PVR function.
	ANT75 Connect the antenna/cable tv input (75NHF/UHF)		COAXIAL Connect the SPDIF receiver.
	VGA input PC analog signal input		RJ45 Connect the Internet.

EXTERNAL DEVICE CONNECTION DIAGRAM

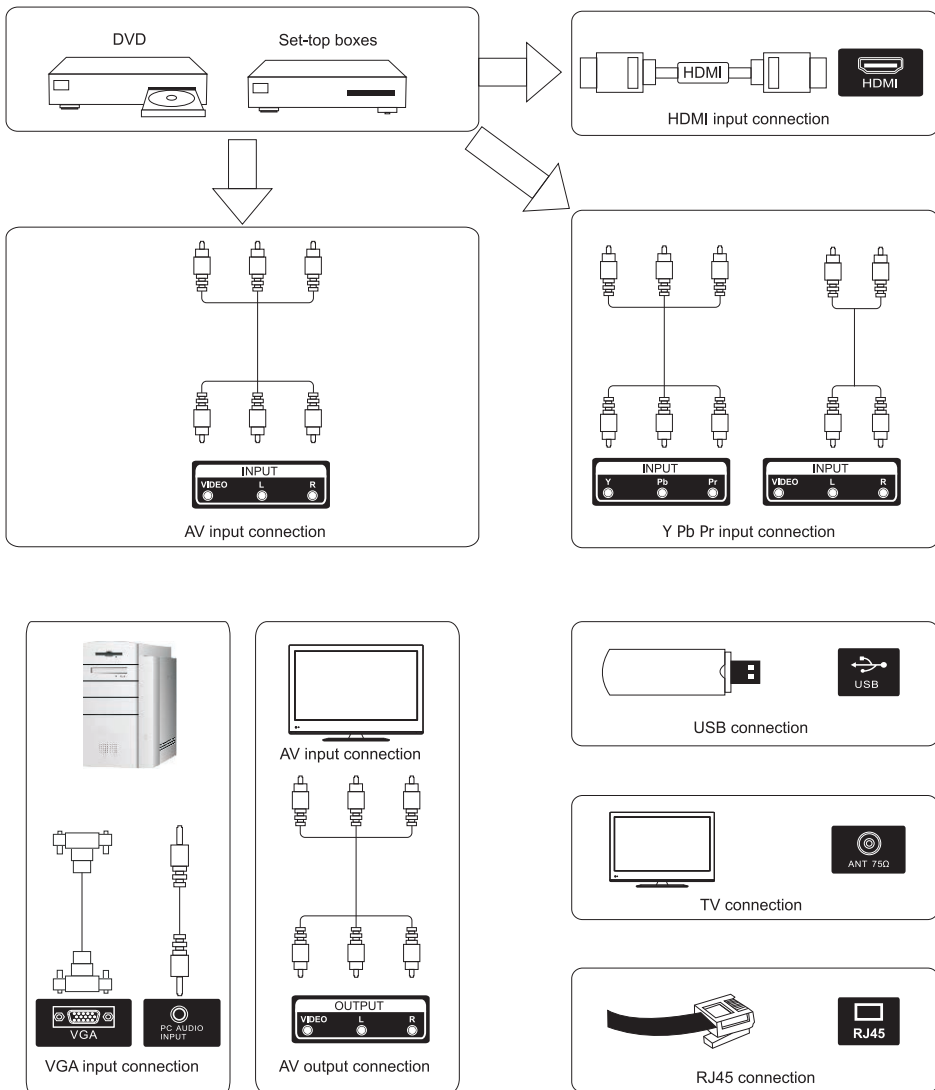

NOTE

IF YOUR PROGRAM ON TV WILL BE INCLUDED BY CABLE TELEVISIONS, PLEASE CHECK YOUR EARNING AND POTENTIAL EVALUATION ON THE CABLE OF YOUR CABLE OPERATOR. FOR THESE INFORMATION CONTACT YOUR CABLE OPERATOR.

INSTALL AND CONNECT TV

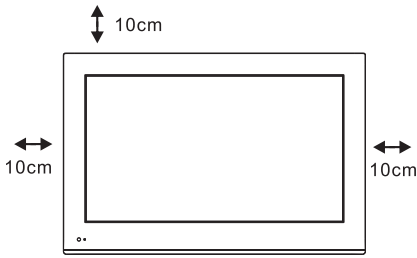

Set your TV

To put your TV in a firm place which can bear the weight of the TV.

To avoid danger, please don't expose the TV near water or heating place (such as light, candle, heating machine), do not block the ventilation at the back of TV.

Connect antenna and power

1. Connect the antenna cable to the antenna socket on the back of the TV.
2. To plug the power cord of TV (AC 100-240V~ 50/60Hz).

Turn on TV

3. Press the power button of the TV the indication light will turn to green. if it is on standby mode (the light is red), press the power button on the remote control to turn on the TV.

Note:

Picture for reference purposes only.

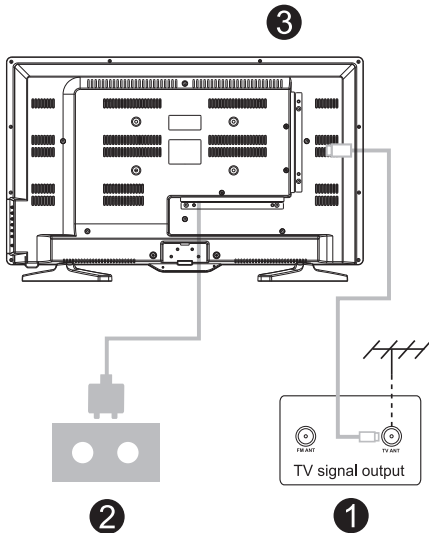

TV STAND INSTALLATION

1. Open the carton and remove the TV and scattered accessories and base (some models without base).
2. To avoid the injury of the TV, covered with a soft mattress, put it on the table, face down on a soft mattress, the base of the neck is fixed on the TV with screws.
3. Screw the base and connected to the TV.
4. The installation is complete.

Note:

Picture for reference purposes only.

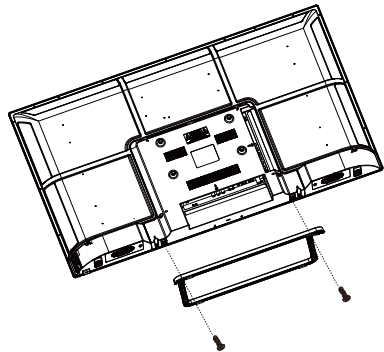

LAUNCHER

Connect an RF cable from the Tv's input called "RF-In" and to your TV Aerial socket
Press **ENTER** button to select the Start the setup.

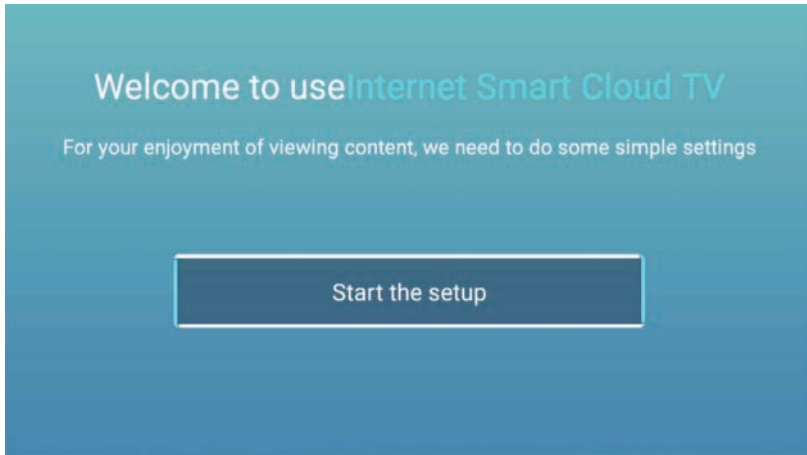

Press **【▼】 / 【▲】** button to select the language.
Press **OK** button to sure, and press **【▶】** button to setup country.



LAUNCHER

Press **【▼】 / 【▲】** button to select the country.

Press **OK** button to sure, and press **【▶】** button to select the time zone.



Press **【▼】 / 【▲】** button to select the time zone.

Press **【▶】** button to connect the WIFI/network.

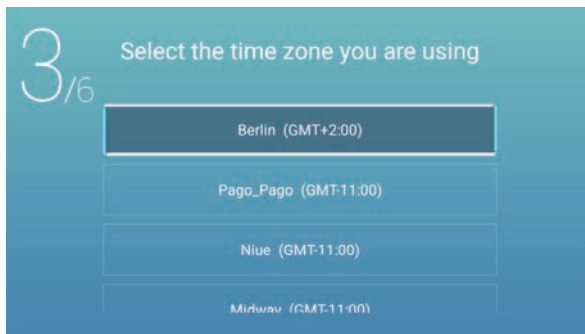

LAUNCHER

Press **OK** button to connect the WIFI/network.
Press **▶** button to connect the TV Assistant.



Use your mobile phone to scan the 2D code to connect the TV Assistant. (Refer to Eshare document for details)
Press **▶** button to select the input source.



LAUNCHER

Press [▼] / [▲] button to select the input source.

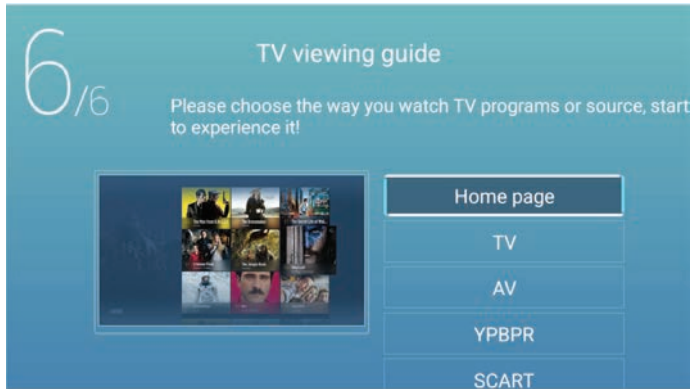

HOME

HOME

Press [◀] / [▶] button to select **HOME** in the main menu.

Press [▼] / [▲] button to select.

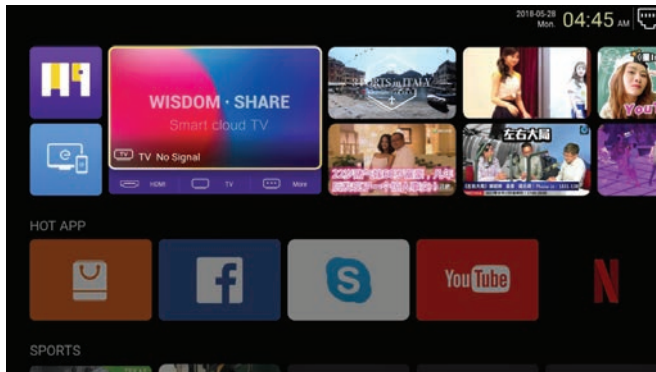

HOT APP

Press [▼] / [▲] / [◀] / [▶] button to to select **App Store** under **HOT APP** to add app.

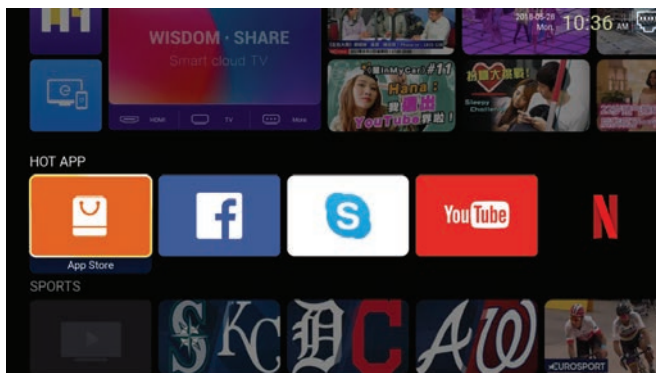

HOME

Press **[▼]** / **[▲]** / **[◀]** / **[▶]** to select **Apps** and press **ENTER** to add.

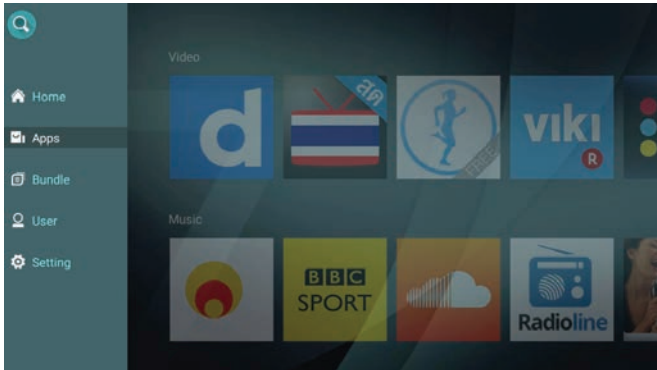

HOME

FAV APP

Press [▼] / [▲] button to select **FAV APP** to add your favorite apps.

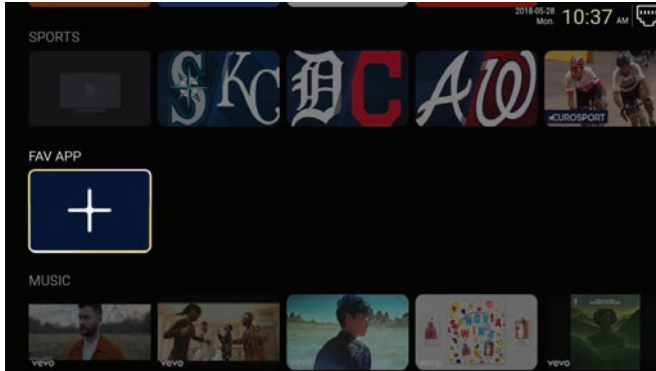

Press [▼] / [▲] / [◀] / [▶] to select your desired apps and press **ENTER** to add.

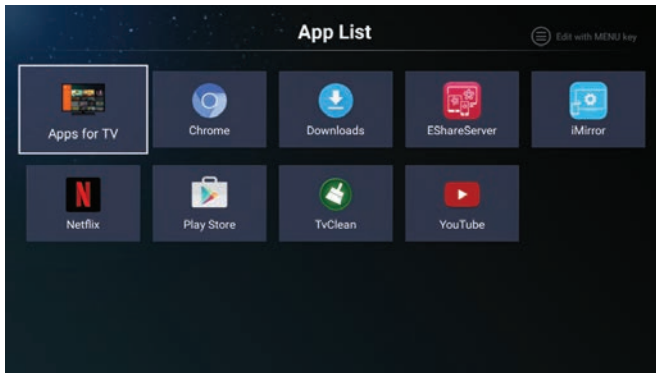

E-Share Server

E-Share is function for connect the Android mobile phone and iPhone to TV and show the mobile contents to TV screen wireless. Using remote control to find E-Share from scree, then you will see 2D code, and than scan it, now you can use this E-Share function.

iMirror

This app is used to reflect contents of computer into TV through internet.

SETTINGS

Settings

Press [▼] / [▲] / [◀] / [▶] button to enter **Settings**.

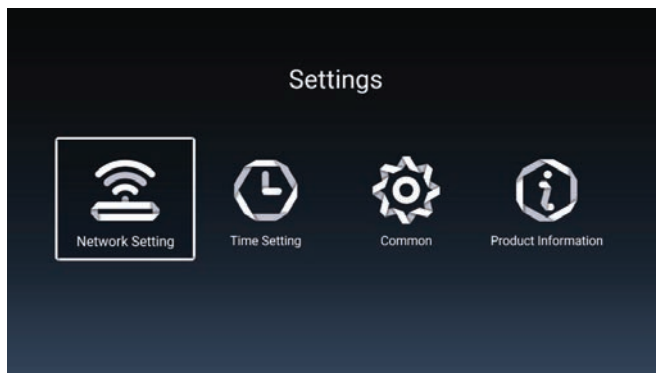
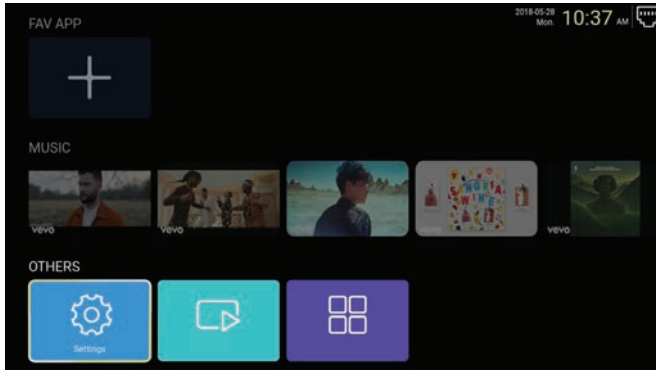

SETTINGS

Network Setting

Press [▼] / [▲] / [◀] / [▶] button to set the network.

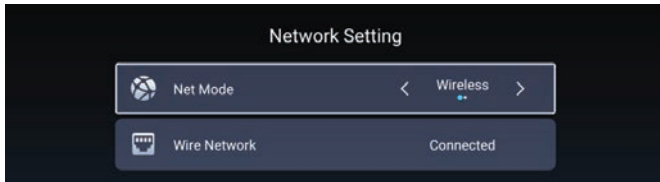

Time Setting

Press [◀] / [▶] button to select ON/OFF.

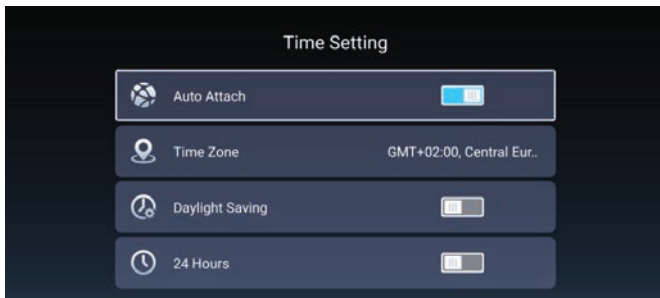

Common

Press [▼] / [▲] to select the following option to set.

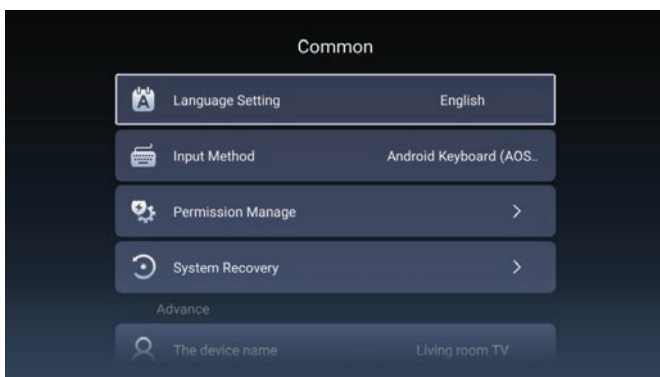

SETTINGS

Permission Manage

Press **【▶】** to enter and set the app permission.

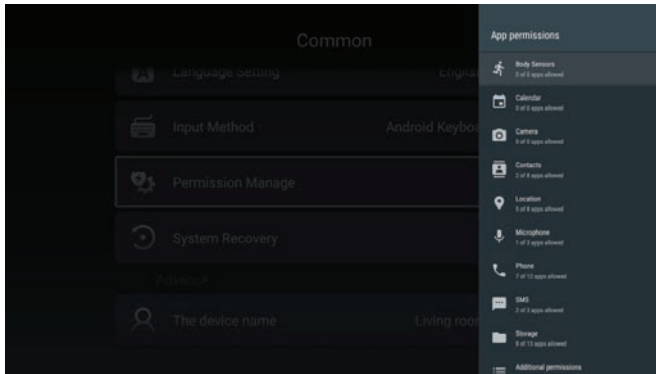

System Recovery





Press **【▶】** to enter and recover the system.

SETTINGS





Product Information

Enter **Product Information** to see the detailed information.

Product Information

 Internal storage of information	3.29 GB/8.00 GB
 Android Version	7.0
 Production Model	SMART_TV
 Firmware version	20180527_020140
 Number of processor cores	4Core

Product Information

 Production Model	SMART_TV
 Firmware version	20180527_020140
 Number of processor cores	4Core
Network information	
 Wire Net Mac Address	FF:FF:FF:FF:F3
 WireLess Net Mac Address	74:72:B0:BE:13:4B

MULTIMEDIA

Multimedia

Press **▼** / **▲** / **◀** / **▶** to select **Multimedia** in the **Home** page and press **ENTER** button to enter.

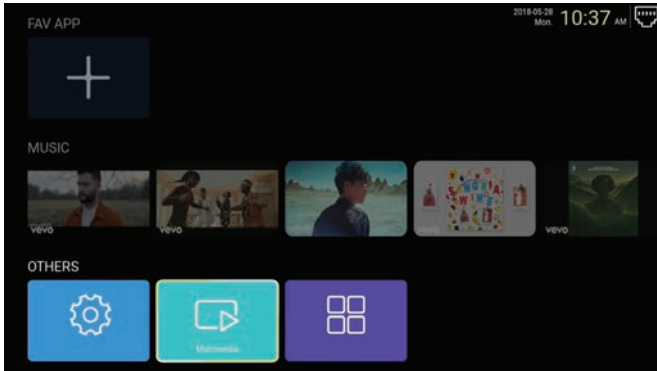

Video

Press **◀** / **▶** to select video.

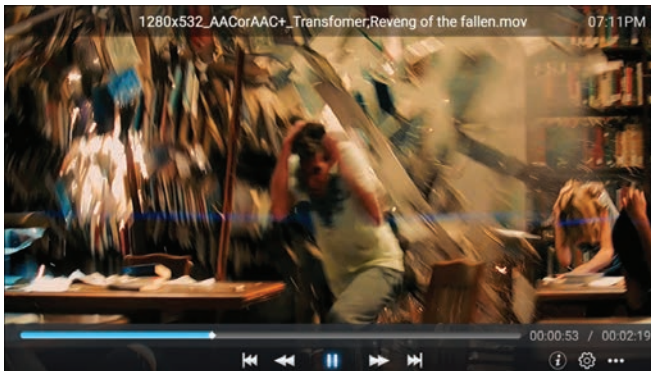

Press to play previous movie.



Press to play fast backward.



Press to stop/play the movie.



Press to play fast forward.



Press to play next movie.

MULTIMEDIA



Press to view the information of the movie.(Resolution/Size/Duration/Bitrate)



Press to set the Audio Track/Select Subtitle/Region Language/Play Mode/Aspect Ratio.



Press to select the movie to play.

Photo

Press ◀ / ▶ to select photo.



Press to rotate anticlockwise the picture.



Press to stop/play the picture.



Press to rotate clockwise the picture.



Press to view the information of the picture.(Size/Resolution)



Press to set the Play Mode(Aspect Ratio/Playback duration).



Press to select the photo to play.

MULTIMEDIA

Music

Press ◀ / ▶ to select music.



Press to play fast backward.



Press to stop/play the music.



Press to play fast forward.



Press to view the information of the music.(Mine Type/Size/Bittrate)



Press to set the Play Mode(Repeat All/Repeat One/Random/None).



Press to select the music to play.

SOURCE

Source

Press **【◀】 / 【▶】** button to select **Source** in the main menu.

Press **【▼】 / 【▲】** button to select.

Press **ENTER** to select source..

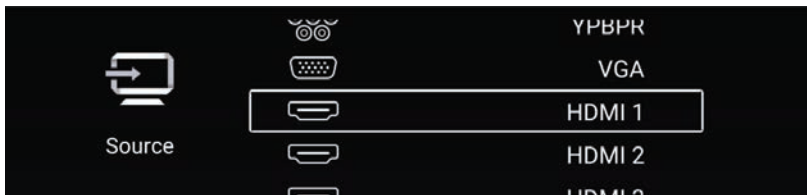
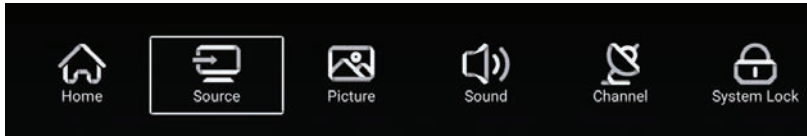

PICTURE

Picture

Press **【◀】 / 【▶】** button to select **Picture** .Press **ENTER** to enter setting.

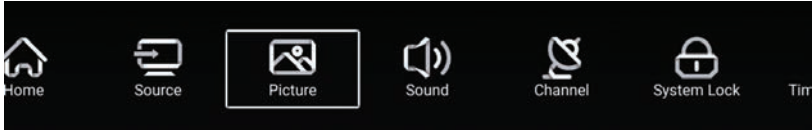

1. Press **【▼】 / 【▲】** to select: **Picture Mode/Contrast/Brightness/Color/Sharpness/Backlight/Noise Reduction/Aspect Ratio/Color Temp/More Settings**

2. Press **【◀】 / 【▶】** to adjust or select.



PICTURE

Picture Mode

Press [▼] / [▲] button to select **Picture Mode**, and then press [◀] / [▶] button to select.
(Option: Standard, Movie, Vivid, Energy Saving, User).

Standard	The default mode, to make users experience high-quality images under normal light.
Movie	This mode is more suitable for watching movies.
Vivid	Image colors more beautiful, more vivid picture.
Energy Saving	Reduce screen brightness, improved contrast for energy saving.
User	User-defined picture settings.

Contrast/Brightness/Colour/Sharpness/Backlight

Press [▼] / [▲] to select, and press [◀] / [▶] to adjust

Contrast	Adjust image contrast.
Brightness	Adjust image brightness.
Color	Adjust image color density.
Sharpness	Adjust the image edge sharpness.
Backlight	Adjust the screen backlight brightness.

Noise Reduction

Setting the option to eliminate image noise intensity.

Press [▼] / [▲] to select **Noise Reduction**, and press [◀] / [▶] to select.
(Option: Off, Low, Medium, High, Auto).

Aspect Ratio

Adjust the screen display size.

Press [▼] / [▲] to select **Aspect Ratio**, and press [◀] / [▶] to select.
(Option: Auto/16:9/4:3/zoom1/zoom2/)

Note: This option only available when there is signal for TV.

Color Temp

Adjust the overall color of the image.

Press [▼] / [▲] to select **Colour Temperature**. press [◀] / [▶] to select.
(Option: Cool, Normal, Warm).

Cool	Produces a gentle blue-hued image.
Normal	Produces a vivid image.
Warm	Produces a red-hued image.

PICTURE

More Settings

Press [▼] / [▲] to select **More Settings**.

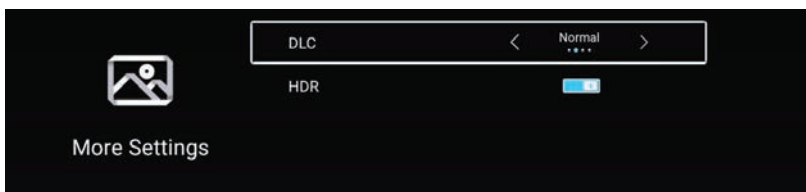

DLC

Press [▼] / [▲] to select **DLC**, and press [◀] / [▶] to select **Dark/Normal/Bright/Off**.

HDR

Press [◀] / [▶] to set ON/OFF.

SOUND

Sound

Press **MENU** button to display the main menu. Press **◀** / **▶** button to select **Sound** in the main menu.

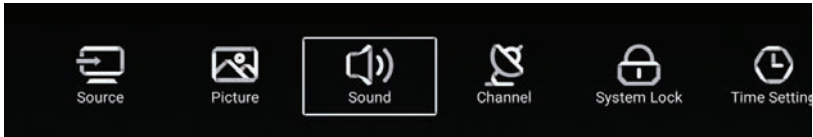

Press **▼** / **▲** to select: **Sound Mode/Bass/Treble/Balance/AVC/Audio Description/Hearing Impaired/More settings.**

Press **ENTER** / **◀** / **▶** to select or adjust.

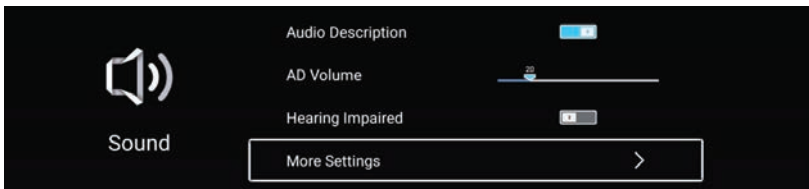
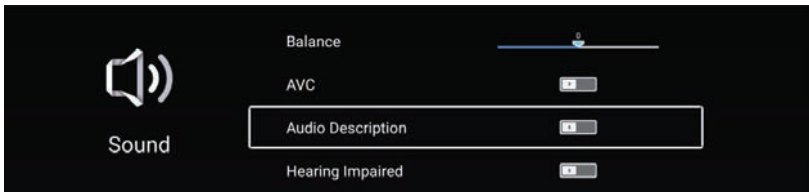
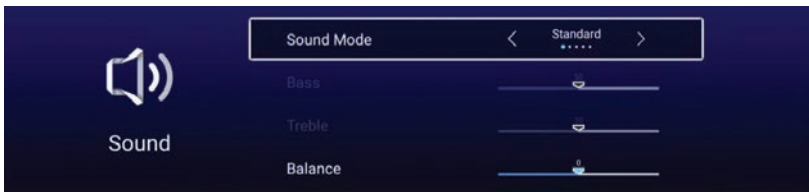

SOUND

Sound Mode

Press **【▼】 / 【▲】** button to select **Sound Mode**, then press **【◀】 / 【▶】** button to select.
(Option: Standard, Music, Theater, News, User).

Standard	Produces a balanced sound in all environments.
Music	Preserves the original sound. Good for musical programs.
Theater	Enhances treble and bass for a rich sound experience.
News	Enhanced voice.
User	Select to customize picture settings.

Bass Adjust the bass.

Treble Adjust the treble.

Balance Adjust the left and right channel output balance.

Press **【▼】 / 【▲】** button to select **Balance**, then press **【◀】 / 【▶】** button to adjust.

AVC

Press **【▼】 / 【▲】** button to select **AVC**, then press **【◀】 / 【▶】** button to choose ON/OFF.
After opening the AVC, once the volume is set and regardless of any difference TV version printed on each channel, it can make the speaker volume remained stable.

Audio Description

Press **【◀】 / 【▶】** button to set ON/OFF. If setting ON, press **【◀】 / 【▶】** to adjust the **AD Volume**.

Hearing Impaired

Press **【◀】 / 【▶】** button to set ON/OFF.

Note: The Audio Description and Hearing Impaired only available when there is signal for TV.

SOUND

More Settings

Press **【▼】 / 【▲】** button to select **More Settings**, and then press **【▶】** button to enter.

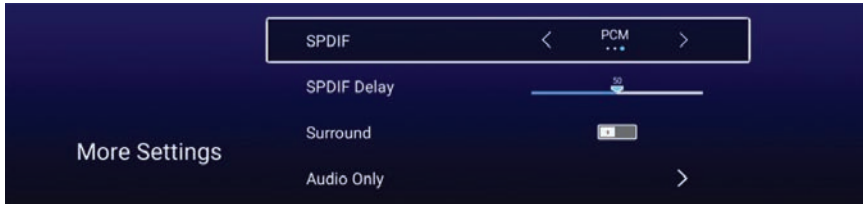

SPDIF

Press **【▼】 / 【▲】** button to select **SPDIF**, and then press **【◀】 / 【▶】** button to choose OFF/RAW/PCM.

SPDIF Delay

Press **【▼】 / 【▲】** button to select **SPDIF Delay**, and then press **【◀】 / 【▶】** button to adjust.

Surround

Achieve better surround sound effect.

Press **【▼】 / 【▲】** button to select **Surround**, and then press **【◀】 / 【▶】** button to choose ON/OFF.

Audio Only

Only plays sound without the screen opening displayed.

Press **【▼】 / 【▲】** button to select **Audio Only**, and then press **【◀】 / 【▶】** button to choose ON/OFF.

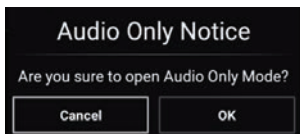

CHANNEL

Channel

Press **MENU** button to display the main menu. Press **【◀】 / 【▶】** button to select **Channel** in the main menu.

Press **【▼】 / 【▲】** button to select. Press **ENTER / 【◀】 / 【▶】** to enter.

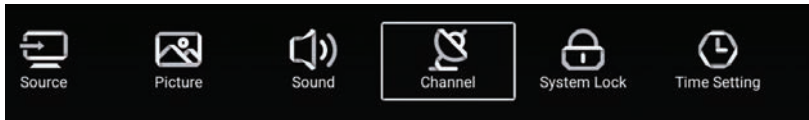

Antenna Type-Air

Select the **Air/Cable/Satellite** to tune.

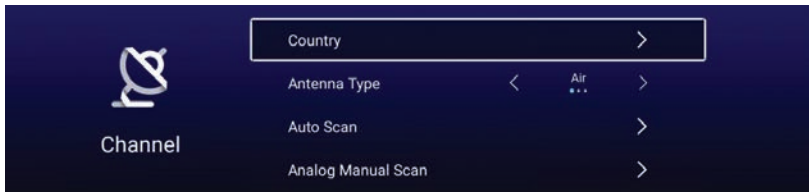

Country

Press **【▶】** to set the country to tune.

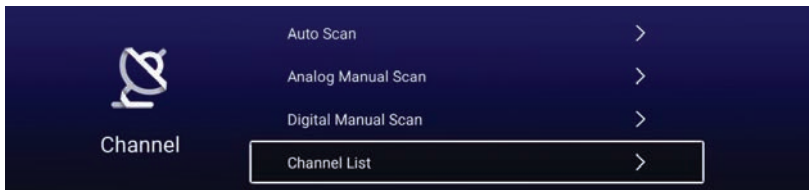

Auto Scan

Press **【▼】 / 【▲】** button to select **Auto Scan**, and press **ENTER** to start Auto Scan.

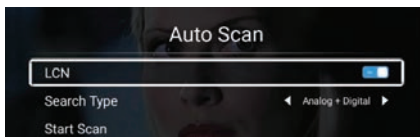

CHANNEL

Analog Manual Scan

Press [▼] / [▲] button to select **Analog Manual Scan**, and press **ENTER** to start Scan.

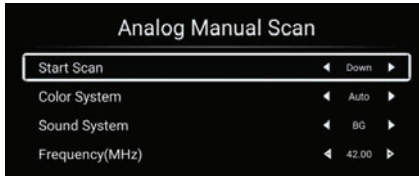

Digital Manual Scan

Press [▼] / [▲] button to select **Digital Manual Scan**, and press **ENTER** to start Scan.

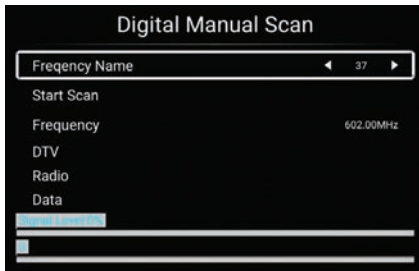

Channel List

Press [▼] / [▲] button to select **Channel List** to view the channels, and press **MENU** button to edit the channel. (Skip/Delete/Fav).

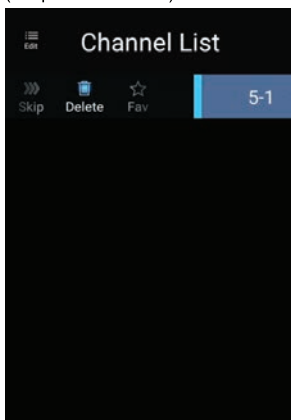



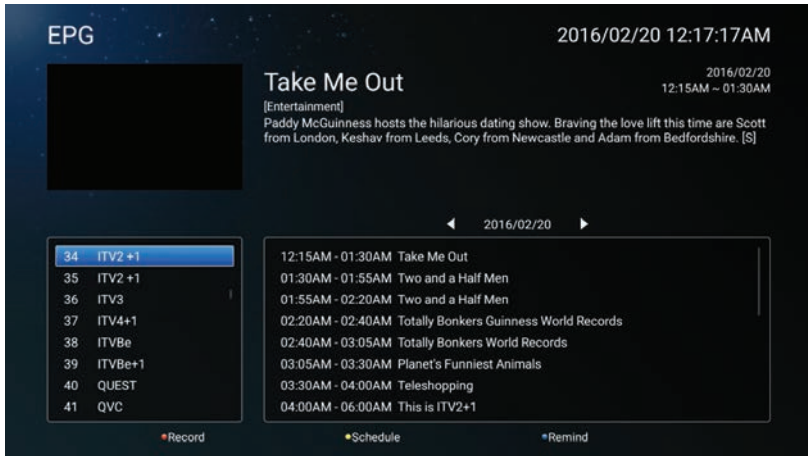

CHANNEL

EPG

Press [▼] / [▲] button to select **EPG**.



-  **Record** Set the time and channel to record automatically.
-  **Schedule** View the schedule, which have been set to record.
-  **Remind** Set the time to remind you when it will record the program.
-  Press the button on your Remote control to record the program immediately.
-  Press the button on your Remote control to stop record the program immediately.

Antenna Type-Cable

Select the **Air/Cable/Satellite** to tune.

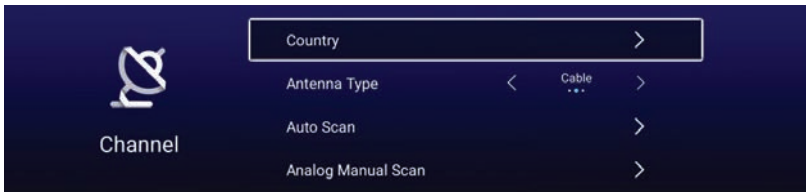

Country

Press [▶] to set the country to tune.

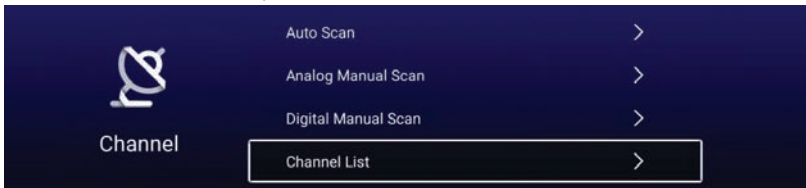

CHANNEL

Auto Scan

Press [▼] / [▲] button to select **Auto Scan**, and press **ENTER** to start auto scan.

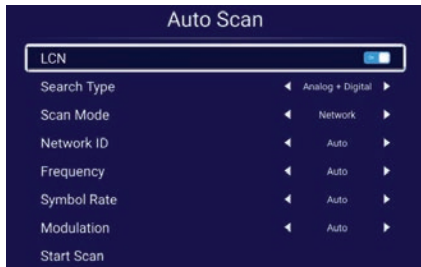

Analog Manual Scan

Press [▼] / [▲] button to select **Analog Manual Scan**, and press **ENTER** to start Scan.

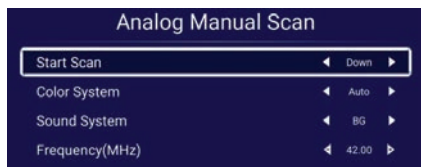

Digital Manual Scan

Press [▼] / [▲] button to select **Digital Manual Scan**, press **ENTER** to start Scan.

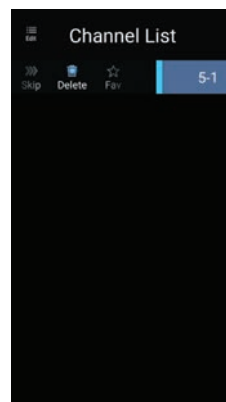
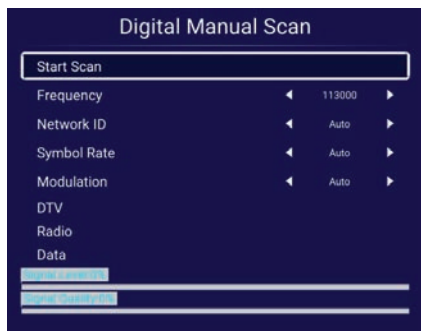

Channel List

Press [▼] / [▲] button to select Channel List to list, press **MENU** button edit the channel (Skip /Delete /Fav).

CHANNEL

Antenna Type-Satellite

Select the Air/Cable/Satellite to tune.

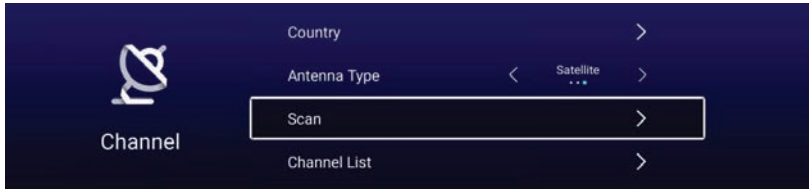

Country

Press **[▶]** to set the country to tune.

Scan

Press **[▼]** / **[▲]** button to select **Scan**.

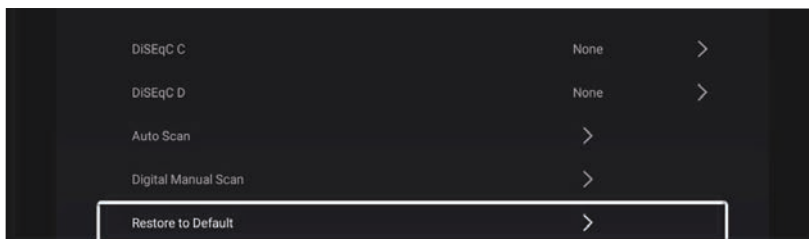
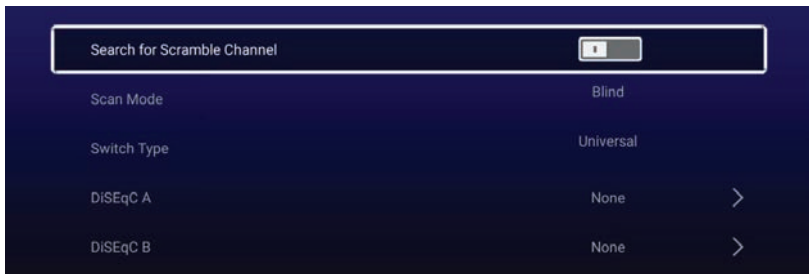

CHANNEL

Auto Scan

Press [▼] / [▲] button to select **Auto Scan** to search the program automatically.

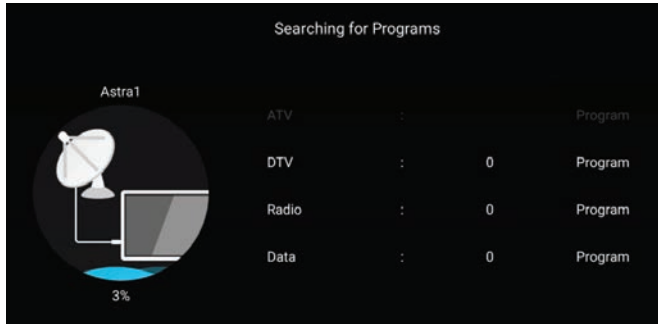

Digital Manual Scan

Press [▼] / [▲] button to select **Digital Manual Scan** to search the program you set.

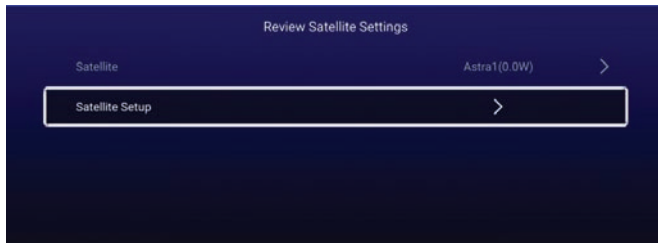

Restore to Default

Press [▼] / [▲] to select **Restore to Default** to determine whether to clean your satellite channels.

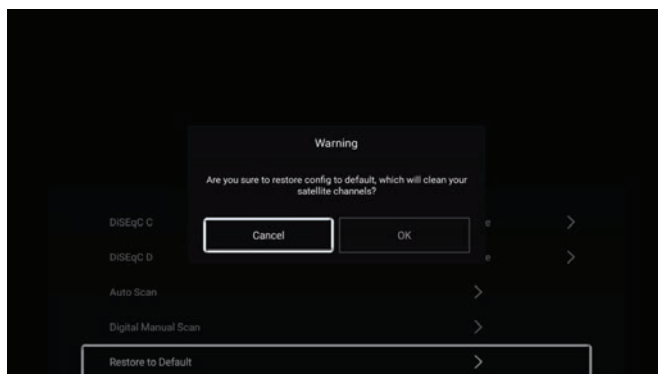

SYSTEM LOCK

System Lock

Press **MENU** button to display the main menu. Press **【◀】 / 【▶】** button to select **System Lock**.

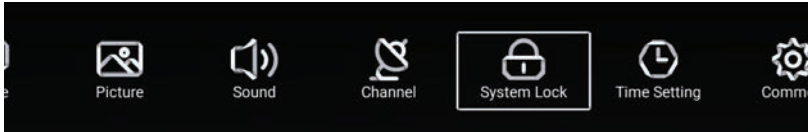

Press **【▼】 / 【▲】** button to select **Change Password/System Lock**. Press **ENTER / 【◀】 / 【▶】** to enter.

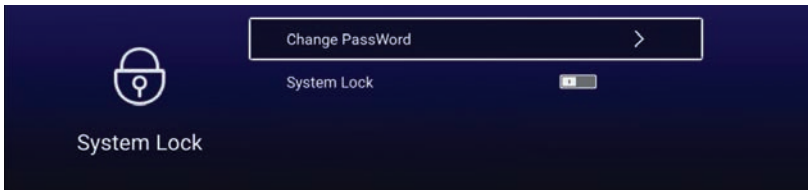

Change Password

Press **【▼】 / 【▲】** button to select **Change Password**.

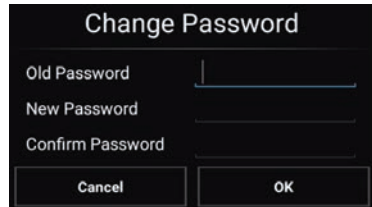

System Lock

Press **【▼】 / 【▲】** button to select **System Lock**.

Parental Control

Some program may not be suitable for children, through **Parental Control** set-up, parents can shield unsuitable show automatically.

Press **【▼】 / 【▲】** button to select **Parental Control**.

Press **【▼】 / 【▲】** button to select Off/4/5/6/7...18.(Age of children)

This function only available when there is signal for TV.

Keypad Lock

Press **【▼】 / 【▲】** button to lock the keypad.

Note: This function is available when the System Lock is on.

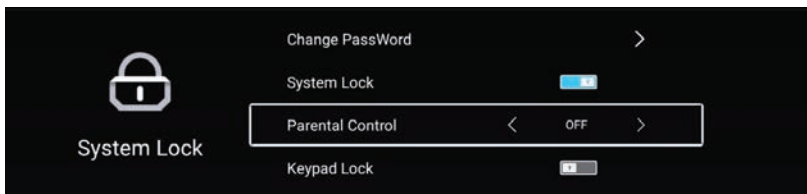

TIME SETTINGS

Time Setting

Press **MENU** button to display the main menu. Press **【◀】 / 【▶】** button to select **Time Setting** in the main menu.



Press **【▼】 / 【▲】** button to select: **OSD Timer/Sleep Timer/Autostandby Timer**.
Press **ENTER / 【◀】 / 【▶】** to enter.



OSD Timer

Press **【▼】 / 【▲】** button to select **OSD Timer**, Press **【◀】 / 【▶】** to select.
(Option: off,5sec,15sec,30sec).

Sleep Timer

Press **【▼】 / 【▲】** button to select **Sleep Timer**, Press **【◀】 / 【▶】** to select.
(Option: off,15min,30min,45min,60min,90min,120min,240min).

Autostandby Timer

Press **【▼】 / 【▲】** button to select **Autostandby Timer**,
(Option: off,3hour,4hour,5hour)

COMMON

Common

Press **MENU** button to display the main menu. Press **【◀】 / 【▶】** button to select **Common** in the main menu.



Press **【▼】 / 【▲】** button to select: **Blue Screen/Audio Language 1st/Audio Language 2nd/ Subtitle Language 1st/Subtitle Language 2nd/HDMI CEC/Menu Reset**
Press **ENTER / 【◀】 / 【▶】** to enter.

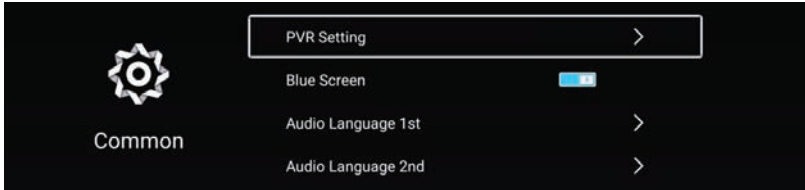

PVR Setting

Press **【▼】 / 【▲】** button to select **PVR Setting**.
Press **【◀】 / 【▶】** to select **Disk/Format/Record List/Schedule List**.
Note: This option only available when there is signal for TV.

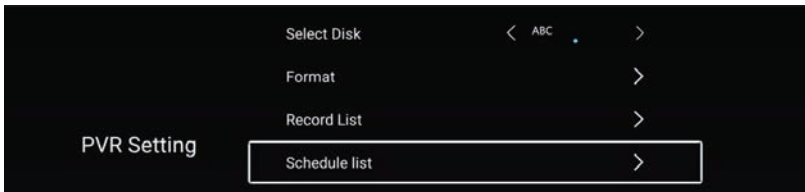

Blue Screen

Press **【▼】 / 【▲】** button to select **Blue Screen**.
Press **【◀】 / 【▶】** to select ON/OFF.

Audio Language 1st /Audio Language 2nd/ Subtitle Language 1st/Subtitle Language 2nd

Press **【▶】** button to select your desired language. Note: Only available when there is signal for TV.

COMMON

HDMI CEC

Press [▼] / [▲] button to select **HDMI CEC**.

Press [◀] / [▶] to select ON/OFF.

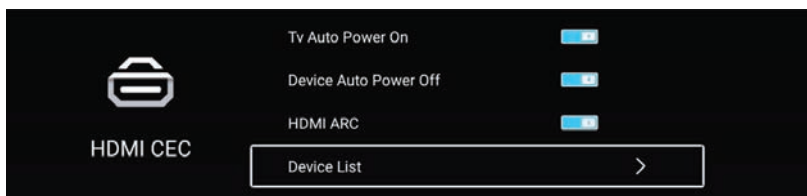

Device List

Press [▶] button to view all device.

Menu Reset

Press [▶] button to determine whether to reset the Menu.



HELP

No power	<ul style="list-style-type: none"> ● Check if the AC cord of TV is plugged in or not. If there's still no power, please disconnect the plug, and reconnect to the socket after 60 seconds. Turn the power back on.
Signal not received properly	<ul style="list-style-type: none"> ● Double or phantom images may appear on your TV if there are high buildings or mountains close to where you are. You can adjust the image thru manual operation: consult instruction of vernier regulation, or adjust the direction of the external antenna. ● If you use an indoor antenna, under certain circumstances signal reception may be more difficult. Adjust the direction of the antenna for optimum reception. If this does not improve reception, you may have to switch to an external antenna.
No picture	<ul style="list-style-type: none"> ● Check if the antenna at the back of the TV is connected properly. ● View other channels to see if the problem still occurs.
Video appears with no audio	<ul style="list-style-type: none"> ● Try increasing the volume. ● Check if the TV's sound is on mute or not.
Audio is present, but video does not appear or is discolored	<ul style="list-style-type: none"> ● Try adjusting the contrast and brightness.
Static noise affects video and audio quality	<ul style="list-style-type: none"> ● Check if the antenna at the back of the TV is connected properly.
Broken lines on screen	<ul style="list-style-type: none"> ● Electrical appliances such as hair dryers or vacuums etc. may be interfering with your TV set. Switch these appliances off.
Remote doesn't work	<ul style="list-style-type: none"> ● Make sure the plastic bag which came with the remote control is removed. Try using the remote in a shorter distance from the TV. Check if the placement of the batteries is correct, or try using new batteries with the remote control. ● The TV will go into Standby mode if it receives no response in a few minutes.
No video (PC mode)	<ul style="list-style-type: none"> ● Please check if the cable is connected to the VGA port correctly, or if the cable is bent in some places.
Vertical line blinking (PC Mode)	<ul style="list-style-type: none"> ● Enter the main menu, and adjust the vertical placement to eliminate the vertical line.
Horizontal tearing (PC Mode)	<ul style="list-style-type: none"> ● Adjust the horizontal placement of the screen to clear any horizontal lines.
Screen is too bright or dark (PC Mode)	<ul style="list-style-type: none"> ● Adjust the brightness or contrast in the main menu.
No response from the PC	<ul style="list-style-type: none"> ● Check if the PC's display resolution is set to a compatible resolution for the TV.
Lines appearing when a device is connected to the RCA port	<ul style="list-style-type: none"> ● Make sure you are using a cable of good quality.
Problems are unresolved	<ul style="list-style-type: none"> ● Unplug the power cable and wait for 30 seconds, then reconnect to the socket. If problems still persist, do not attempt to repair the TV by yourself. Kindly contact the service center.

Do not leave your TV displaying a static image, whether it is from a paused video, menu screen, etc. for an extended period of time, doing so will damage the display and may cause image burn-in.

SPECIFICATIONS

Aspect Ratio	16 : 9
System	PAL/SECAM BG/DK/I, DVB-T/T2+C, NTSC Playback
Base impedance	75 Ω (Unbalance)
Receiving TV Band	All Channels Receiveable
AC Supply Voltage	100-240V~ 50/60Hz

Note: Part of the design and the specification may be changed without prior notice.

INFRA-RED REMOTE CONTROL

Features: Full function remote control

Effective Distance Power: 8 metres

Power Supply: DC 3V (Two batteries, size AAA, recommend use alkaline type batteries)



Manufactured under license from Dolby laboratories.

Dolby, Dolby Audio, and the double-D symbol are trademarks of Dolby laboratories.

	Operation Frequency	Transmitting Power
WiFi	2400~2483.5	Less Than 100mW

NOTE:

DO NOT SUPPORT ALL MOBILE DEVICES THE TV FUNCTION WIRELESS DISPLAY.
PLEASE KEEP YOUR OWN MOBILE DEVICE SUPPORT TO THIS FUNCTION.

ENVIRONMENTAL PROTECTION



Attention!

Your product is marked with this symbol. It indicates that it should not be disposed of with other household waste at the end of its working life. Any used electronic or electric equipment should be separated from the general waste and recycled responsibly according to the act on responsible waste disposal.

Following the implementations of the EU provisions concerning the responsible waste disposal, household users can return all used electronic and electric equipment to the indicated electronic waste collection points free of charge. When purchasing a new product, contact your local government office to receive more information.

If the product has batteries, please remove them as required by law.

A proper disposal of electric and electronic waste promotes the sustainable reuse of material resources and recycling. In this way you prevent possible harm to the environment or human health.

Uncontrolled electric and electronic waste disposal can cause harm to the environment.

Information for business users in EU countries

If the product you want to dispose of was used for business purposes, please contact your dealer to obtain information on the way of its collection, disposal and recycling as well as on possible costs. If you want to dispose of a small unit, it can be returned to the local electronic waste collection point.

Information for business users in non-EU countries

If you want to dispose of the used product, please contact your local government office to obtain information on appropriate form of recycling.



UPUTSTVO ZA UPOTREBU

LED TELEVIZORI Model:43DLE888

Hvala Vam što ste kupili ovaj uređaj.

FOX LED televizori prepoznaju se po odličnim tehničkim karakteristikama, kao i modernom, funkcionalnom i elegantnom dizajnu. Osim toga konstantna unapređenja u vidu postprodajne podrške, izuzetno efikasna i rasprostranjena servisna mreža čine da se ponosni vlasnici **FOX televizora** mogu osećati sigurno.

Napravili ste pravi izbor.

U nastavku slede uputstva za upotrebu. Nisu komplikovana, ali ih se morate pridržavati.



Android™ OS





FOX[®]
be smart

FOX LED televizori
- stvoreni za uživanje.

Hvala Vam što ste kupili ovaj uređaj.

FOX LED televizori prepoznaju se po odličnim tehničkim karakteristikama, kao i modernom, funkcionalnom i elegantnom dizajnu. Osim toga konstantna unapređenja u vidu postprodajne podrške, izuzetno efikasna i rasprostranjena servisna mreža čine da se ponosni vlasnici **FOX televizora** mogu osećati sigurno.

Napravili ste pravi izbor.

U nastavku slede uputstva za upotrebu. Nisu komplikovana, ali ih se morate pridržavati.

SADRŽAJ

Bežbednosne informacije	5
Važne bezbednosne instrukcije	6
Tipke i interfejs	7
Dijagram za povezivanje eksternih uređaja	8
Instalacija i povezivanje TV	9
Pokretanje (Launcher)	10
Početa Stranica	14
Podešavanja	17
Multimedia	21
Izbor izvora signala	24
Meni za sliku	25
Podešavanje Zvuka	28
Podešavanje Kanala	31
Zaključavanje	37
Vreme	38
Dodatna podešavanja	39
Pomoć	41
Specifikacije	42
Daljinski upravljač	43
Zaštita okoline	44

BEZBEDNOSNE INFORMACIJE

OPREZ

**RIZIK OD STRUJNOG
UDARA NE OTVARAJ!**

Ovaj uređaj koristi visoki napon, kako biste sprečili strujni udar nemojete sami otvarati uređaj već se obratite ovlašćenom servisu.

Ukoliko TV ima problema ili bude oštećen nemojete sami započinjati popravku usled opasnosti od strujnog udara već se obratite proizvođaču.



Simbol sa znakom uzvika u jednakostraničnom trouglu upozorava korisnika na prisustvo instrukcija vazanih za korišćenje i održavanje u dokumentaciji koja se isporučuje sa uređajem.

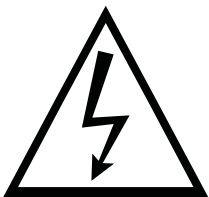

Upozorenje.
Simbol munje u jednakostraničnom trouglu upozorava korisnika na prisustvo opasnog neizolovanog napona unutar proizvoda koji može biti dovoljan za rizik od strujnog udara.

VAŽNE BEZBEDNOSNE INSTRUKCIJE

- 1) Pročitajte ovo uputstvo.
- 2) Zadržite ovo uputstvo.
- 3) Obratite pažnju na sva upozorenja
- 4) Pratite sva uputstva.
- 5) Ne koristite ovaj proizvod u blizini vode.
- 6) Čistite proizvod isključivo suvom krpom.
- 7) Nemojte blokirati ventilacione izlaze na proizvodu. Instalirajte ga u skladu sa proizvođačevim uputstvima.
- 8) Ne postavljajte ovaj proizvod blizu izvora toplote poput radijatora, grejalica, šporeta ili drugih aparata koji emituju toplotu.
- 9) Osigurajte se da je kabl za napajanje postavljen tako da se po njemu ne hoda i da nije zamršen ili previše utegnut kod utikača i na mestu gde izlazi iz proizvoda.
- 10) Isključivo koristite dodatke naznačene od strane proizvođača.
- 11) Proizvod koristite isključivo na stočiću, stativu ili stolu koji je naznačen od strane proizvođača ili se prodaje uz proizvod. Prilikom premeštanja postolja, budite oprezni kako se ne bi povredili.



- 12) Isključite aparat iz struje tokom oluja ili kada ga ne koristite duži vremenski period.
Oprez:
 - 13) Kako biste smanjili rizik od požara ili strujnog udara, nemojte izlagati ovaj aparat kiši ili vlagi.
 - 14) Glavni priključak se koristi kao uređaj za isključivanje; ovaj deo uvek mora uvek biti spreman za korišćenje.
 - 15) Utičnica mora da se nalazi blizu proizvoda i mora biti lako dostupna.
 - 16) Proizvod ne treba postaviti u ugradni plakar, kao i police za knjige ili vitrine, osim ako je odgovarajuća ventilacija obezbeđena ili su uputstva proizvođača detaljno praćena.
 - 17) Aparat ne sme biti izložen kapljanju ili prskanju; na njega ne treba postavljati nikakve stvari ispunjene tečnošću, poput vaza.
 - 18) Ne postavljajte bilo kakve izvore opasnosti na aparat, kao na primer: predmete ispunjene tečnošću, upaljene sveće itd.
 - 19) Montaža na zidu • aparat bi trebalo montirati na zid samo po preporuci proizvođača.
- 20)  (l) Nikada nemojte postavljati TV, daljinski upravljač ili baterije u blizini plamena, ali ni na direktnu sunčevu svetlost. Sprečite širenje vatre, držite sveće i druge izvore plamena dalje od televizora, daljinskog upravljača i baterija.
- 21) USB terminal bi trebalo da bude napunjen sa 0.5A pri normalnom radu.
Ova uputstva za servisiranje se koriste samo od strane kvalifikovanog osoblja servisa. Kako bi smanjili opasnost od strujnog udara, ne vršite servisiranje sami po uputstvu, osim ako ste kvalifikovani za to.
- 22) Baterija ne sme biti izložena prekomernoj temperaturi, kao što je ona što potiče od sunca, vatre ili sličnog.
- 23) Ova oprema je Klasa 11 ili duplo izolirana električna naprava. Dizajnirana je na takav način da ne zahteva bezbedonosnu konekciju sa uzemljenjem
- 24) Maksimalna temperatura okoline je 45 stepeni. Maksimalna visina na kojoj uređaj može da se nalazi je 2000 metara.

TV TASTERI I INTERFEJS

TV TASTERI

Napomena: Ključna uputstva su u nastavku.

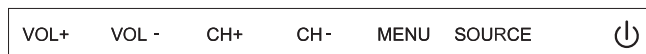

Displej\Sakrij taster ikone: Kada se ikonica ne pojavljuje, pritisnite taster, ikonica će se pojaviti kao slika prikazane gore, automatski se isključuje nakon 5 sekundi ne aktivnosti.
Izbor ikona: Kratko pritisnite taster, pomerite udesno i izaberite ikonice.
Odabir funkcija selekcije: Pritisnite i zadržite taster kako bi se funkcija ikonice ostvarila. Opis ikona:

Isključeno ikona: Odgovara "POWER" tasteru na daljinskom.

Meni ikona: Odgovara "MENU" tasteru na daljinskom.

Vodič ikona: Odgovara "SOURCE" tasteru na daljinskom.

CH+ ikona: Odgovara "CH+" tasteru na daljinskom.











CH- ikona: Odgovara "CH-" tasteru na daljinskom.

Pojačaj+ ikona: Odgovara "VOL+" tasteru na daljinskom.

Smanji - ikona: Odgovara "VOL-" tasteru na daljinskom.

Priključci

Napomena: položaj i tip intefejsa su različiti za različite modele televizora.

	AV input External AV Signal Input and Relevant Right/Left Sound Channel		PC AUDIO INPUT VGA input and audio input when VGA input
	Y Pb Pr input Connect to the composite terminal of your DVD NCR (Some models without this interface)		EARPHONE output When earphones are plugged in, speakers are disabled
	HDMI input Digital signal input from HDMI video connector.		USB input Connect a USB device here to play its media files or to record programs via the PVR function.
	ANT75 Connect the antenna/cable tv input (75NHf/UHF)		COAXIAL Connect the SPDIF receiver.
	VGA input PC analog signal input		RJ45 Connect the Internet.

DIJAGRAM ZA POVEZIVANJE EKSTERNIH UREĐAJA

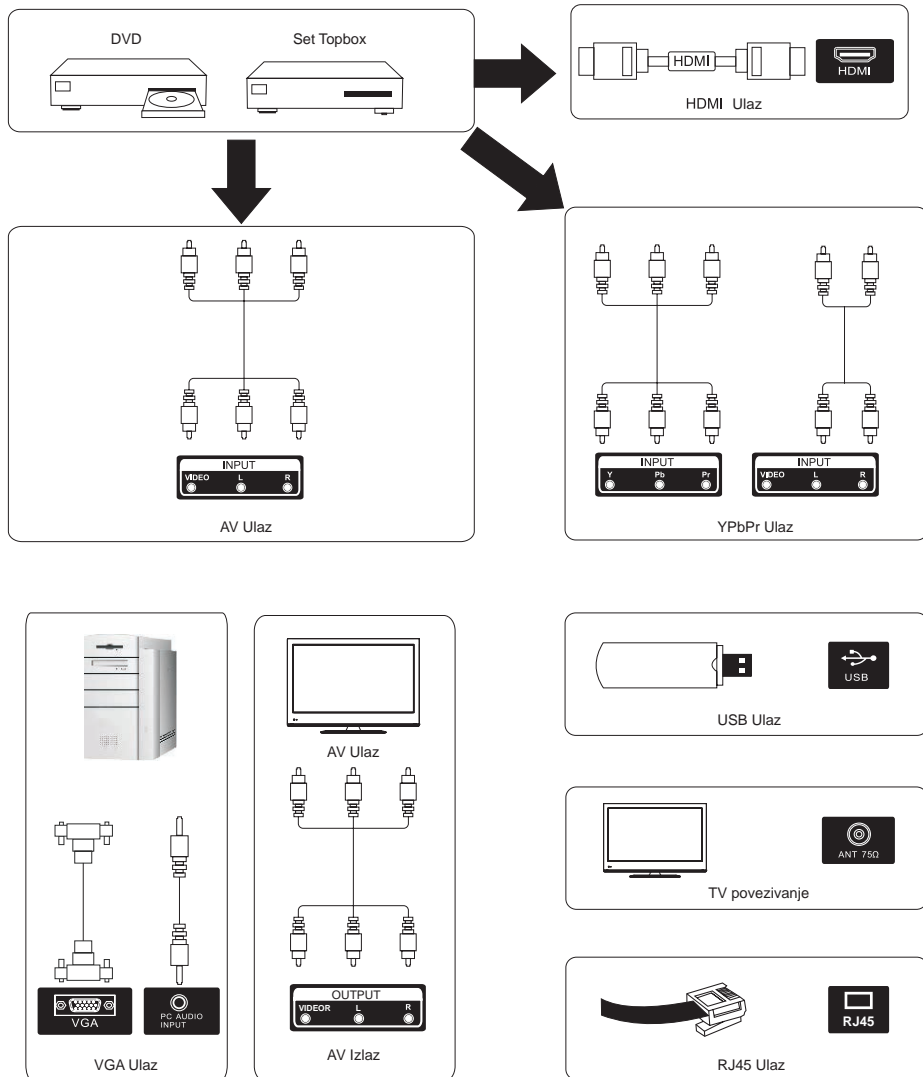

NAPOMENA

UKOLIKO PROGRAM PRATITE PUTEM KABLOVSKE TELEVIZIJE PROVERITE DA LI JE PROPISNO IZVEDENO UZEMLJENJE I IZJEDNAČAVANJE POTENCIJALA NA KABLU VAŠEG KABLOVSKOG OPERATERA. ZA OVE INFORMACIJE KONTAKTIRAJTE VAŠEG KABLOVSKOG OPERATERA

INSTALACIJA I POVEZIVANJE TELEVIZORA

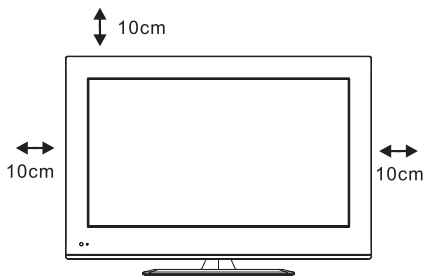

Postavite svoj TV

Postavite svoj televizor na čvrsto mesto koje može da izdrži njegovu težinu. Kako biste izbegli opasnost, nemojte postavljati televizor blizu vode ili izvora toplote (kao što su svetlo, sveće, grejači); Nemojte blokirati ventilaciju na poleđini televizora.

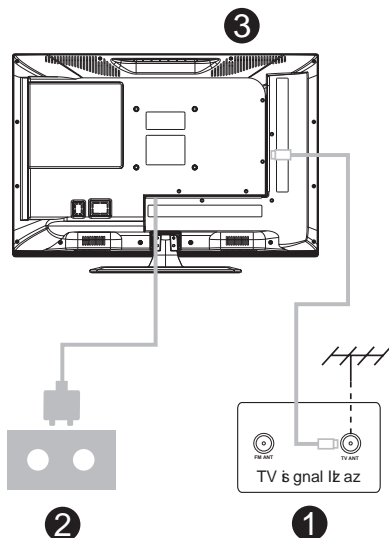

Povežite antenu i struju

1. Povežite kabal antene sa ulazom za antenu na poleđini televizora.
2. Uključite strujni kabal TV u struju (AC100-240V~50/60Hz).

Uključite TV

3. Pritisnite dugme za uključivanje TVa, indikaciono svetlo će se pretvoriti u zeleno. Ako je TV na standby modu (svetlo je crveno), pritisnite dugme za uključivanje na daljinskom upravljaču kako biste uključili televizor.

Beleška:

Slika služi isključivo za pojašnjenje.

INSTALACIJA POSTOLJA TELEVIZORA

1. Otvorite kutiju i izvadite televizor iz nje, kao i raštrkane dodatke i postolje, bazu (neki modeli je nemaju)
2. Kako ne biste naneli štetu televizoru, prekrijte ga nečim mekanim, postavite na sto, ekran prekriven mekanim okrenut ka dole, postolje je šrafovim povezano sa TVom.
3. Ušrafite bazu.
4. Instalacija je završena.

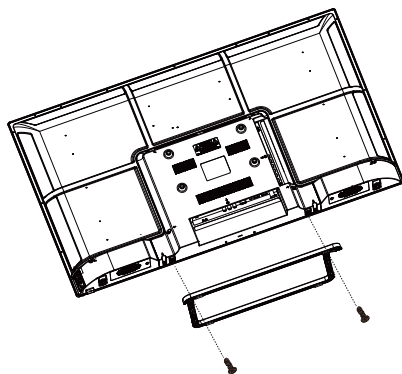

Beleška: Slika služi isključivo za pojašnjenje

POKRETANJE (LAUNCHER)

Povežite RF kabl od TV ulaza zvanog "RF-In" do vaše TV Aerial utičnice. Pritisnite **ENTER** taster da biste izabrali Start the setup (početak podešavanja).

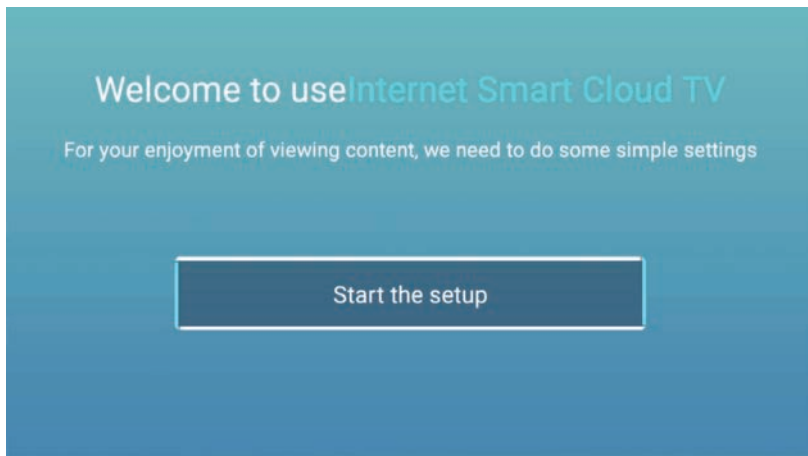

Pritisnite **▲ / ▼** taster kako biste izabrali jezik.
Pritisnite **OK** taster a potom pritisnite **▶** taster kako biste izabrali zemlju.



POKRETANJE (LAUNCHER)

Pritisnite ▲ / ▼ taster kako biste izabrali zemlju.

Pritisnite **OK** taster a potom pritisnite ► taster kako biste izabrali vremensku



Pritisnite ▲ / ▼ kako biste izabrali vremensku zonu. Pritisnite ► taster kako biste se povezali na WIFI / network.

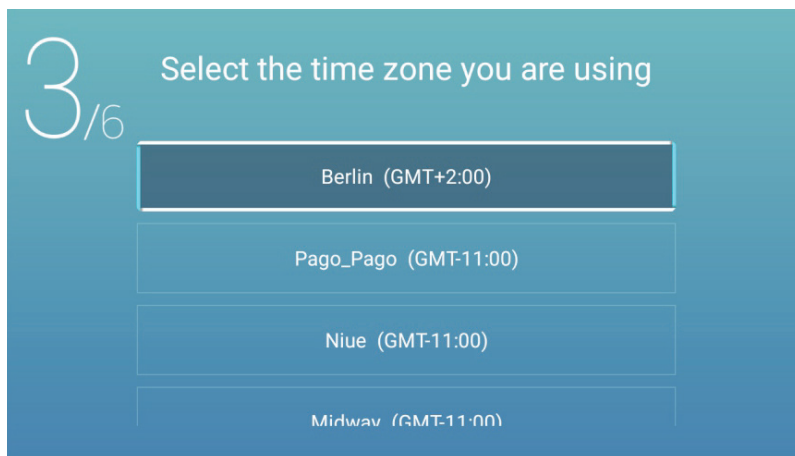

POKRETANJE (LAUNCHER)

Pritisnite **OK** taster kako biste se povezali na WIFI / network. Pritisnite ► taster kako biste se povezali sa TV Assistant.

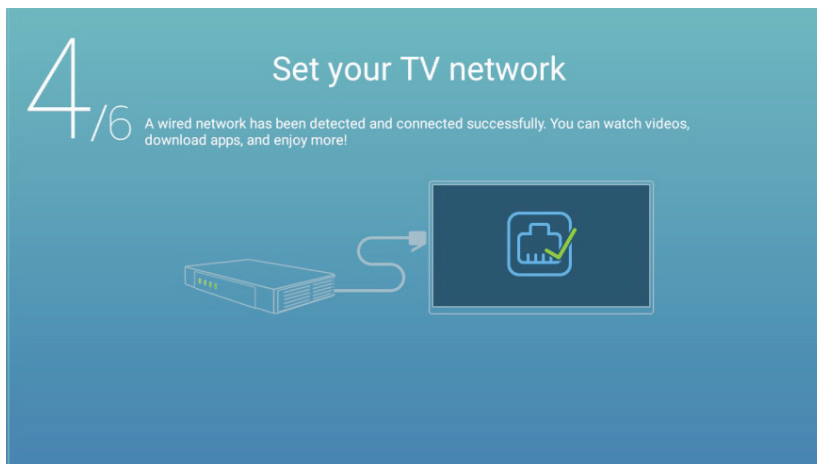

Koristite svoj mobilni telefon da skenirate 2D kod kako biste se povezali na TV Asslstant. (Pogledajte Eshare dokumenta za detalje)
Pritisnite ► taster za izbor signala.

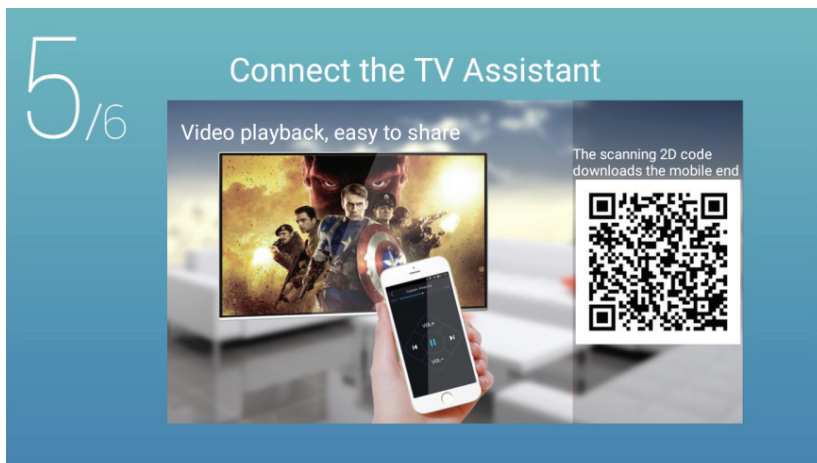

POKRETANJE (LAUNCHER)

Pritisnite ▲ / ▼ taster za izbor signala.

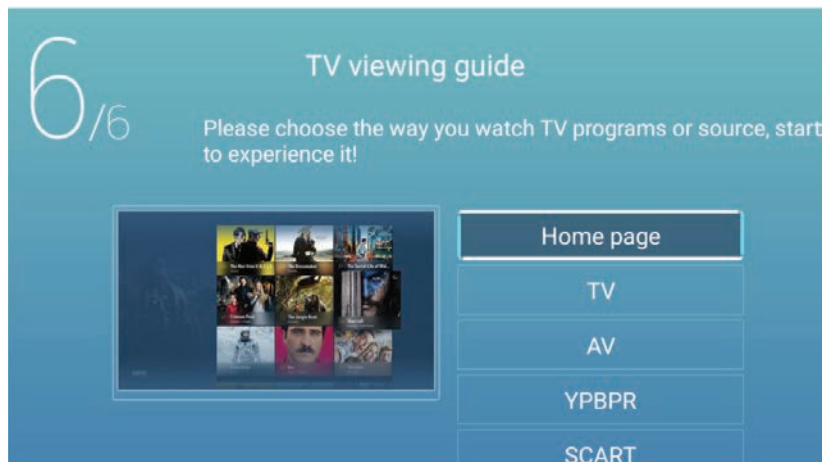

POČETNA STRANICA

POČETNA STRANICA

Pritisnite ◀ / ▶ taster i izaberite **HOME** u glavnom meniju. Pritisnite ▲ / ▼ taster kako biste izabrali

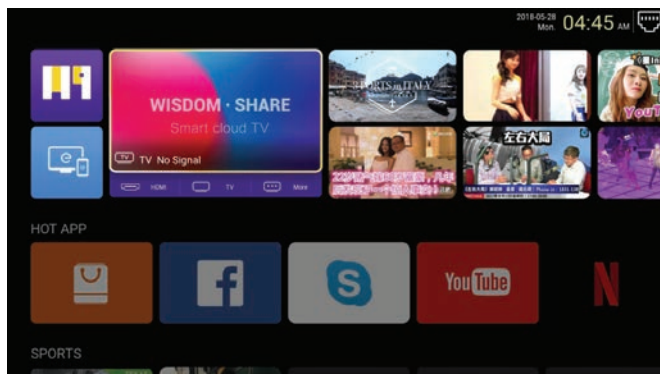

HOT APP

Pritisnite ▲ / ▼ / ◀ / ▶ taster kako biste izabrali **App Store** pod **HOT APP** da biste dodali aplikaciju.

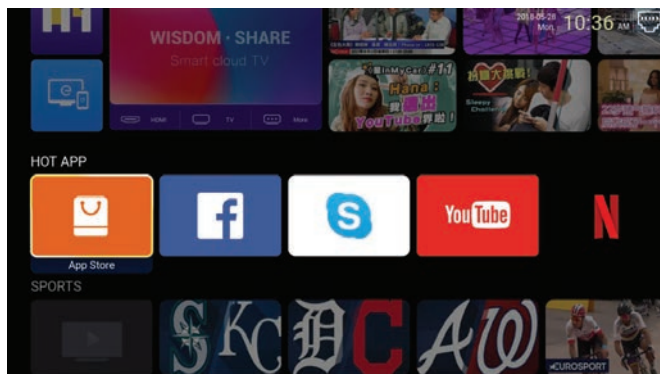

POČETNA STRANICA

Pritisnite ▲ / ▼ / ◀ / ▶ kako biste izabrali **Apps** i pritisnite **ENTER** kako biste dodali aplikaciju.

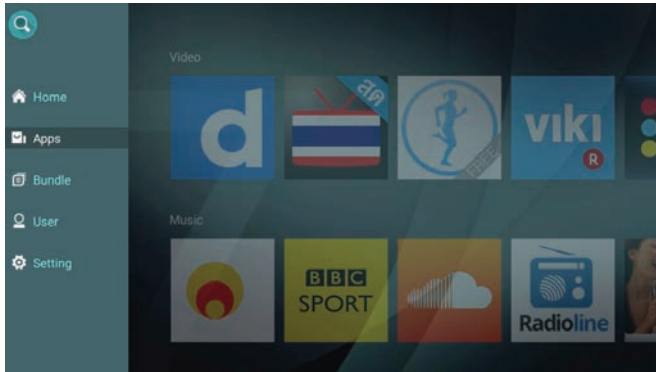

POČETNA STRANICA

FAV APP

Pritisnite ▲ / ▼ kako biste izabrali **FAV APP** kako biste dodali omiljene aplikacije.

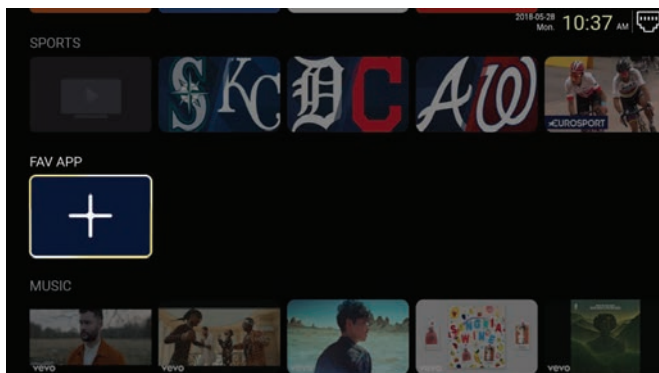

Pritisnite ▲ / ▼ / ◀ / ▶ kako biste izabrali omiljene aplikacije pa pritisnite **ENTER** kako biste dodali aplikaciju.

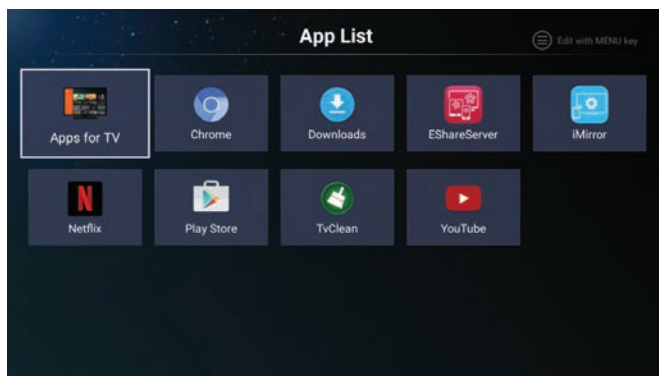

E-Share Server

E-SHARE je funkcija koja omogućava povezivanje Android telefona ili iPhonea sa televizorom i omogućava prikaz sadržaja mobilnog telefona na TV ekranu bežičnim putem. Koristeći daljinski upravljač pronađite E-Share na ekranu. Primetićete 2D kod, potom ga skenirajte, sada možete koristiti E-Share funkciju.

iMirror

Pomoću ove aplikacije možete prenositi sadržaj sa kompjutera na TV putem interneta.

PODEŠAVANJA

PODEŠAVANJA

Pritisnite ▲ / ▼ / ◀ / ▶ taster kako biste ušli u podešavanja.

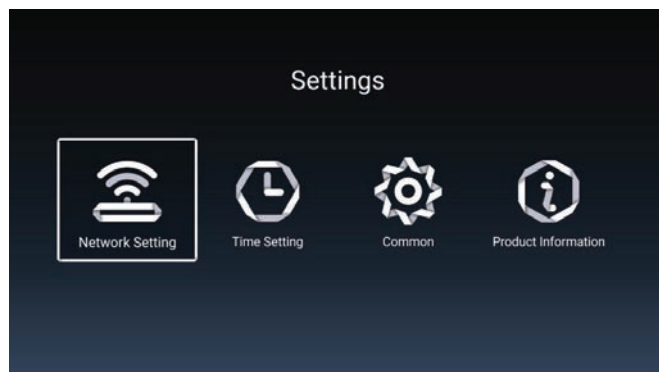
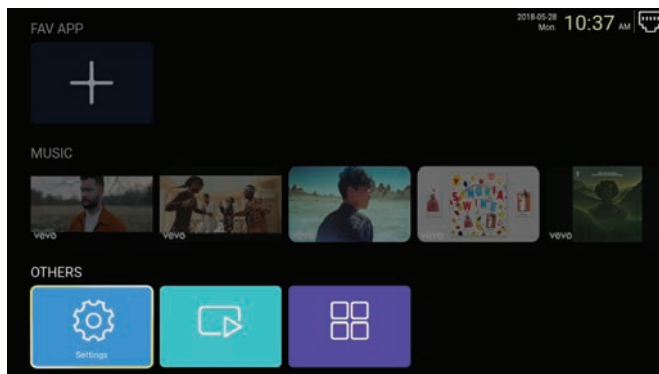

PODEŠAVANJA

Mrežna podešavanja

Pritisnite ▲ / ▼ / ◀ / ▶ taster kako biste podesili mrežu.

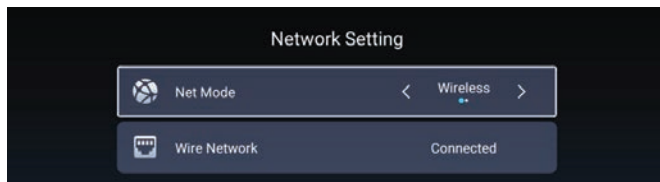

Podešavanje Vremena

Pritisnite ◀ / ▶ taster kako biste izabrali ON/OFF.

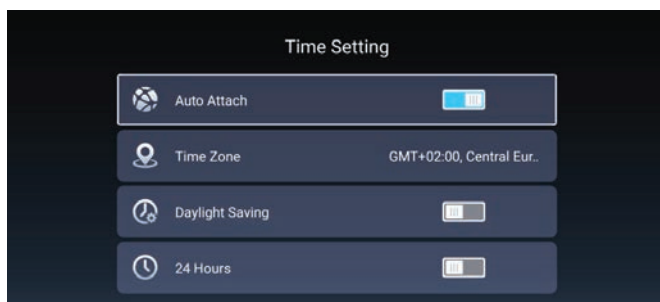

Common

Pritisnite ▲ / ▼ kako biste podesili ovu opciju.

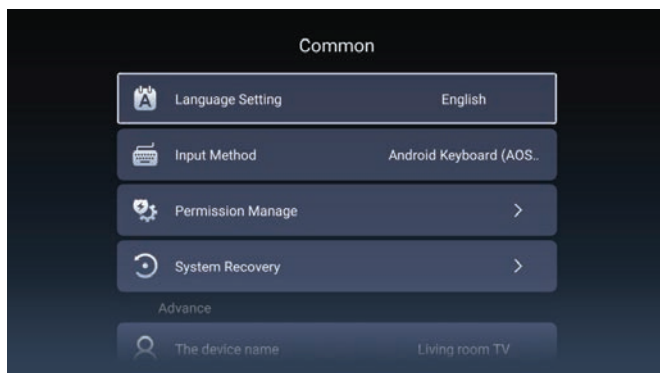

PODEŠAVANJA

Podešavanje pristupa

Pritisnite ► kako bi pristupili i podesili aplikaciju za pristup.

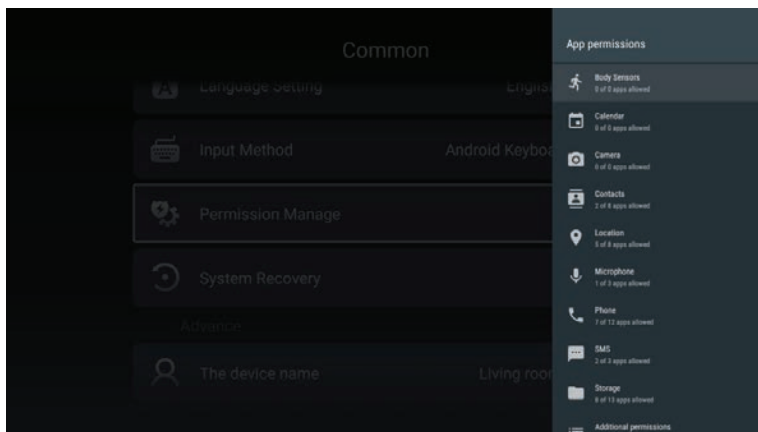

Povrat Sistema u pređašnje stanje

Pritisnite ► da biste pristupili i povratili sistem u pređašnje stanje.

PODEŠAVANJA

Informacije o proizvodu

Pristupi Product Information kako biste videli detaljne informacije.

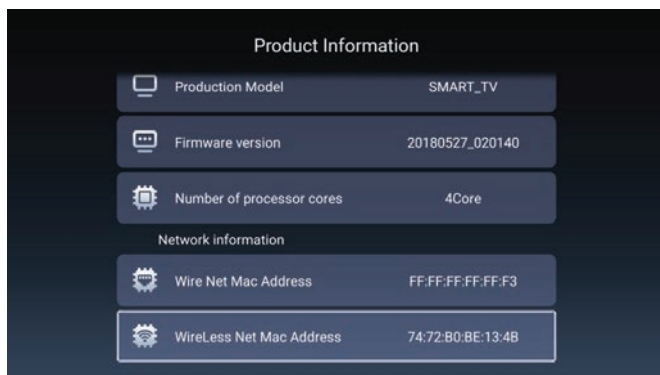
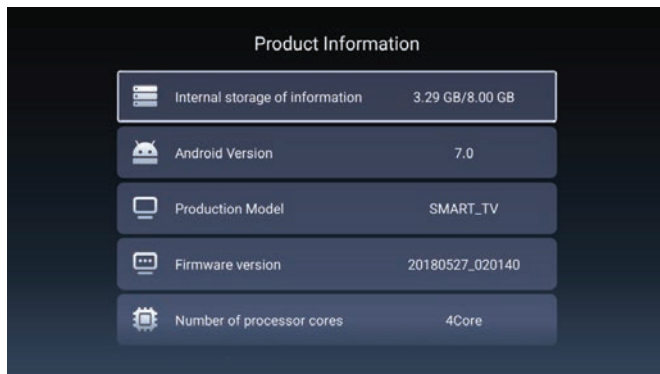

MULTIMEDIA

Multimedija

Pritisnite ▲ / ▼ / ◀ / ▶ kako biste izabrali **Multimedia** na Home stranici zatim pritisnite **ENTER** Kako biste izabrali.

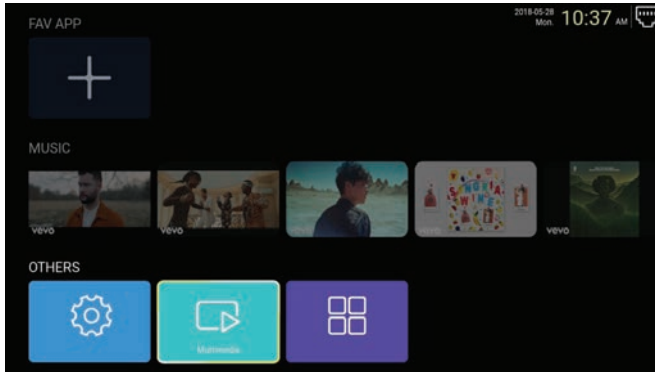

Video

Pritisnite ◀ / ▶ da izaberete vdeo.



Pritisnite kako biste pustili prethodni video.



Pritisnite kako biste pustili brzo premotavanje unazad.



Pritisnite stop/play za film.



Pritisnite kako biste pustili brzo premotavanje unapred.



Pritisnite kako biste pustili sledeći video.

MULTIMEDIA



Pritisnite kako biste videli informacije o filmu. (Rezolucija/Dužina/Trajanje/Bittrate)



Pritisnite Audio Track/Select Subtitle/Region Language/Play Mode/Aspect Ratio.



Pritisnite kako biste pustili film.

Slike

Pritisnite ◀ / ▶ kako biste izabrali sliku.



Pritisnite kako biste rotirali sliku u pravcu suprotnom od kazaljke na satu.



Pritisnite kako biste stopirali/pokrenuli sliku.



Pritisnite kako biste rotirali sliku u pravcu kazaljke na satu.



Pritisnite kako biste videli informacije vezane za sliku. (Size/Resolution)



Pritisnite kako biste podesili Play Mode (Aspect Ratio/Playback duration).



Pritisnite kako biste izabrali sliku koju ste želeli da pustite.

MULTIMEDIA

Muzika

Pritisnite ▲ / ▼ kako biste izabrali muziku.



Pritisnite kako biste brzo premotali unazad.



Pritisnite kako biste stopirali/pustili muziku.



Pritisnite kako biste brzo premotali unapred.



Pritisnite kako biste videli informacije u muzici. (Mine Type/Size/Bitrate).



Pritisnite kako biste podesili Play Mode (Repeat All/Repeat One/Random/None).



Pritisnite kako biste izabrali muziku.

IZVOR

Izvor signala

Pritisnite ◀ / ▶ taster kako biste izabrali **Source** u glavnom meniju.

Pritisnite ▲ / ▼ taster kako biste izvršili odabir.

Pritisnite **ENTER** kako biste izabrali izvor.

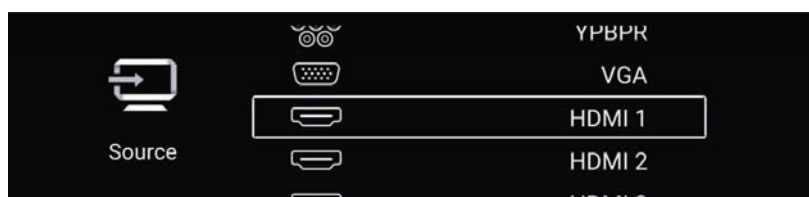
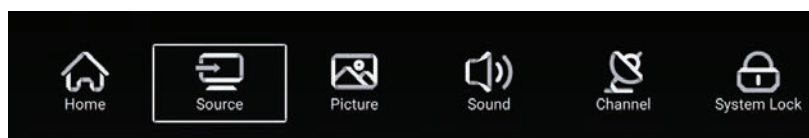

SLIKA

Podešavanje slike

Pritisnite ◀ / ▶ taster kako biste izabrali **Picture**. Pritisnite **ENTER** kako biste ušli u podešavanja

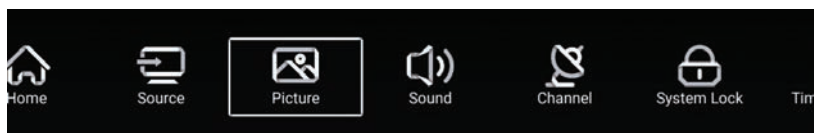

1. Pritisnite ▲ / ▼ kako biste izabrali: Picture Mode/Contrast/Brightness/Color Sharpness/Backlight/Noise Reduction/ Aspect Ratio/Color Temp/More Settings
2. Pritisnite ◀ / ▶ kako biste podesili ili izabrali.

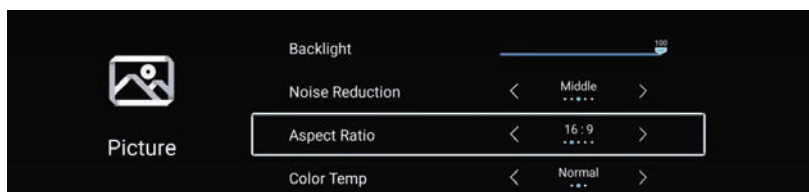
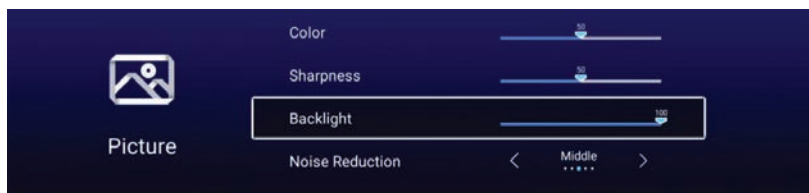
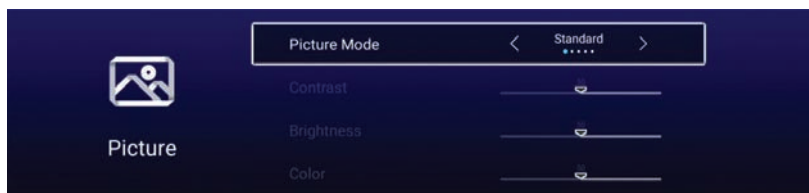

Mod za slike

Pritisnite ▲ / ▼ taster kako biste izabrali Picture Mode, zatim pritisnite ◀ / ▶ kako biste izabrali (Opcije: Standard, Movie, Vivid, Energy Saving, User).

Standard	Glavni mod, kako bi korisnici imali jako kvalitetnu sliku pod normalnim svetlom.
Movie	Ovaj mod je više prigodan za gledanje filmova.
Vivid	Slike boja su lepše, slike su živopisnije.
Energy Savlng	Smanjuje jačinu osvetljenja kako bi sačuvao energiju i potrošnju.
User	Korisnik sam podešava sliku po potrebi..

Contrast/ Brightness/Colour/Sharpness/Backlight

Pritisnite ▲ / ▼ kako biste izabrali ◀ / ▶ za podešavanje

Contrast	Podesite kontrast na slici.
Brightness	Podesite svetlost na slici.
Color	Podesite gustinu boje.
Sharpnass	Podesite oštrinu slike.
Backlight	Podesite pozadinsko svetlo na ekranu.

Smanjite Buku

Podešavanje opcije za eliminisanje intenziteta buke.

Pritisnite ▲ / ▼ da izaberete Noise Reduction, potom pritisnite ◀ / ▶ kako biste izabrali. (Opcije: Off, Low, Medium, High, Auto).

Aspect Ratio

Podesite veličinu displeja.

Pritisnite ▲ / ▼ kako biste izabrali Aspect Ratio, zatim pritisnite ◀ / ▶ kako biste izabrali (Opcije: Auto/16:9/4:3/zoom1/zoom2/)

Napomena: Ova opcija je raspoloživa samo kada ima signal za TV.

Color Temp

Podesite boju slike po želji.

Pritisnite ▲ / ▼ da biste izabrali ColourTemperature. Pritisnite ◀ / ▶ kako biste izabrali (Opcije:Cool,Normal,Warm).

Cool	Pravi slike nežno plave boje.
Normal	Pravi živopisne slike.
Warm	Pravi slike crvenkaste boje.

SLIKA

Dodatna podešavanja

Pritisnite ▲ / ▼ kako biste izabrali More Settings.

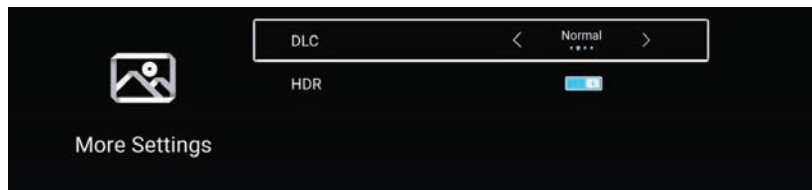

DLC

Pritisnite ▲ / ▼ kako biste izabrali DLC, pa pritisnite ◀ / ▶ kako biste izabrali Dark/Normal/Bright/Off.

HDR

Pritisnite ◀ / ▶ kako bi izabrali ON/OFF.

ZVUK

Zvuk

Pritisnite MENU bi pristupili glavnom meniju. Pritisnite ◀ / ▶ kako biste izabrali Sound u glavnom meniju.

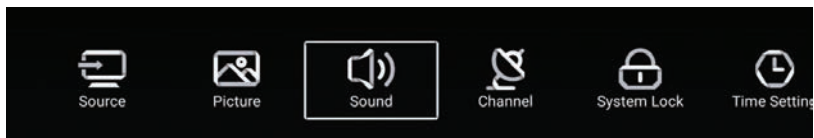

Pritisnite ▲ / ▼ da izaberete: Sound Mode/Bass/Treble/Balance/AVC/Audio Description/ Hearing Impaired/More settings.

Pritisnite ENTER/◀ / ▶ da izvršite podešavanja.

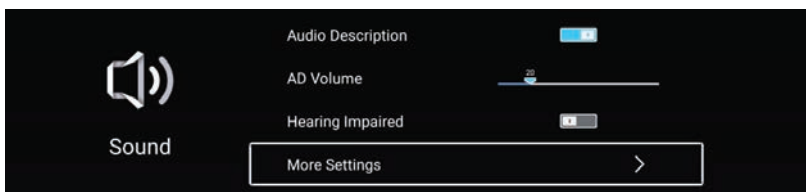
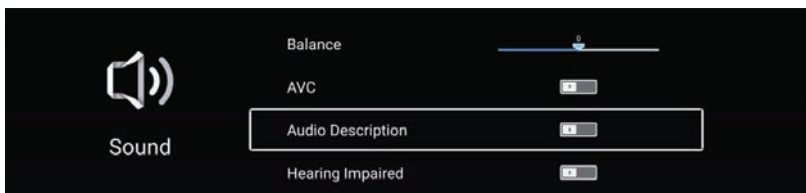
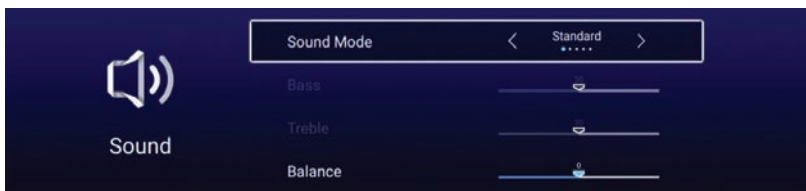

ZVUK

Sound Mode

Pritisnite ▲ / ▼ taster kako biste izabrali Sound Mode, potom pritisnite ◀ / ▶ taster kako biste izabrali. (Opcije: Standard, Music, Theater, News, User).

Standard	Reprodukuje balansiran zvuk u svim uslovima.
Music	Zadržava originalni zvuk pogodan za muzičke programe.
Theater	Pojačava treble i bas za bogato zvučno iskustvo.
News	Pojačan glas za slušanje vesti.
User	Izabereti kako biste sami prilagodili zvuk.

Bas	Prilagodite bas.
Treble	Podesite trebl.
Balance	Podesite levi I desni kanal balansa.

Pritisnite ▲ / ▼ taster kako biste izabrali Balance, pa pritisnite ◀ / ▶ taster kako biste izvršili podešavanja.

AVC

Pritisnite ▲ / ▼ taster kako biste izabrali AVC, zatim pritisnite ◀ / ▶ taster kako biste izabrali ON/OFF. Posle otvaranja AVC, kada je vreme podešeno i bez obzira na različite TV verzije štampane na svakom kanalu, može da održava jačinu zvučnika stabilnom

Audio opis

Pritisnite ◀ / ▶ taster za ON/OFF. Ako je podešeno ON, pritisnite ◀ / ▶ da podesite AD Volume.

Podešavanja za osobe oštećenog sluha

Pritisnite ◀ / ▶ taster kako biste podesili ON/OFF.

Napomena: Audio Opis i Podešavanja za osobe sa oštećenim sluhom je moguće samo ako je prisutan TV signal.

ZVUK

Dodatna podešavanja

Pritisnite ▲ / ▼ taster kako biste izabrali More Settings, zatim pritisnite ► taster kako biste ga izabrali.

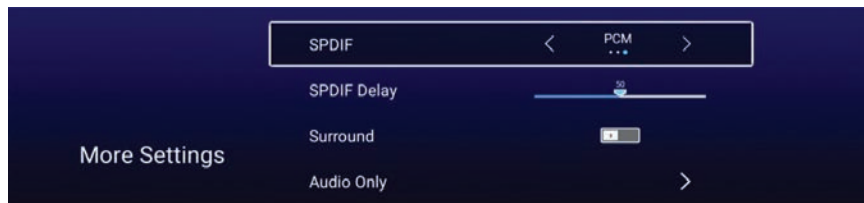

SPDIF

Pritisnite ▲ / ▼ taster kako biste izabrali SPDIF, zatim pritisnite ◀ / ▶ taster kako biste izabrali OFF/RAW/PCM.

SPDIF Delay

Pritisnite ▲ / ▼ taster kao biste izabrali SPDIF Delay, zatim pritisnite ◀ / ▶ taster kako biste izvršili podešavanja.

Surround

Služi za postizanje boljeg efekta zvuka.

Pritisnite ▲ / ▼ taster kako biste izabrali Surround, zatim pritisnite ◀ / ▶ taster kako biste izabrali ON/OFF.

Audio Only

Ova opcija omogućuje puštanje zvuka bez aktiviranja ekrana.

Pritisnite ▲ / ▼ taster kako biste izabrali Audio Only, zatim pritisnite ◀ / ▶ taster kako biste izabrali ON/OFF

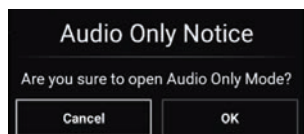

KANALI

Kanali

Pritisnite **MENU** taster kako biste izabrali glavni meni. Pritisnite **◀ / ▶** taster kako biste izabrali Channel u glavnom meniju.

Pritisnite **▲ / ▼** kako biste izabrali, zatim pritisnite **ENTER / ▶ / ▶** kako biste ušli.

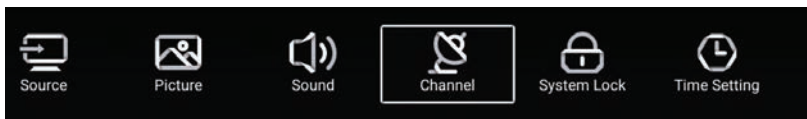

Antenna Type-Air

Izaberite Air/Cable/Satellite kako biste izvršili podešavanja.

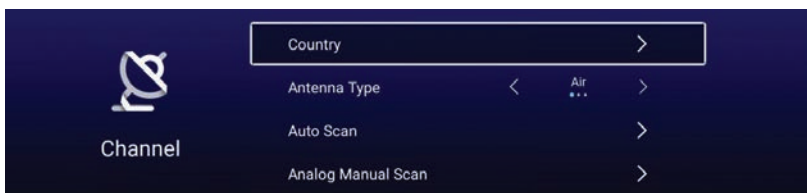

Country

Pritisnite **▶** kako biste podesili državu koju želite.

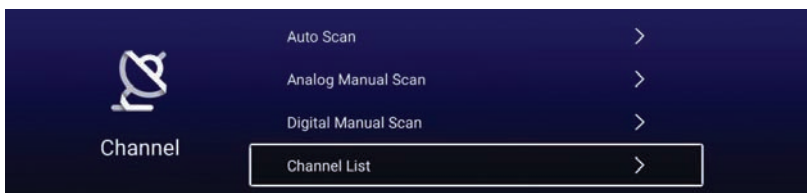

Auto Scan

Pritisnite **▲ / ▼** taster kako biste izabrali Auto Scan, zatim pritisnite **ENTER** kako biste započeli Auto Scan.

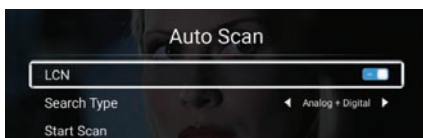

KANALI

Analog Manual Scan

Pritisnite ▲ / ▼ taster kako biste izabrali Analog Manual Scan, pritisnite **ENTER** da biste započeli skeniranje.

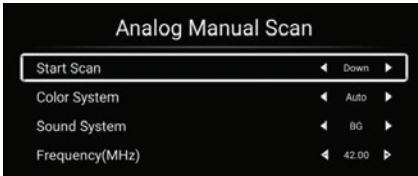

Digital Manual Scan

Pritisnite ▲ / ▼ taster kako biste izabrali Digital Manual Scan, pritisnite **ENTER** da biste započeli skeniranje.

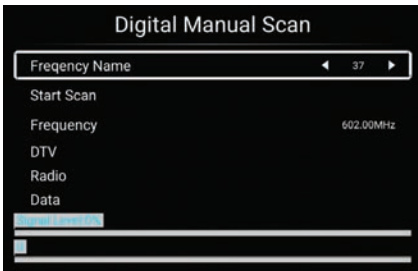

Channel List

Pritisnite ▲ / ▼ taster kako biste započeli Channel List, kada izlista, pritisnite **MENU** dugme i uredite kanal (Skip /Delete /Fav)

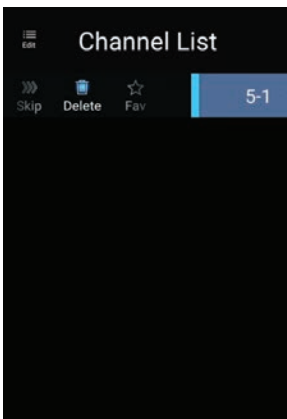



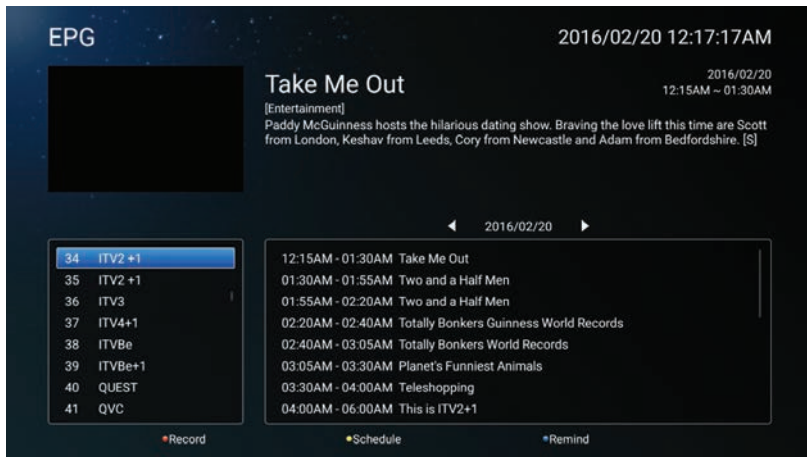

KANALI

EPG

Pritisnite ▲ / ▼ taster kako biste izabrali EPG.



-  **Record** - Podesite vreme i kanal kako biste autmoatski snimili sadržaj
-  **Schedule** - Pogledajte raspored spremljen za snimanje.
-  **Remind** - Podesite vreme kada ćete biti obavešteni o rasporedu snimanja.
-  Pritisnite taster na vašem daljinskom upravljaču kako biste momentalno snimili program
-  Pritisnite taster na vašem daljinskom upravljaču kako biste zaustavili snimanje.

Antenna Type-Cable

Izaberite Air/Cable/Satellite za podešavanje.

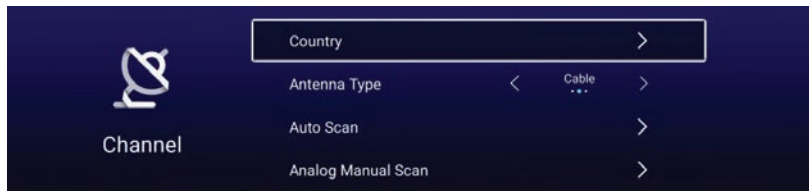

Country

Pritisnite ► kako biste izabrali podešavanje za odabir države

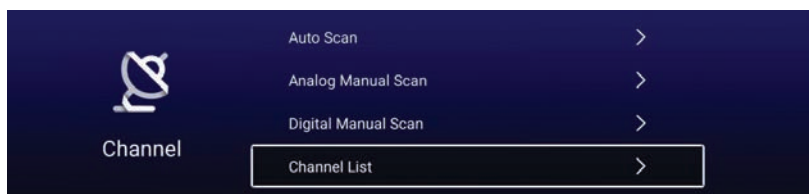

KANALI

Auto Scan

Pritisnite **▲ / ▼** taster kako biste izabrali Auto Scan, zatim pritisnite **ENTER** kako biste započeli autoskeniranje.

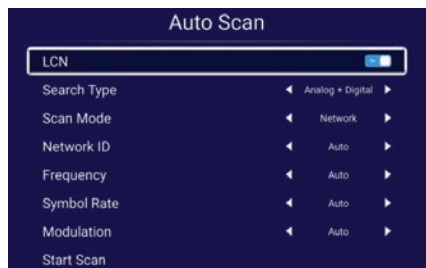

Analog Manual Scan

Pritisnite **▲ / ▼** taster kako biste izabrali Analog Manual Scan, zatim pritisnite **ENTER** kako biste započeli skeniranje.

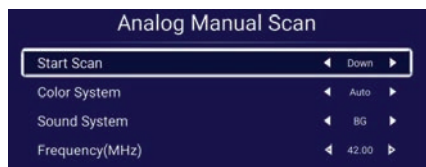

Digital Manual Scan

Pritisnite **▲ / ▼** taster kako biste izabrali Digital Manual Scan, pritisnite **ENTER** kako biste započeli skeniranje.

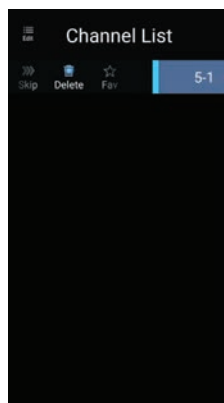
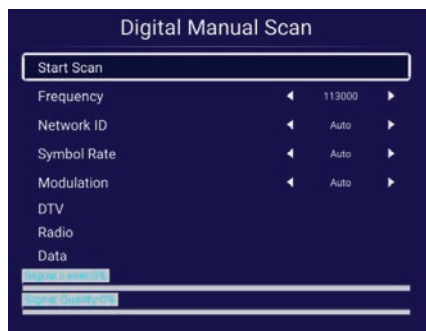

Channel List

Pritisnite **▲ / ▼** taster kako biste izabrali Channel List, pritisnite **MENU** taster kako biste uredili (Skip /Delete /Fav).

KANALI

Antenna Type-Satellite

Izaberite Air/Cable/Satellite kako biste izvršili podešavanje..

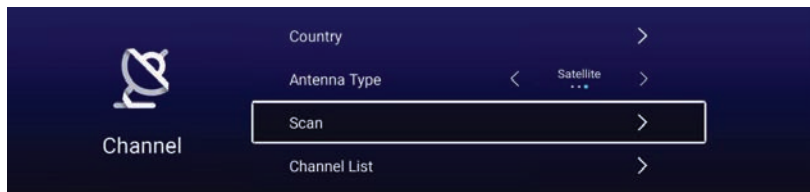

Country

Pritisnite ► kako biste izvršili podešavanja za izbor države.

Scan

Pritisnite ▲ / ▼ taster kako biste izabrali Scan.

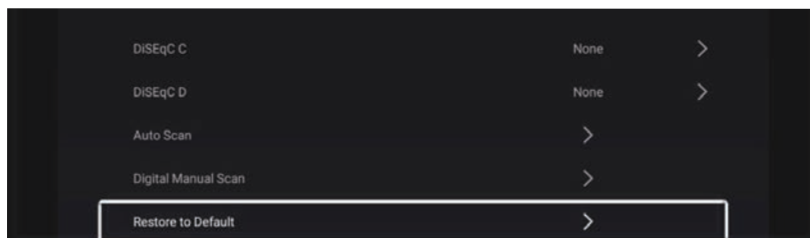
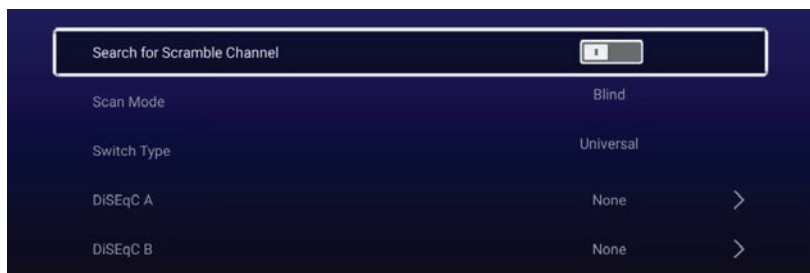

KANALI

Auto Scan

Pritisnite ▲ / ▼ taster kako biste izabrali Auto Scan.

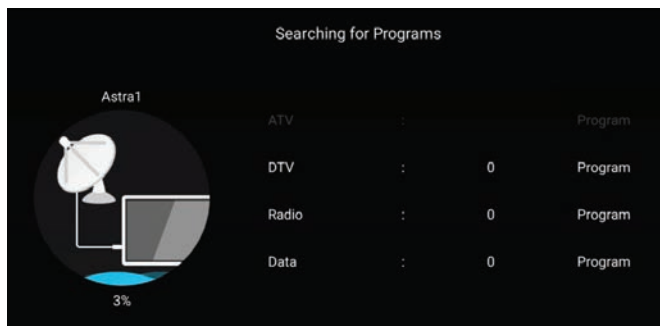

Digital Manual Scan

Pritisnite ▲ / ▼ taster kako biste izabrali Digital Manual Scan kako biste našli program koji ste izabrali.

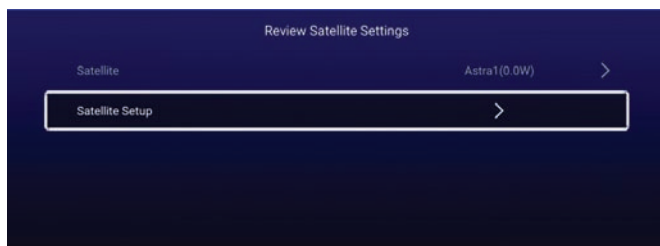

Restore to Default (Vratite na početno stanje)

Pritisnite ▲ / ▼ kako biste izabrali Restore to Default da utvrdite da li želite da obrišete izabrane kanale.

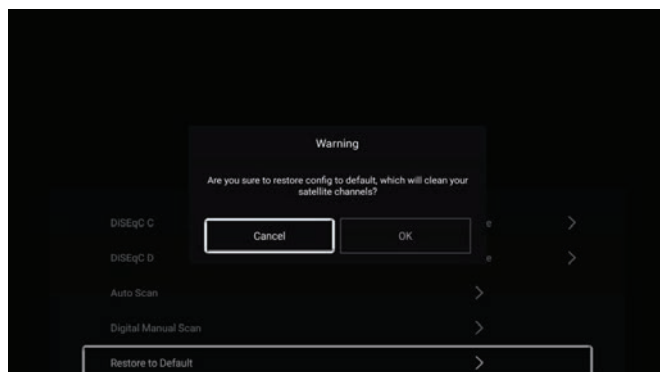

ZAKLJUČAVANJE

Zaključavanje sistema

Pritisnite MENU taster kako biste ušli u glavni meni. Pritisnite ◀ / ▶ taster kako biste izabrali System Lock

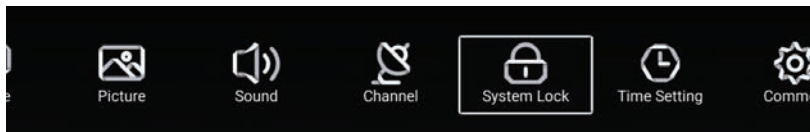

Pritisnite ▲ / ▼ taster kako biste izabrali Change Password/System Lock. Pritisnite ENTER / ◀ / ▶ kako biste ušli u podešavanja.

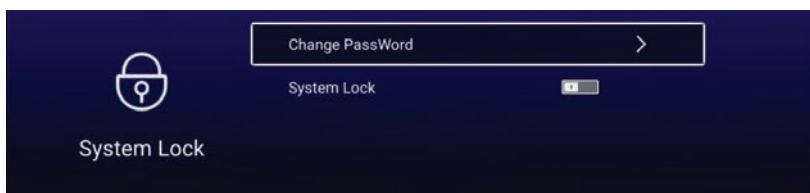

Promena lozinke

Pritisnite ▲ / ▼ taster kako biste izabrali Change Password.

Zaključavanje sistema

Pritisnite ▲ / ▼ taster kako biste izabrali System Lock.

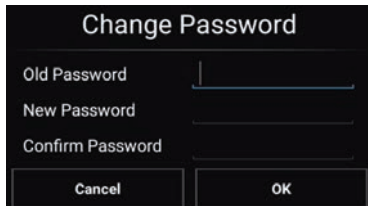

Roditeljska kontrola

Neki programi nisu prikladni za decu, kroz Parental Control podešavanja, roditelji mogu da zabrane neprikladan sadržaj automatski. Pritisnite ▲ / ▼ taster Parental Control. Pritisnite ▲ / ▼ taster kako biste izabrali Off /4 /5 /6/ 7 ...18 (Godine starosti). Ova funkcija je moguća samo ako postoji signal TV.

Zaključavanje tastature

Pritisnite ▲ / ▼ taster kako biste zaključali tastaturu.

Napomena: Ova funkcija je moguća samo ako je System Lock uključen.

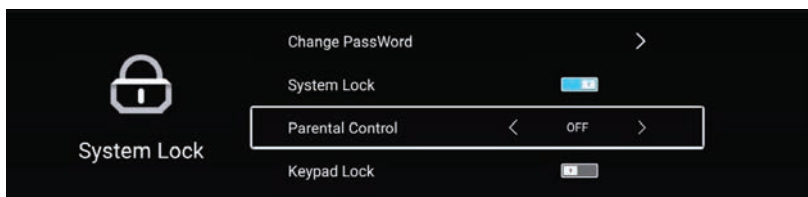

PODEŠAVANJE VREMENA

Podešavanje vremena

Pritisnite MENU taster kako biste ušli u glavni meni. Pritisnite ◀ / ▶ taster kako biste izabrali Time Setting u glavnim meniju.

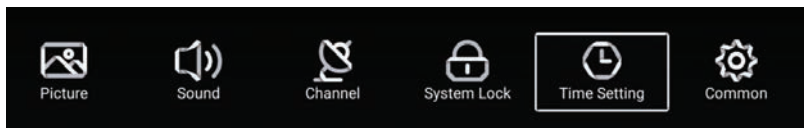

Pritisnite ▲ / ▼ taster kako biste izabrali : OSD Timer/Sleep Timer/Autostandby Timer. Pritisnite ENTER/ ◀ / ▶ kako biste ušli.



OSD Timer

Pritisnite ▲ / ▼ taster kako biste izabrali OSD Timer, Press ◀ / ▶ kako biste izabrali (Opcije: off, 5sec, 15sec, 30sec).

Sleep Timer

Pritisnite ▲ / ▼ taster kako biste izabrali Sleep Timer, Pritisnite ◀ / ▶ kako biste izabrali (Opcije: off, 15min, 30min, 45min, 60min, 90min, 120min, 240min).

Autostandby Timer

Pritisnite ▲ / ▼ taster kako biste izabrali Autostandby Timer, (Opcije: off, 3hour, 4hour, 5hour)

DODATNA PODEŠAVANJA

Common

Pritisnite MENU taster kako biste izabrali glavni meni. Pritisnite ◀ / ▶ taster da izaberete Common u glavnom meniju.

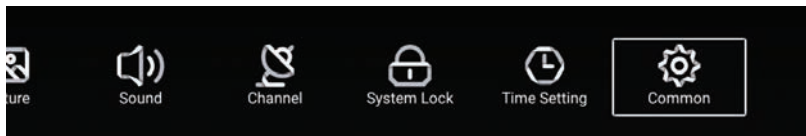

Pritisnite ▲ / ▼ taster kako biste izabrali : Blue Screen/Audio Language 1st/Audio Language 2nd/ Subtitle Language 1st/Subtitle Language 2nd/HDMI CEC/Menu Reset
Pritisnite ENTER /◀ / ▶ kako biste ušli.

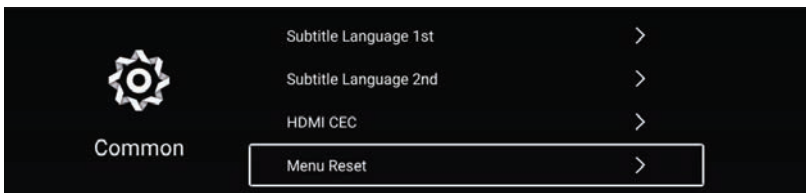
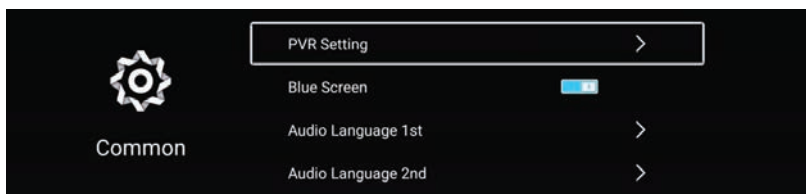

PVR Setting

Pritisnite ▲ / ▼ taster kako biste izabrali PVR Setting.

Pritisnite ◀ / ▶ kako biste izabrali Disk/Format/Record List/Schedule List.

Napomena: Ova opcija je moguća samo kada je priključen TV signal.

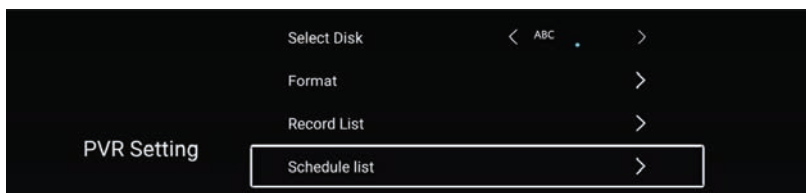

Blue Screen

Pritisnite ▲ / ▼ taster kako biste izabrali Blue Screen.

Pritisnite ◀ / ▶ kako biste izabrali ON/OFF.

Audio Language 1st /Audio Language 2nd/ Subtitle Language 1st/Subtitle Language 2nd

Pritisnite ▶ taster kako biste izabrali željeni jezik.

Napomena: Dostupno samo kada je uključen signal za TV.

DODATNA PODEŠAVANJA

HDMI CEC

Pritisnite ▲ / ▼ taster kako biste izabrali HDMI CEC.

Pritisnite ◀ / ▶ kako biste izabrali ON/OFF.

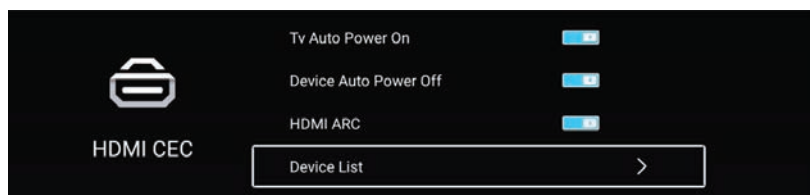
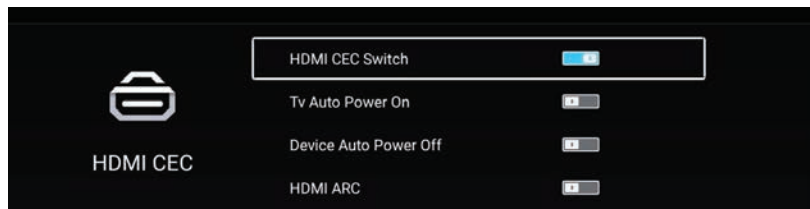

Device List

Pritisnite ▶ taster kako biste videli sve uređaje.

Menu Reset

Pritisnite ▶ taster ako se odlučite za resetovanje menija.

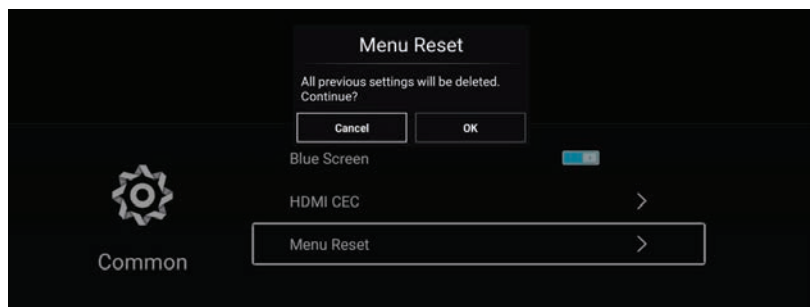

POMOĆ

Neće da se uključi ponovo ga	<ul style="list-style-type: none"> •Proverite da li jeACkabltelevizora priključen ili ne.Ako I dalje ne radi,isključite utikač I povežite nakon 60s. Ponovo uključite televizor.
Prijem signala nije dobar	<ul style="list-style-type: none"> •Dupla ili prozirna slika može se javiti ukoliko su u Vašoj blizini visoke zgrade ili planine. Prilagodite sliku manualno; proverite uputstva ili prilagodite pravac eksterne antene. •Ako koristite unutrašnju antenu, prijem signala može biti otežan pod određenim okolnostima. Prilagodite pravac antene za optimalan signal. Ako ovi kora ne poboljšaju signal, možda ćete morati da pređete na eksternu antenu.
Nema slike	<ul style="list-style-type: none"> •Proverite da li je antena na poleđini TVa ispravno povezana.. •Proverite da li se problem javlja I na drugim kanalima.
Video se javlja bez zvuka	<ul style="list-style-type: none"> •Pojačajte zvuk. •Proverite da li je MUTE uključen ili ne.
Zvuk se javlja, ali bez videa ili je video obezbojen	<ul style="list-style-type: none"> •Pokušajte da prilagodite osvetljenje i kontrast
Statički šum utiče na kvalitet videa I zvuka	<ul style="list-style-type: none"> •Proverite da li je antena na poleđini TVa ispravno povezana.
Linije po ekranu	<ul style="list-style-type: none"> •Električne naprave poput fena za kosu ili usisivača mogu uticati na rad Vašeg televizora. Isključite ove aparate.
Daljinski upravljač ne radi	<ul style="list-style-type: none"> •Osigurajte se da je plastična kesa u kojoj je daljinski dostavljen otklonjena. Pokušajte da koristite zamenite. •Televizor će preći naStandbymod, ako ne bude odgovara posle nekoliko minuta.
Nema videa (PCmod)	<ul style="list-style-type: none"> •Proverite da li je kabl ispravno povezan sa VGA ulazom ili da li je kabl savijen na nekim mestima.
Vertikalne linije (PCMod)	<ul style="list-style-type: none"> •Pristupite glavnom meniju I podesite vertikalnu poziciju kako biste ekran očistili od bilo kakvih vertikalnih linija.
Horizontalni procepi (PCMod)	<ul style="list-style-type: none"> •Podesite horizontalnu poziciju ekrana kako biste ga očistili od bilo kakvih horizontalnih linija.Ekran je previše mračan ili svetle boje (PCMod) •Podesite osvetljenje ili kontrast ekrana u glavnom meniju.
Nema PC signala	<ul style="list-style-type: none"> •Proverite da li je rezulucija PC uređaja kompatibilna sa rezolucijom televizora. Linije se pojavljuju kada je TV povezan saRCA-om. •Osigurajte se da je kalb koji koristite visokog kvaliteta.
Problemi su nerešivi I dalje	<ul style="list-style-type: none"> •Isključite strujni kabl I sačekajte 30sekundi,potom ga ponovo povežite. Ako je problem uporni,nemojte sami pokušati da popravite televizor. Molimo Vas da kontaktirate kvalifikovani servis.

Ukoliko vaš TV ima problem sa slikom nemojte ga držati dugo upaljenog jer može doći do oštećenja .

SPECIFIKACIJA

Proporcija ekrana	16:9
Sistem	PAL/SECAM BG/DK/I, DVB-T/T2+C, NTSC Playback
Impedansa koaksijalnog kabla	75 Ω
Prijem TV kanala	Ceo opseg kanala
Napajanje, voltaža	100-240V ~ 50/60Hz

Napomena: Delovi i specifikacije mogu da budu promenjene bez predhodne najave.

Daljinski upravljač:

Karakteristike: Daljinski upravljač sa svim funkcijama ima radijus rada **8 metara**

Napajanje: DC 3V (dve baterije, veličine AAA, preporuka da koristite alkalne)



	Operation Frequency	Transmitting Power
WiFi	2400~2483.5	Less Than 100mW

NAPOMENA:

NE PODRŽAVAJU SVI MOBILNI UREĐAJI FUNKCIJU DELJENJA PRIKAZA NA EKRAN TV-a. MOLIMO VAS DA PROVERITE DA LI VAŠ MOBILNI UREĐAJ PODRŽAVA OVU FUNKCIJU.

DALJINSKU UPRAVLJAČ

Tasteri daljinskog upravljača

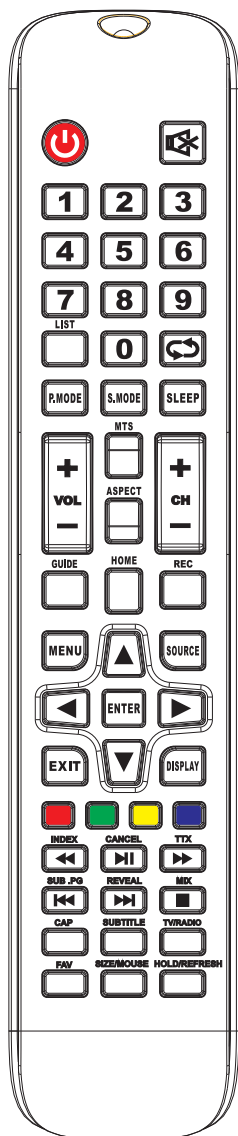

POWER : Uključuje i isključuje TV.

MUTE : Smanjuje jačinu TV-a na najmanji nivo. Pritisnite opet kako biste vratili zvuk.

NUMERIČKI TASTERI 0-9: Pritisnite 0-9 tastere TV-a kako biste izabrali kanale TV-a.

RECALL : Vraća vas na prošlu izvršenu operaciju.

S.MODE : Pritisnite za kretanje kroz zvučne režime.

SLEEP : Podesite vremenski period kada želite da se TV isključi.

MTS : Pritisnite kako biste uključili MTS mode (Nicam, BTSC, MONO, STEREO etc.)

P.MODE : Pritisnite za kretanje kroz različite režime slike.

MENU : Omogućava Vam da upravljate menijem ekrana.

SOURCE : Izaberite izvor signala.

▲ / ▼ : Koristi strelice za označavanje različitih pojmova u meniju.

◀ / ▶ : Koristi strelice za označavanje različitih pojmova u meniju.

ENTER : Potvrdite željenu operaciju.

FAV : Dodajete ili izbrisate kanale sa vaše trenutne liste.

EXIT : Izadite iz trenutne operacije koju obavljate.

DISPLAY : Očitava izvor ili informaciju o trenutnom TV kanalu.

V+ : Pojačava zvuk TV-a.

V- : Smanjuje zvuk TV-a.

HOLD/REFRESH : Teletext mod, zadrži / osveži trenutnu stranicu.

CAP : Zadrži i snimi trenutni prikaz ekrana.

PLAY/PAUSE : Pritisnite PLAY/PAUSE u USB modu.

Pokrenite PLAY i PAUSE u USB modu.

CANCEL : Otkazite ekran.

FREEZE : Zamrznete sliku.

STOP : Zaustavite playback fajlova multimedije.

MIX : TV i TXT slike su pomešane zajedno, vratite na početak snimka.

GREEN/RED/YELLOW/CYAN taster : korišćen u glavnom meniju ili Teletextu

CH+ : Promenite kanal na gore.

CH- : Promenite kanal na dole.

SET : Otvorite mrežna podešavanja u meniju.

HOME : Pritisnite da otvorite Android početnu stranicu.

LIST : Pritisnite za otvaranje liste kanala.

SIZE/MOUSE : Promenite veličinu ekrana u Teletext modu. Promenite miša.

SUBTITLE : Služi za podešavanje jezika u prevodu teksta.

BROWSER : Brzi taster za biranje pretraživača.

FF ▶▶ : Brzo premotavanje unapred u USB modu.

PREV ◀◀ : brzo premotavanje unazad u USB modu.

FR ◀◀ : Promenite na sledeće poglavlje USB mode.

NEXT ▶▶ : Promenite na sledeće poglavlje / file/ ili snimite u USB modu.

RECORD : Započnite snimanje.

SUB. PG : Pristup za podstranicu.

REVEAL : Teletext mod - za otkrivanje i skrivanje reči.

INDEX : U teletext modu prebacite na teletext stranu.

TTX : Uđite u Teletext mod.

ZAŠTITA ŽIVOTNE SREDINE



Pažnja!

Vaš proizvod je obeležen ovim simbolom. Ovaj znak označava da proizvod ne bi smeo da bude bačen zajedno sa ostalim otpadom na kraju svog životnog veka. Bilo koja koršćena elektonska oprema trebala bi da bude odvojena od običnog smeća i reciklirana u skladu sa pravilima. Prateći implementaciju sporazuma EU koji se tiču odgovornog bacanja otpada, korisnici mogu odložiti elektronski otpad na mesto odlaganja bez ikakve nadoknade. Kada kupite proizvod kontaktirajte ovlašćene zvaničnike kako biste dobili više informacija o recikliranju.

Pravilno odbacivanje otpada promovise obnovljive resurse i recikliranje. Na ovakav način utičete pozitivno na životnu sredinu i ljudko zdravlje.

Informacija za poslovanje u zemljama EU

Ukoliko je proizvod bio koršćen u poslovne svrhe, kontaktirajte vašeg prodavca i tražite informaciju kako biste skupili, odbacili i reciklirali otpad. Ako želite da odložite mali deo otpada, pronađite lokalnog sakupljača otpada.

Informacije za poslovanje van zemalja EU

Kada kupite proizvod kontaktirajte ovlašćene zvaničnike kako biste dobili više informacija.



VI 001 18

Nadamo se da ste pažljivo pročitali uputstva i da ćete ih se pridržavati.
Za više informacija o FOX uređajima posetite našu internet stranicu:

www.foxelectronics.rs