

 Pantone 1655C

 Black



FOX

Electronics Corporation Limited

MODEL:

LED TELEVIZORI



HDMI[®]
HIGH DEFINITION MULTIMEDIA INTERFACE

UPUTSTVO ZA UPOTREBU

Molimo Vas da detaljno proučite ovo uputstvo pre upotrebe televizora i da ga čuvate radi kasnije upotrebe

CONTENTS

Safety Instruction.....	2-4
Overview (Controls and Connections).....	5-6
Remote Control.....	7-8
Battery Replacement.....	9
Automatic Preset Channel.....	10
Power on/off.....	11
Channel	12-13
Picture.....	13
SCREEN.....	14
SOUND.....	14
TIME.....	15
LOCK.....	16
SETUP.....	17
USB	18-20
Menu Operation.....	21
Troubleshooting	22
Specifications.....	23





SAFETY INSTRUCTION

IMPORTANT SAFETY INSTRUCTIONS

WARNING

- TO PREVENT FIRE OR SHOCK HAZARD, DO NOT USE AN EXTENSION CORD, RECEPTACLE OR OTHER OUTLET UNLESS THE BLADES CAN BE TO PREVENT BLADE EXPOSURE.
- TO PREVENT FIRE OR SHOCK HAZARD, DO NOT EXPOSE THIS APPLIANCE TO RAIN OR MOISTURE.

 <p>This lightning flash with arrowhead symbol in an equilateral triangle alerts users to the presence of uninsulated dangerous voltage within the products enclosure that may be of sufficient magnitude to constitute a risk of electric shock to persons.</p>	<h4>CAUTION</h4> <p>RISK OF ELECTRIC SHOCK DO NOT OPEN</p> <p>Warning: To reduce the risk of electric shock, do not remove cover(or bark). No user serviceable parts inside. Refer servicing to qualified service personnel.</p>	 <p>The exclamation mark within an equilateral triangle alerts users to the presence of important operating and maintenance (servicing) instructions in the literature accompanying the appliance.</p>
---	--	--

This appliance should not be exposed to water and no object filled with liquid such as a vase should be placed on the unit.

CAUTION

- Danger of explosion if batteries are incorrectly replaced.
- Replace with only equivalent type of battery.
- Do not expose battery to direct sunlight or any other source of heat.
- Ensure proper disposal of used batteries.
- Where the MAINS plug or an appliance coupler is used as the disconnect device, the disconnect device shall remain readily operable.
- To reduce the risk of electric shock, do not perform any servicing other than what is mentioned in the operating manual.
- There are no user-serviceable parts inside the TV; do not open the TV casing.

IMPORTANT INFORMATION

If a television is not positioned in a sufficiently stable location, it can be potentially hazardous due to falling. Many injuries, particularly to children, can be avoided by taking simple precautions such as:

- Using cabinets or stands recommended by the manufacturer of the television.
- Only using furniture that can safely support the television.
- Ensuring the television is not overhanging the edge of the supporting furniture.
- Not placing the television on tall furniture (for example, cupboards or bookcases) without anchoring both the furniture and the television to a suitable support.
- Not standing the televisions on cloth or other materials placed between the television and supporting furniture.
- Educating children about the dangers of climbing on furniture to reach the television or its controls.



Safe installation

Use the belt fixing the television to facilitate restraining the television from toping forward.



SAFETY INSTRUCTION

1. **Read Instructions**-All the safety and operating instructions should be read before the appliance is operated.
2. **Retain Instructions**-The safety and operating instructions should be retained for future reference.
3. **Heed Warnings**-All warnings on the appliance and in the operating instructions should be adhered to.
4. **Follow Instructions**-All operating instructions should be followed.



5. **Water and Moisture**-The appliance should not be used near water.
6. **Cart and Stands**-The appliance should only be used with a cart or stand that is recommended by the manufacturer.
7. **Wall or Ceiling Mounting**-The appliance should be mounted to a wall or ceiling only as recommended by the manufacturer.
8. **Ventilation**-The appliance should be well situated so that its location or position does not interfere with its proper ventilation.
9. **Heat**-This appliance should be placed away from heat sources such as radiators, heat registers and stoves.
10. **Power Sources**-The appliance should only be connected to a power supply as described in the operating instructions or as marked on the appliance.
11. **Grounding or Polarization**-Precautions should be taken.
12. **Power Cord Protection**-Power supply cord should be routed so that it is not likely to be walked on, pinched by items placed upon it against the cord and its end.
13. **Cleaning**-The appliance should be cleaned only as recommended by the manufacturer.
14. **Power Lines**-An outdoor antenna should be located away from power lines.
15. **Outdoor Antenna Grounding**-If an outside antenna is connected to the receiver, the antenna system must be grounded so as to provide against voltages and built-up static charges.
16. **Non-use Periods**-The power cord of the appliance should be unplugged from the outlet when left unused for a long period of time.
17. **Object and Liquid Entry**-Care should be taken so that objects do not fall, and liquids are not spilled into the enclosure through openings.
18. **Conditions Requiring Service**-The appliance should be serviced by qualified service personnel when:
 - The power-supply cord or the plug has been damaged.
 - Objects have fallen on or liquid has been spilled into the appliance.
 - The appliance has been exposed to rain.
 - The appliance does not appear to operate normally or exhibits a marked change in performance.
19. The ventilation should not be impeded by covering the ventilation opening with items, such as newspapers, table-cloths, curtains, etc.
No naked flame sources, such as lighted candles, should be placed on the apparatus.
The apparatus shall be connected to mains socket outlet with a protective earthing connection.
The appliance coupler regard as disconnection device, the disconnect device shall remain readily operable.



SAFETY INSTRUCTION

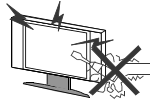

Warning

High voltages are used in the operation of this product. Do not remove the back cover of the cabinet. Refer servicing to qualified service personnel.

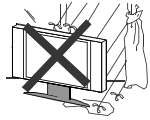

Warning

To prevent fire or electrical shock hazard, do not expose the main unit to rain or moisture.



Warning

Do not drop or push objects into the television cabinet slots or openings. Never spill any kind of liquid on the television receiver.

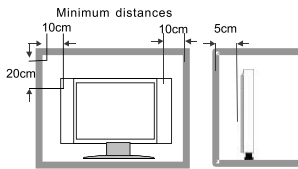

Caution

If the television is to be built into a compartment or similarly enclosed, the minimum distances must be maintained.

Heat build up can reduce the service life of your television, and can also be dangerous.



Caution

Never stand on, lean on, push suddenly the product or its stand.

You should pay special attention to children.

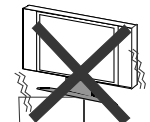

Caution

Do not place the main unit on an unstable cart stand, shelf or table.

Serious injury to an individual, and damage to the television, may result should it fall.

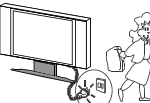

Caution

When the product is not used for an extended period of time, it is advisable to disconnect the AC power cord from the AC outlet.

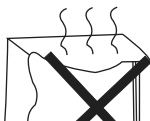

Caution

Avoid exposing the main unit to direct sunlight and other sources of heat. Do not position television receiver directly on other products which give off heat. E.g. video cassette players, audio amplifiers. Do not block the ventilation holes in the back cover.

Ventilation is essential to prevent electrical failure.

Do not squash power supply cord under the main unit.



Caution

The panel used in this product is made of glass.

It can break when the product is dropped or applied with force. Individuals should execute caution when dealing with broken glass should the panel break.



SIDE PANEL

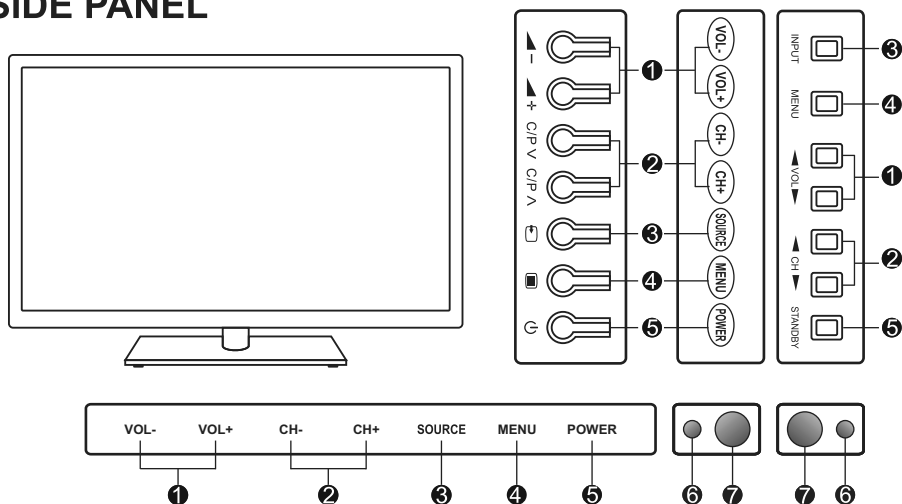

Item	Button Name	Description
①	VOL- VOL+	Turn up and down the volume. Adjust the volume of the selected menu item in the OSD menu.
②	CH- CH+	Press these buttons to select channel in ascending or descending order. Select the upper or lower menu item in the OSD menu.
③	SOURCE	Press to select the input source.
④	MENU	Enter or exit from the menu.
⑤	POWER	Switch on/off the TV when at standby mode.
⑥	Power Indicator	Illuminates red in standby mode.
⑦	Remote Sensor	Infrared sensor for the remote control.

Note:

If there is no signal input from PC for 5minutes , or no signal input from other video source (the blue background should be set to On) for over 15 minutes, the TV will switch to standby automatically. (USB not auto-standby) The power indicator will light up in red.

The user manual which relative to the TV pictures not instead of the actual pictures,pls refer to the actual pictures.

REAR AV TERMINAL CONNECTION

The TV has Large Multimedia function, it can be connected with many kinds of equipments. The following paragraph shows how it connect with other Audio and Video devices.

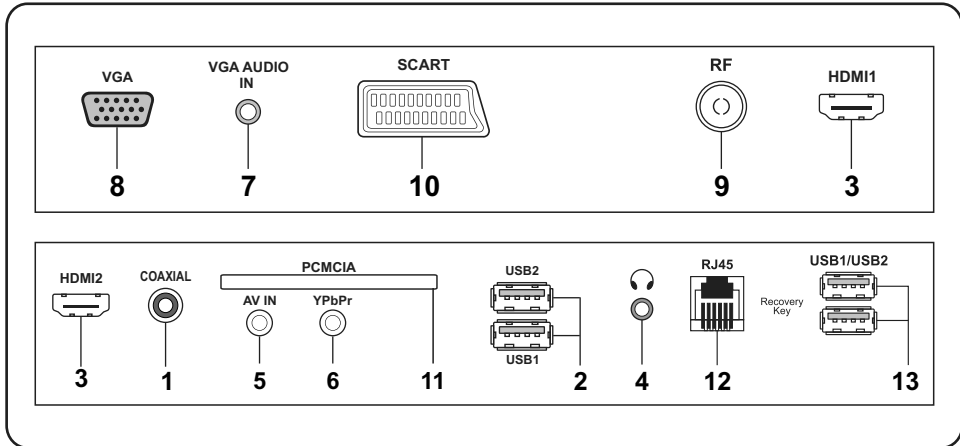

1. **COAXIAL** (Coaxial output port)
2. **USB I / USB2** (USB signal input port)
3. **HDMI I / HDMI2 / HDMI3** (HDMI signal input port)
4. **EARPHONE OUT** (Earphone output port)
5. **AV IN** (AV input port)
6. **COMPONENT IN** (YPbPr signal input port)
7. **VGAAUDIO IN** (VGA audio input port)
8. **VGA** (RGB signal input port)
9. **TERMINAL ANTENNA (75 OHM)** TV signal input port.
10. **SCART** (SCART signal input port)
11. **PCMCIA** (PCMCIA input port)
12. **RJ45 IN** (RJ45 input port)
13. **USB I / USB2 IN** (USB input port for SMARTTV)

Attentions when turn on the TV:





To match some TV designs, we set the A/C power button close to USB or HDMI interface in back cover terminal board. The first time to open the TV, need to turn on the power and the indicator will light red. And then press the "POWER" button or "⏻" in front of side cover to turn on the TV.

Note: pls refer to the sample about the user manual which relative to TV back tailgate

REMOTE CONTROLLER

The remote controller cannot be used unless it is within the receivable range. Before you use the remote control, please make sure there's no obstacle between the remote control and the receiver.



Button	Description
Power 	Switch on / off the LCD TV when at standby mode.
Mute 	Press this button to turn off the volume. Press it again to turn on the volume.
P.MODE	Picture effect selection.
S.MODE	Sound mode selection.
SCALE	Press this button to display and select available aspect modes.
AUDIO	Press this button to display and select different TV Audio systems or Language.
FAV.	Display favourite of program list.
SLEEP	Press this button to set up the TV auto turn off time.
SUBTITLE	In ATV/DTV mode open/close caption.
Number	Press to select the TV program you want to enter or input password.
STILL	Freeze picture.
SWAP 	Press this button to toggle between the current and the previous program you were viewing.
MENU	Press this button to display the main menu for adjusting the image, sound and functions. Press this button again to remove the main display.
SOURCE	Available source selection.
	Press this button to select or adjust the desired item on the TV menu.
OK (ENTER)	Press enter button to confirm or enter sub menus.
EXIT	Press this button to exit.
INFO	Display the source and channel information.
VOL+/VOL-	Press the volume button directly to turn up or turn down the sound volume level.
CH+/CH-	Press these two buttons directly to adjust the TV program.
	Use this colored buttons to operate the Teletext screen, and it depends on the local Teletext signal.
EPG	Open/close Electronic program guide.
DTV/RADIO	Switch DTV program and radio program
REC	Hotkey of PVR.

Notice: EPG, DTV/RADIO, REC MENU, REC are only effective in DTV mode.



REMOTE CONTROLLER

The remote controller cannot be used unless it is within the receivable range. Before you use the remote control, please make sure there's no obstacle between the remote control and the receiver.



Button	Description
◀ ▶	Skip a scene or music.
◀▶▶▶	Go back to the previous or skip to the next.
▶	Play/Pause
■	Stop playback

Remark: Following buttons will only work when Teletext is on (press TXT button), they will work on TV mode.

TEXT	Turn Teletext On, Press this button to display Teletext information.
HOLD	Press to freeze the the current teletext page, but the signal will continue to be broadcasted.
TIME	Press to display time informati on of Teletext.
INDEX	Press to display Teletext index.
SIZE	Teletext Size selection.
REVEAL	Press to reveal hidden Teletext index.

Different area ,the key of the remote control have different function. Pls take the remote control as the actual one.

Battery replacement

BATTERY INSTALLATION OF REMOTE CONTROL UNIT

1. Open the battery compartment cover.

2. Insert two “AAA” (pencil size) 1.5V batteries. Make sure the polarity (+ or -) of the batteries matches the polarity marks inside the unit.

3. Close the battery compartment cover.

NOTE:

- The life time of the batteries may last up to one year, depending on how often the remote control is used. For the best performance, the batteries should be replaced on a yearly basis, or when remote operation becomes erratic.
- Be sure to place the batteries in the correct direction, as shown left.
- Do not mix old and new batteries, or different types.
- Old batteries may leak chemical and damage the remote control. Always remove batteries as soon as they become weak.

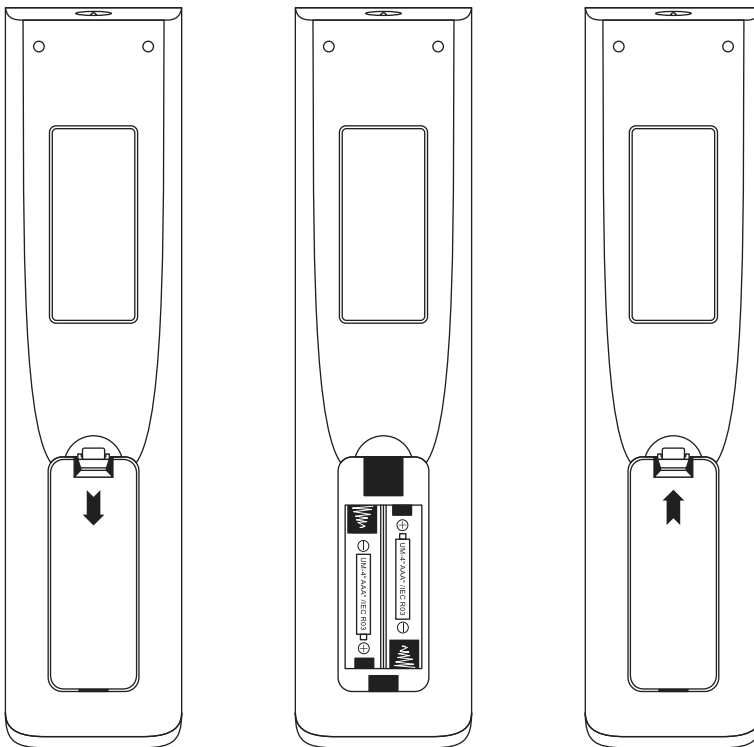

AUTOMATIC PRESET CHANNEL

SIDE PANEL

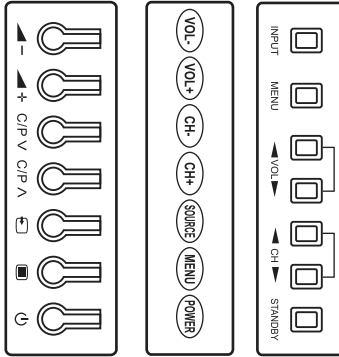

REMOTE CONTROL PANEL

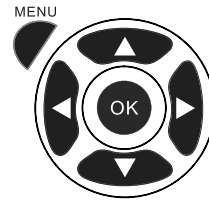

VOL- VOL+ CH- CH+ SOURCE MENU POWER

1. Connect your cable or Antenna to the Terminal Antenna Jack.
2. Press the menu button on the TV set or on the remote control until you see the 'CHANNEL' menu.
3. Press the ▲ / ▼ button on the remote control to select Auto Tuning item.
4. Press the OK or ► button on the remote control to display submenu, press the ▲/▼/◀/▶ button on the remote control to select items, then press the OK button to begin searching and the TV will find all available channels. In the course of the auto tuning, press 'MENU' button to display 'Do you want to exit tuning ◀ Yes No ▶', and press the ◀ button to exit auto tuning.

Note:

- Please be patient as it will take a few minutes to find all channels.

Now You're Ready to Watch TV

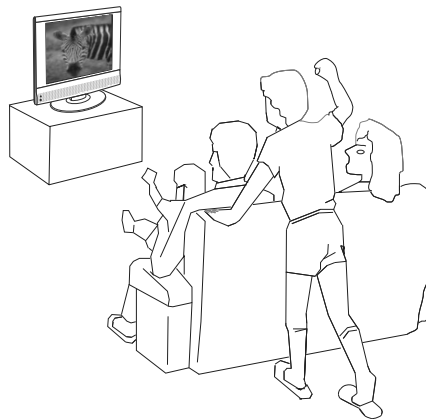

Power On/Off

1. Connect the TV to power source using power cord.
2. When the power indicator is red ,the TV is in standby mode. Now press the "POWER" button on remote Control or "POWER " button on front panel to turn on the TV.
3. To switch the TV back to standby mode, just press "POWER" button on the remote control or the "POWER " button on front panel. Now the indicator will be red.
4. If unused for a long time in standby mode, please disconnect the power cord from the wall outlet.

CHANNEL

CHANNEL menu

Press "MENU" and "◀/▶" buttons to select the CHANNEL menu.

Press "▼/▲" button to select the items.

Press OK button to enter the submenu.



Auto Tuning: Press [▶] or [OK] to start auto tuning of both ATV and DTV channels.

ATV Manual Tuning: Press [▶] or [OK] to enter "ATV Manual Tuning" submenu.

Current CH: Press [◀▶] to select the channel number you want to store.

Color System: Press [◀▶] to change the color system as Auto, SECAM, PAL.

Sound System: Press [◀▶] to change the sound system as DK, I, BG, L.

Fine-Tune: Press [◀▶] to scan current program within a frequency range accurately and store the result manually.

AFC: Set the Automatic Frequency Control to "On" or "Off".

Search: Press [◀▶] to start search.

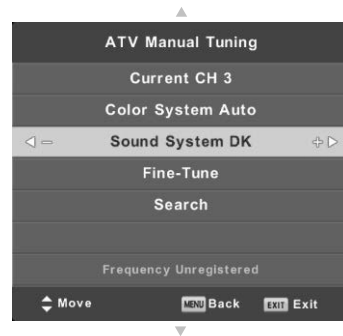

DTV Manual Tuning: Press [▶] or [OK] to enter "DTV Manual Tuning" submenu.

Press [◀▶] to select channel, then press [OK] to search programs.

Note: Only channels with sufficient signal strength will be tuned in: check your antenna if channels are missing after Auto Tuning.



CHANNEL

Programme Edit: Press [▶] or [OK] to enter "Programme Edit" submenu.

This option has five functions:

1. Press Red button to delete the current channel.
2. Press Yellow button and [▲/▼] to move the current channel.
3. Press Blue button to skip the current channel.
4. Press [FAV] to set the current channel to your favorite channel, there will be a red heart at the behind of the channel selected. If the current channel is already be one of your favorite channel, press it again will set it to a normal one.

Schedule List

Display Schedule List and Recorded List.

Signal Information:

Display the signal information in DTV mode.

CI Information:

Please contact your "pay per view" provider who can supply a viewing card and cam unit with instructions for their use.

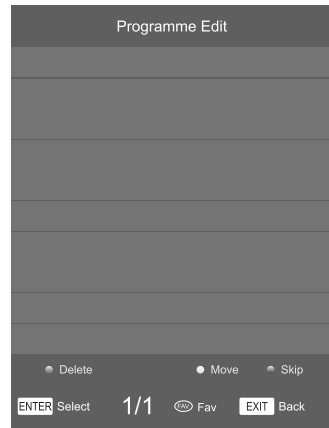

PICTURE

PICTURE menu

Press [MENU] to display the main menu.

Press [◀▶] to select "PICTURE" in the main menu, then press [▼] or [OK] to enter.



Picture Mode: Press [◀▶] or [OK] to enter "Picture Mode" submenu. Press [▲/▼] to change the picture mode in sequence: Dynamic → Standard → Mild → Personal.

You can press [P.MODE] repeatedly on the remote control to change the picture mode directly.

Contrast: Press [◀▶] or [OK] to enter submenu. Press [◀▶] to set the picture's contrast intensity.

Brightness: Press [◀▶] or [OK] to enter submenu. Press [◀▶] to set the picture's brightness.

Colour: Press [◀▶] or [OK] to enter submenu. Press [◀▶] to set the picture's colour intensity.

Tint: Press [◀▶] or [OK] to enter submenu. Press [◀▶] to set the picture's tint. (Available for NTSC video signal only)

Sharpness: Press [◀▶] or [OK] to enter submenu. Press [◀▶] to set the picture's sharpness.

Colour Temp: Press [◀▶] or [OK] to enter "Colour Temp" submenu. Press [▲/▼] to change the colour temperature in sequence: Cold → Normal → Warm.

Noise Reduction: Press [◀▶] or [OK] to enter "Noise Reduction" submenu. Press [▲/▼] to change the noise reduction in sequence: Off → Low → Middle → High → Default.

SCREEN

Press the "SOURCE" button on the remote control to enter the OSD menu, then press "▲/▼" button to select "SCREEN" item. Press "OK" button to enter "SCREEN" mode.

SCREEN (Only available when connected via SCREEN to a PC)

Automatic adjust the picture of the right size.

Press "▲/▼" button to select "Auto Adjust" or "Position Reset" item.

Press [▶] or [OK] button to Adjust.

Press "▲/▼" button to select "H-Offset", "V-Offset", "Size" or "Phase" of the project.

Press "◀/▶" button to adjust.



SOUND

SOUND menu

Press [MENU] to display the main menu.

Press [◀▶] to select "SOUND" in the main menu, then press [▼] or [OK] to enter.

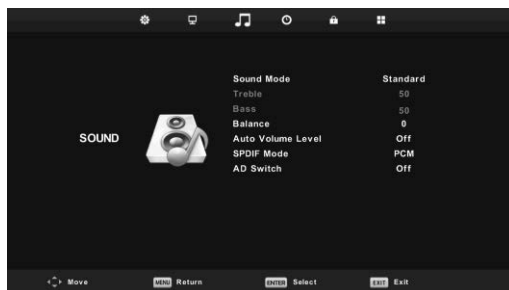

Sound Mode: Press [◀▶] or [OK] to enter "Sound Mode" submenu. Press [▲/▼] to change the sound mode in sequence: Standard → Music → Movie → Sports → Personal.

You can press [S.MODE] repeatedly Treble: Pree [◀▶] or [OK] to enter submenu. Press [◀▶] button to adjust.

Balance: Press [◀▶] or [OK] to enter Bass: Pree [◀▶] or [OK] to enter submenu. Press [◀▶] button to adjust speaker's balance.

Auto Volume Level: Press [◀▶] or [OK] to set the automatic volume level to "On" or "Off".

SPDIF Mode: Press [◀▶] or [OK] to set the SPDIF mode to "Auto", "Off" or "PCM".

AD Switch (For DTV only): Press [▶] or [OK] to enter submenu. Press [◀▶] to select the audio descriptor to "On" or "Off" as well as adjust the volume of the AD.

TIME

TIME menu

Press [MENU] to display the main menu.

Press [◀▶] to select "TIME" in the main menu, then press [▼] or [OK] to enter.



Clock: Use the ◀/▶ buttons to select the position, and use the ▲/▼ buttons to set the time.

Note: User can not change time manually during DTV mode, for time is from signal source directly.

Time Zone: Press [OK] to enter submenu. Press [▲▼◀▶] to select items, press [OK] to confirm.

Sleep Timer: Press [▶] or [OK] to enter "Sleep Timer" submenu. Press [▲▼] to change the sleep timer as Off, 15Min, 30Min, 45Min, 60 Min, 90 Min, 120 Min, 240 Min.

You can press [SLEEP] repeatedly on the remote control to change the sleep timer directly.

Auto Standby: Press [OK] to enter submenu. Press [▲▼] to select Off, 3 H, 4 H, 5 H, press [OK] to confirm.

OSD Timer: Press [▶] or [OK] to enter submenu. Press [▲▼] to change the OSD timer as 5 Seconds, 15 Seconds, 30 Seconds.



LOCK

LOCK menu

Press [MENU] to display the main menu.

Press [◀▶] to select "LOCK" in the main menu, then press [▼] or [OK] to enter.



Password: Enter the default password "0000" to go to the LOCK function menu if you have set "Lock System" to "On".

Lock System: Set the lock system to "On" or "Off" which enables or disables below lock functions.



Set Password: Press [▶] or [OK] to enter submenu to set new password.

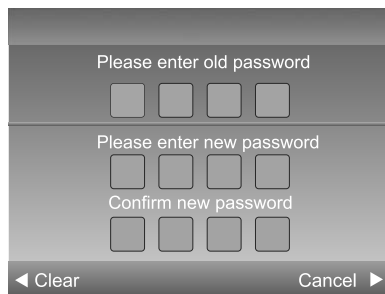

You can change the password by entering the old and a new password and then re-entering it to confirm the new one.

Channel Lock : Press [OK] to display Channel Lock menu.

Parental Guidance: Press [OK] to display submenu, press [▲/▼] to select Off, 3,4, 5, 6, 7, 8, 9, 10, 11, 12, 13, 14, 15, 16, 17, 18. Press [OK] to confirm.

Keyboard Lock: Press [OK] to select Off or On.

SETUP

SETUP menu

Press [MENU] to display the main menu.

Press [◀▶] to select "SETUP" in the main menu, then press [▼] or [OK] to enter.



OSD Language

Press OK button to enter and◀/▶,▼/▲ button to select OSD language.

Press "MENU" button to return to the previous menu.

TT Language: Press [OK] to enter submenu, press [▼/▲] to select items. Press [OK] to confirm.

Audio Languages / Subtitle Language: Press [OK] to enter submenu, press [◀▶▼▲] to select items. Press [OK] to confirm.

Hearing Impaired (For DTV only):

Press [◀▶] or [OK] to set the hearing impaired to "On" or "Off".

PVR File System (For DTV only):

Press [▶] or [OK] to enter the submenu to check the USB connected and provide with the recording function.

Scale: Press [OK] to enter submenu, press [▼/▲] to select the aspect ratio mode. Press [OK] to confirm.

Blue Screen

Press OK button to select On or Off.

First Time Installation: Press [▶] or [OK] to enter relevant options including OSD Language and Country.

Reset

This will reset all settings to default. Press OK button to start - you will be asked to confirm (see screenshot right).

Press "◀/▶" button to select Yes or No.

Press "MENU" or "EXIT" button to return.

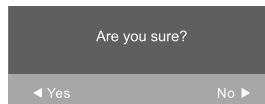

Software Update(USB) : Press [▼/▲] to select Software Update item. Press [OK] to confirm.

Note: User only on advice from Customer Support.

USB

Press "SOURCE" button to POP-UP the input source menu.

Press "▲/▼" button to select "Media" and press "OK" button to enter the interface, as shown below:

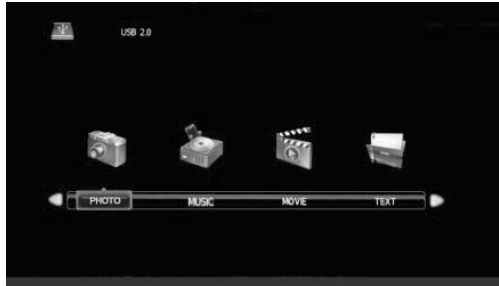

Press "◀/▶" button to select among the "PHOTO", "MUSIC", "MOVIE" and "TEXT" icons.

Press "OK" button to confirm and enter the next menu, as shown below:



PHOTO

Press OK to select files (indicated with a checkmark) for selective playback (see 6 below).

1. Press "◀/▶" button to select "PHOTO".
2. Press "OK" button to enter the disk selection menu.
3. Press "◀/▶" button to select disk to enter the submenu.
Select ↶ item to return to the previous menu.
4. Press "▲▼◀▶" button to select the image file you want to play. Press OK to select files (indicated with a checkmark) for selective playback. Press red button, you will enter the submenu to delete the file.
5. Press "PLAY" button to play photo slideshow (of checkmarked files; if no files are ticked, all pictures will play), press "OK" button to display menu.

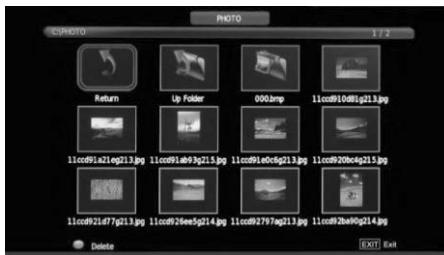

USB

Pause

Press "PAUSE" button to pause the slideshow.

Play

Press "PLAY" button to play the selected photo.

Stop

Press "STOP" button to stop and return.

Next/Prev.

Press "NEXT" or "PREV." button to skip to view the photo which are selected the photo.

Exit

Press "EXIT" button to exit.



MUSIC

1. Press "◀/▶" button to select "MUSIC".
2. Enter the music interface, press "▲▼◀▶" button to preview the music, as shown below:



3. Press "PLAY" button into music player and playing the selected music, as shown below:

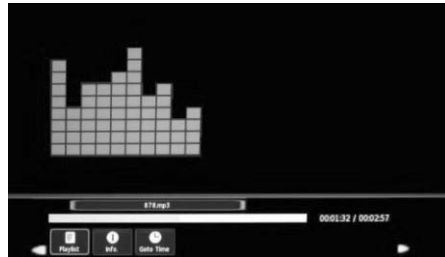
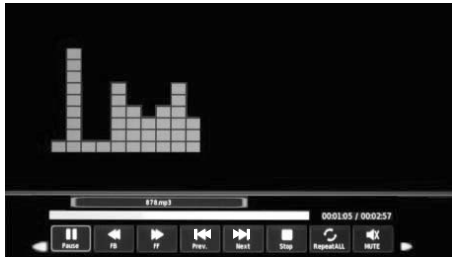

PAUSE

Select "PAUSE" to pause the playing music.

PLAY

Select "PLAY" to play the music.

FB

Select "FB" to fast reverse among 2X, 4X, 8X and 16X modes.

FF

Select "FF" to fast forward among 2X, 4X, 8X and 16X modes.

PREV.

Select "PREV." to skip to previous track.

NEXT

Select "NEXT" to skip to next track.

STOP

Select "STOP" to stop and return.

RepeatALL

Select "🔄" to repeat play music (🔄 Repeat 1, 🔄 Repeat All, 🔄 Repeat None).

MUTE

Select "MUTE" to turn off the sound.

USB

- Playlist** Select "Playlist" to display play list.
- Info.** Select "Info" to display the music information.
- Goto Time** Select "Goto Time" to setup play time.

MOVIE

1. Press "◀/▶" button to select "MOVIE"
2. Enter the movie interface, Press "▲▼◀▶" button to preview the files, as shown below.:



3. Press "PLAY" button to play the movie. Press OK button to display menu.
Press the "PLAY" button once more to play the movie full-screen.
Press the "PAUSE" button to pause the playing movie.
Press "PREV." or "NEXT" button to skip the backward or forward. Press "FB" OR "FF" button to fast reverse or fast forward, press "STOP" or "EXIT" button to return.

TEXT

1. Press "◀/▶" button to select "TEXT" (to view text documents stored on USB).
2. Enter the text interface, Press "▲▼◀▶" button to preview the files, as shown below.:



3. Press "PLAY" button to open and play the file, press OK button to display menu. as shown below.:
- Select "Prev Page" to view a next page.
 - Select "Next Page" to view a previous page.
 - Select "STOP" to return.
 - Select "Music" to listen to music while reading.









1. Read these instructions.
2. Keep these instructions.
3. Heed all warnings.
4. Follow all instructions.
5. Do not use this apparatus near water.
6. Clean only with dry cloth.



MENU OPERATION

MULTIMEDIA

Key function list

	Stop Playback
↑ ↓ ← →	direction key (record program detailed information)
INFO 	show details
	Play
	Pause
	fast reverse
	fast forward
	Previous
	Next
RED	Delete
OK	Confirm
EXIT	Exit
SUBTITLE	When playing the movies, turn on or off the SUBTITLE function need the support of the movies' source.

Note: Please use high-speed mobile disk

The following are the function interfaces of the PHOTO, MUSIC, MOVIE and TEXT. About their functions described please refer to the Key function list in page 19.

PHOTO



MUSIC



MOVIE



TEXT



NOTE: In the USB playback multimedia, according to the "INFO" rid device info popup menu button above.

TROUBLE SHOOTING GUIDE

Before contrast the service technician, perform the following simple checks. If any problem still persists, unplug the LCD TV and calling for serving .

Problem	Possible Solution
No sound or picture	<ul style="list-style-type: none"> ● Check that the main plug has been connected to a wall let. ● Check that you have pressed the  button on the front of the TV. ● Check the picture contrast and brightness settings. ● Check the volume.
Normal picture but no sound	<ul style="list-style-type: none"> ● Check the volume. ● Check whether the MUTE button was pressed on the remote control.
Sound is too low	<ul style="list-style-type: none"> ● Check the volume. ● If the volume is still too low after setting the volume level to its maximum, check the volume control on computer sound card or software program.
No picture or black and white picture	<ul style="list-style-type: none"> ● Adjust the colour settings . ● Check whether the broadcast system selected is correct.
“Unknown” message	<ul style="list-style-type: none"> ● Make sure that the power cord is firmly connected to the PC or the video sources. ● Make sure that the PC or video sources are switched on.
Sound and picture interference	<ul style="list-style-type: none"> ● Try to identify the electrical appliance that is affecting the set and move it further away.
Blurred or snowy picture, distorted sound	<ul style="list-style-type: none"> ● Check the direction, location and connections of your aerial.
Remote control does not work	<ul style="list-style-type: none"> ● The battery in the remote control may be exhausted. ● The battery may be improperly installed. ● Check that there is no obstacle between the remote control and the remote (infrared) sensor. ● Ensure that there is no strong light shining on the remote control's infrared sensor.
The LCD TV does not turn on	<ul style="list-style-type: none"> ● Be sure the power cord is plugged on.
The image is too light or too dark	<ul style="list-style-type: none"> ● Adjust the brightness and Contrast.
On PC mode, horizontal bars appear to flicker, jitter or shimmer on the image	<ul style="list-style-type: none"> ● Adjust the Phase.
On PC mode, vertical bars appear to flicker, jitter or shimmer on the image	<ul style="list-style-type: none"> ● Adjust the Clock.
On PC mode, image is not stable and may appear to vibrate	<ul style="list-style-type: none"> ● Check the display resolution and frequency from your PC or video board is a valid mode for your LED TV. Control Panel→ Display→ Settings. ● If the setting is not correct, use your computer utility program to change the display settings. Your monitor supports multi display function within the following frequency domain:
On PC mode, image is not centred on the screen.	<ul style="list-style-type: none"> ● Adjust the horizontal and vertical position.

SPECIFICATIONS

Aspect Ratio	16 : 9
System	PAL/SECAM BG/DK/I, DVB-T/T2+C , NTSC Playback
Base impedance	75 Ω (Unbalance)
Receiving TV Band	All Channels Receiveable
AC Supply Voltage	100-240V~ 50/60Hz

Note: Part of the design and the specification may be changed without prior notice.

INFRA-RED REMOTE CONTROL

Features: Full function remote control

Effective Distance Power: 8 metres

Power Supply: DC 3V (Two batteries, size AAA, recommend use alkaline type batteries)

 Pantone 1655C

 Black



FOX

Electronics Corporation Limited

MODEL:

LED TELEVIZORI



HDMI[®]
HIGH DEFINITION MULTIMEDIA INTERFACE

UPUTSTVO ZA UPOTREBU

Molimo Vas da detaljno proučite ovo uputstvo pre upotrebe televizora i da ga čuvate radi kasnije upotrebe

SADRŽAJ

Bezbedosna uputstva	2-4
Pregled (komandi i priključaka)	5-da
Daljinski upravljač	7-8
Zamena Baterije.....	9
Automatsko memorisanje kanala	10
Paljenje i gašenje	11
Kanal	12-13
Slika	13
EKRAN	14
Zvuk	14
VREME	15
ZAKLJUČAVANJE	16
Podešavanje	17
USB	19-20
Meni operacije	21
Problemi	22
Specifikacija.....	23





BEZBEDONOSNA UPUTSTVA

VAŽNA BEZBEDONOSNA UPUTSTVA

UPOZORENJE

KAKO BISTE SPREČILI POŽAR ILI ELEKTRIČNI UDAR NEMOJTE KORISTITI PRODUŽNI KABAL, DUPLI UTIKAČ ILI DRUGE DODATKE NA UTIČNICI OSIM ONIH KOJI BI MOGLI DA SPREČE IZAZIVANJE STRUJNOG UDARA

- KAKO BISTE SPREČILI POŽAR ILI ELEKTRIČNI UDAR NE IZLAŽITE OVAJ UREĐAJ VLAGI ILI KIŠI..

 <p>Ovaj simbol munje u jednakostranom trouglu upozorava korisnike na prisustvo opasnog i neizolovanog napona unutar kućišta proizvoda koji može biti dovoljan da stvori rizik STRUJNOG UDARA</p>	<p>CAUTION</p> <p>RISK OF ELECTRIC SHOCK DO NOT OPEN</p> <p>Upozorenje: Da biste smanjili rizik od strujnog udara, nemojte skidati poklopac (ili zadnju stranu). Unutra nema delova koje korisnik može sam da zameni. Za obavljanje servisa zatražite pomoc kvalifikovanog osoblja</p>	 <p>Znak uzvika unutar jednakostranog trougla u ovom uputstvu upozorava korisnika na prisustvo važnih instrukcija za rad i održavanje (servisiranje) uređaja.</p>
--	---	---

Ovaj aparat ne treba izlagati void, a predmete ispunjene tečnošću poput vaza ne treba da budu postavljeni na i

oko uređaja.

OPREZ

- * Postoji opasnost od eksplozije ako se baterija nepropisno zameni.
- * Zamenite postojeću sa samo odgovarajućom vrstom baterija.
- * Nemojte izlagati bateriju direktnoj sunčevoj svetlosti ili bilo kojem drugom izvoru toplote.
- * Obezbedite pravilno odlaganje istrošenih baterija.
- * Ostavite lako dostupnim mesto gde je utikač ili nastavak za prekid napajanja.
- * Da biste smanjili rizik od strujnog udara, ne obavljajte bilo kakvo servisiranje osim onih koja se pominju u

VAŽNE INFORMACIJE

Ako televizor nije postavljen na dovoljno stabilnom mestu, može postojati potencijalna opasnost od pada. Mnoge povrede, posebno na deci, mogu se izbeći primenom jednostavnih mera opreza kao što su:

- * Korišćenje elemenata ili stalaka koje je preporučio proizvođač televizora.
- * Korišćenje samo onog nameštaja koji može da sigurno podrže uređaj.
- * Obezbeđivanje uređaja tako da ne prelazi ivicu nameštaja.
- * Nepostavljanje TV-a na visok nameštaj (na primer, ormare ili police) bez prethodnog pričvršćivanja kako nameštaja tako i uređaja na odgovarajuću površinu.
- * Ne pokrivanje televizora krpom i nestavljanje drugih materijala između televizora i nameštaja na kom stoji.



* Sigurna instalacija

- * Koristite pojas za fiksiranje televizora kako
- * bi sprečili uređaj od pada unapred..



Sigurnosne napomene

1. Pročitajte uputstva - Sve napomene o sigurnosti i operativni treba pročitati pre aparat radi.
2. Sačuvajte uputstva - Uputstva za sigurnost i uputstvo za upotrebu treba da se sačuvaju za buduće potrebe.
3. Imajte u vidu Upozorenja - Svih upozorenja na aparatu i u uputstvu za upotrebu treba se pridržavati.
4. Pratite uputstva - Treba pratiti sva uputstva..



5. Voda i vlažnost - Aparat ne treba koristiti u blizini vode.
6. Nosač i postolja - Aparat treba koristiti samo sa nosačem ili postoljem koji preporučuje proizvođač.
7. Montaža na zid ili plafon - Aparat treba da se montira na zid ili plafon samo po preporuci proizvođača
8. Ventilacija - Aparat treba da bude dobro postavljen, tako da njegova lokacija ili pozicija ne ometaju njegovo dobro provetravanje.
9. Toplota - Ovaj aparat treba postaviti dalje od izvora toplote kao što su radijatori i peći.
10. Napajanje - Aparat treba povezati samo na napajanje kao što je opisano u uputstvima za upotrebu ili onako kako je naznačeno na uređaju.
11. Uzemljenje ili polarizacija - Treba preduzeti mere predostrožnosti.
12. Zaštita kabla za napajanje - Naponski kabl treba da bude usmeren tako da je malo verovatno da se može gaziti, prikleštiti stvarima na njemu ili njegovom kraju.
13. Čišćenje - Aparat bi trebalo čistiti samo po preporuci proizvođača:
14. Napajanje spoljne antene treba da se nalazi daleko od dalekovoda.
15. Uzemljenje spoljne antene - Ako je spoljna antena povezana na prijemnik, antenski sistem mora biti uzemljen kako bi se obezbedila zaštita od naponskog i izvornog statičkog elektriciteta.
16. Kada ga dugo ne koristite - napajanje uređaja trebalo bi da bude isključeno iz utičnice kada se ne koristi duži vremenski period.
17. Upad predmeta i tečnosti - Treba paziti da se predmeti ne upadnu, a tečnost ne prospe u kućište kroz otvore.
18. Kada je potreban servis - Aparat treba da servisira kvalifikovano servisno osoblje kada su:
 - kabl za struju ili utikač oštećeni.
 - kada predmeti upadnu ili kada je tečnost prolivena u uređaj.
 - kada je aparat izložen kiši.
 - kada aparat ne radi normalno ili pokazuje značajnu promenu u radu.
19. Ventilacioni otvori ne bi trebalo da budu pokriveni predmetima, kao što su novine, tkanine, zavese, itd.
20. Izvore otvorenog plamena, kao što su upaljene sveće, ne bi trebalo da stoje na aparatu.
21. Aparat će biti povezan sa mrežnom utičnicom sa zaštitnim uzemljenjem. Utičnica ili nastavak za prekid napajanja trebaju da budu lako dostupni.

SAFETY INSTRUCTION

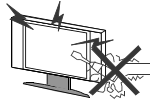

Upozorenje

Visok napon se koristi u funkcionisanju ovog proizvoda. Ne uklanjajte zadnji poklopac. Obratite se se kvalifikovanoj osobi za obavljanje servisa.

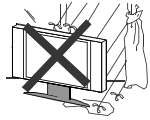

Upozorenje

Ja biste sprečili požar ili strujni udar, nemojte izlagati uređaj kiši ili vlazi.



Upozorenje

Nemojte ispuštati i gurati predmete u kućiste TV-a ili u otvore. Nikada nemojte prosipati tečnost na TV prijemnik

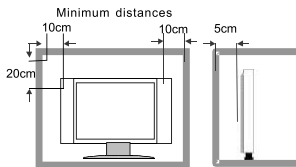

OPREZ

Ako televizor treba da se ugradi u zatvoreni odeljak ili na sličan način, morate se pridržavati dela uputstva o minimalnim udaljenostima. Toplota može smanjit životni vek televizora, a takodje može biti opasno.



Opresz

Nikad nemojte da stanete ili se oslonite ili gurnete uređaj ili stalak. Treba obratiti posebnu pažnju na decu.

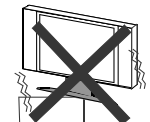

Opresz

Ne stavljajte glavnu jedinicu na nestabilno postolje, policu ili sto.

Usled pada mođe doći do ozbiljne povrede lica ili štete na na televizoru.

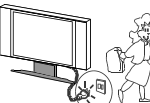

Opresz

Kada se proizvod ne koristi za duži vremenski period, preporučljivo je da isključite mrežni kabl iz utičnice.

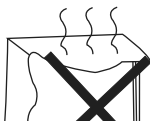

Opresz

Izbegavajte izlaganje glavne jedinice direktnom suncu i drugim izvorima toplote. Ne postavljajte televizor na druge proizvode koji emituju toplotu. Na primer: Video uređaji, audio pojačala. Ne blokirajte otvore za ventilaciju u zadnjem poklopcu. Ventilacija je od suštinskog značaja za sprečavanje električnih kvarova. Ne savijajte kabl za napajanje ispod glavne jedinice.



Opresz

Panel (ekran) koji se koristi u ovom proizvodu je napravljen od stakla. Mođe se slomiti padom uređaja ili nasilnim udarom. Pojedinci treba oprezno da rade arzbijenim staklom ekrana



PANEL SA STRANE

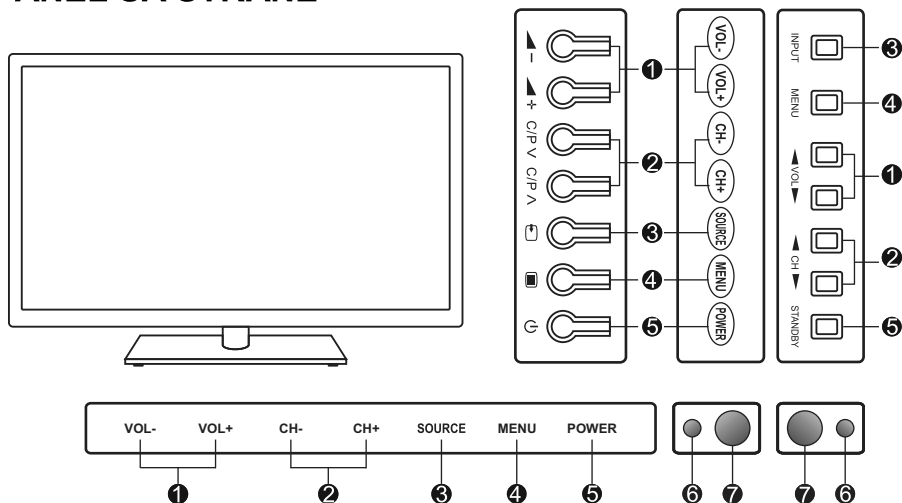

	naziv	opis
❶	VOL- VOL+	Pojačavanje I smanjivanje zvuka..
❷	CH- CH+	Pritiskom na ove tastere vršte promenu kanala na više i na niže.
❸	SOURCE	Pritisnite da izaberete izvor signala
❹	MENU	Ulaz ili izlaz iz MENI-ja
❺	POWER	Upaliti / Ugasiti TV kada je u Stand By modu.
❻	Indikatr napona	Svetli crveno kada je u stand by modu.
❼	Senzor daljinskog upravljača	Infracrveni senzor za daljinski upravljač.

Note:

Ako nema signala sa PC 5 sekundi ili nema signala sa drugih video izvora(palvi ekran će biti upaljen) preko 15 minuta, vaš TV uređaj će se ugasisi automatski. I Indikator napona će svetleti crveno.

KONEKCIJE POZADI

Tv ima veliki izbor multimedijalnih funkcija, i može biti povezan sa puno vrsta različitih uređaja. Sledeći paragraf kako se povezije sa drugim Audio i Video urđajima.

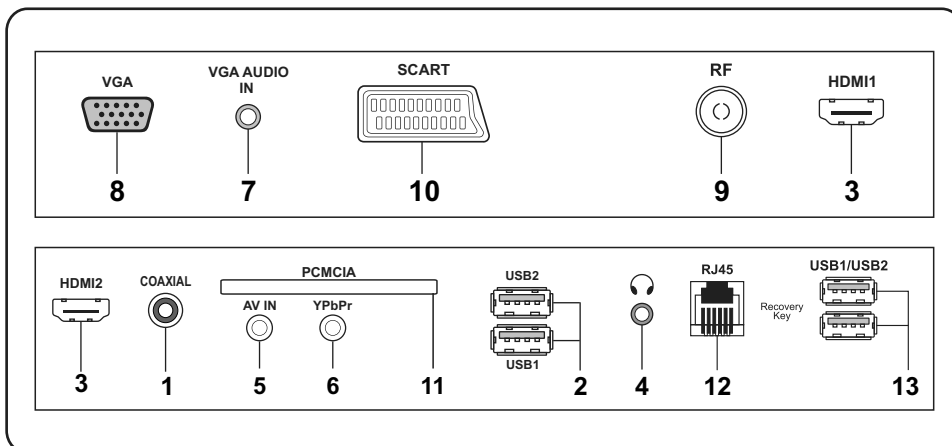

1. **COAXIAL (Coaxial izlazni port)**
2. **USB1 / USB2 (USB signal ulazni port)**
3. **HDMI1 / HDMI2 / HDMI3 (HDMI ulazni port)**
4. **EARPHONE OUT (Izlazni port za slušalice)**
5. **AV IN (AV ulaz)**
6. **COMPONENT IN (YPbPr signal ulazni port)**
7. **VGA AUDIO IN (VGA audio ulazni port)**
8. **VGA (RGB ulazni port)**
9. **TERMINAL ANTENNA (75 OHM) TV ulazni port.**
10. **SCART (SCART ulazni port)**
11. **PCMCIA (PCMCIA ulazni port)**
12. **RJ45 IN (RJ45 input port)**
13. **USB1 / USB2 IN (USB input port for SMART TV)**





Pažnja, kada je uključen TV:

Da bi postigli dizajn TV-a mi smo prekidač A/C postavili blizu USB i HDMI na zadnjoj tabli. Prvi put kada raspakujete TV, potrebno je da upalite TV na prekidaču i indikator će zasvetleti. Zatim pritisnite POWER na daljinskom da bu upalali TV..

DALJINSKI UPRAVLJJAČ

Daljinski upravljač se ne može koristiti ukoliko nije u u spektru prijemnika TVa.Pre nego što koristite daljinski upravljač, uverite se da nema fizičkih prepreka između TV i daljinskog upravljača.



Button	OPIS
Power 	Pali se i gasi TV kada je u Stand by modu..
Mute 	Pritisnite ovaj taster da bi ste isključili zvuk. Pritisnite opet ovaj taster da bi ste uključili zvuk..
P.MODE	Izbor efekata slike
S.MODE	Izbor moda zvuka..
SCALE	Oritisnite ovaj taster i izaberite ASPECT slike
AUDIO	Pritisnete ovaj taster da izaberete druge TV Audio sisteme i jezike.
FAV.	Prikas omiljenih programa.
SLEEP	Pritisnite ovaj taster da izabereta vreme za koliko će se TV sam ugasiti
SUBTITLE	U DTV modu otvara i zatvara Titlove
Number	Pritisnite da izaberete TV program koji želite, ili da unesete šifru.
STILL	Zalediti sliku(ekran).
SWAP 	Pritisnite ovaj taste da promenite između trenutnog i prethdnog kanal koji ste gledali
MENU	Pritisnite ovaj taster da prikazete glavni MENI za podešavanje slike, zvuka i funkcija.Pritisnite ponovo ovaj taster da isključite glavni MENI
SOURCE	Izbor dostupnih izvora
	ZA izbor ili podešavanje željenih stavri u MENI-u TV-a
OK (ENTER)	Pritisnite da potvrdite ili uđete u pod meni.
EXIT	Pritisnite da izađete.
INFO	Prikaz izvora i inforamcija kanala
VOL+ /VOL-	Za pojačivanje i smanjenje nivoa zvuka.
CH+ /CH-	Za promenu TV programa.
	Koristite za kontrolu Teletecta.
EPG	Otvara i zatvara EPG (Elektronski programski vodič)
DTV/RADIO	Menja DTV program i radio program
REC	Prčica za PVR.

Napomena: EPG, DTV/FIADIO, REC MENU, REC imaju funkciju samo u DTV mode.



DALJINSKI UPRAVLJJAČ

Daljinski upravljač se ne može koristiti ukoliko nije u u spektru prijemnika TVa.Pre nego što koristite daljinski upravljač, uverite se da nema fizičkih prepreka između TV i daljinskog upravljača.



Button	Opis
◀ ▶	Preskoči scenu ili pesmu.
◀ ▶▶	Idi nazad na prethodnu ili na sledeću
▶	Play/Pause
■	Stop playback

Napomen: Sledeći tasteri će raditi samo kada je uključen Teletext(pritisnite TXT taster),radiće u TV modu.

TEXT	Uključuje Teletext,pritisnite ovaj taster da prikaže informacije o Teletekstu.
HOLD	Pritisnite da zanrznete teletext stranicu, ali signal će da nastavi prijem..
MIX	Pritisnite ovaj taster da izaberete prikaz Teleteksta izmedju samo teleteks ili pomešan teletekst i slika.
INDEX	Pritisnite da dobijete informacije o indexu
SIZE	Izbor fveličine texta
REVEAL	Pritisnite da oslobodite teletext posle HOLD funkcije

Different area ,the key of the remote control have different function. Pls take the remote control as the actual one.

Zamena baterije

Instalacija baterije

1. Otvorite poklopac .

2. Ubacite dve " AAA " 1.5V baterije. Uverite se da polaritet (+ or -) baterija se poklapa sa polaritetom obeleženim na na daljinskom.

3. Zatvorite poklopac.

NAPOMENA:

- Životni vek baterija je do godinu dana, u zavisnosti koliko se koristi daljinski. ZA najbolje performanse baterije se trebaju menjati na godišnjem nivou, ili kada daljinski počne da slabije šalje signal.
- Uverite se da se baterije postavu u ravom smeru.
- Ne mešajte stare i nove baterije.
- Stare baterije mogu da iscuru i oštete daljinski upravljač. Uvek zamenite baterije što pre je moguće kada oslabe.

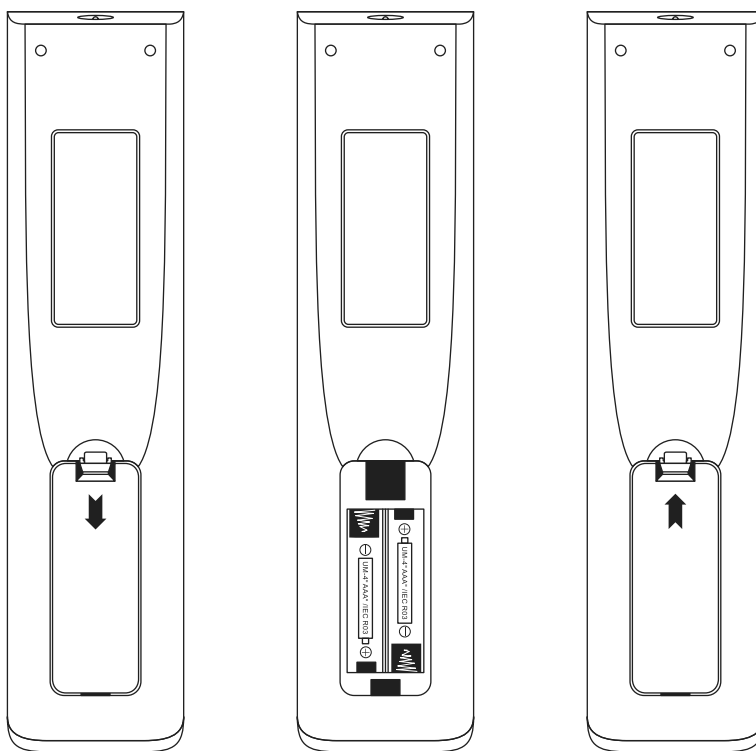

AUTOMATIC PRESET CHANNEL

SIDE PANEL

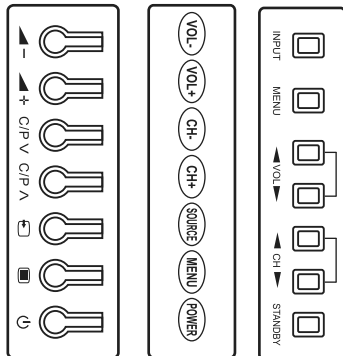

PANEL DALJINSKOG UPRAVLJAČA

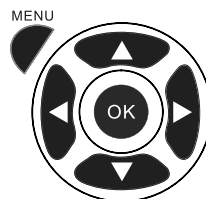

VOL- VOL+ CH- CH+ SOURCE MENU POWER

1. Povežite vašu kablovsku ili Antenu na Antenski priključak.
2. Pritisnite MENU taster na TV ili na daljinskom dok ne vidite 'CHANNEL' meni.
3. Pritisnite ▲ / ▼ tastere na daljinskom da izaberete AUTO Memorisanje.
4. Pritisnite OK ili ► taster na daljinskom da vam prikaže podMENI
5. Pritisnite ▲ / ▼ tastere na daljinskom da izaberete opcije, zatim pritisnite OK taster da počne pretraga i TV će pronaći sve dostupne kanale. U toku automatske pretrage pritiskom na MENU taster izaći će vam poruka na displeju „Sa li želite da prekinete pretragu "tuning Da NE ►", i pritisnite OK taster da napustite auto memorisanje.

Sada ste spremni da gledate TV

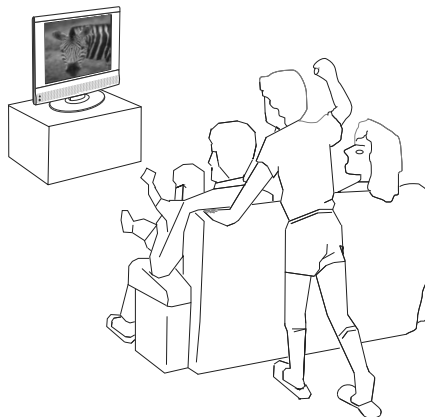

Paljenje i gašenje

1. Povežite TV sa izvor struje pomoću kabela.
2. Kada je indikator crven, TV je u stand by modu.Sada pritisnite POWER taster na daljinskom ili na TV da uključite TV..
3. Da isključite TV u stand by mode samo pritisnite POWER taster na daljinskom ili na TV da isključite TV..

KANALI

Kanal menu

Pritisnite "MENU" i "◀/▶" tastere da izaberete KANAL menu. Pritisnite "T/A" taster da izaberete stavke taster da se izabere the items. Pritisnite OK taster da udjete u pod meni.

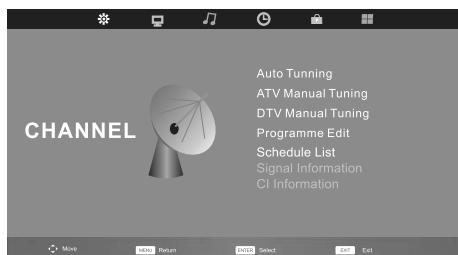

Auto Tuning: Pritisnite [▶] ili [OK] da započne auto pretrafa za oba ATV i DTV kanala.

ATV Manual Tuning: Pritisnite [▶] ili [OK] da započne "ATV Manual Tuning" podmeni.

TREKUTNI CH: pritisnite [◀/▶] da izaberete broj kanala koji želite da memorišete.

Color System: Pritisnite [◀/▶] da promenite color sistem na Auto, SECAM, PAL.

Sound System: Pritisnite [◀/▶] da promenite zvučni system na DK, I, BG,L.

Fine-Tune: pritisnite [◀/▶] da skenirate trenutni program na trenutnoj frkvenciji i da snimate rezltat ručno.

AFC: Podesite Automatsku Kontrolu Frekvencije na "On" ili "Off".

Pretraga: pritisnite [◀/▶] da započnete pretragu.



DTV manualno podešavanje: Pritisnite [▶] ili [OK] da udjete "DTV Manualna pretraga" podmeni.

Pritisnite [◀/▶] da izaberete kanal,zatim pritisnite OK da pretražite programe.

Napomena:Samo kanali sa dovoljno jakim signalom biće pronađeni, Preverite svoju antenu ako nedostaju kanali posle auto pretrage.

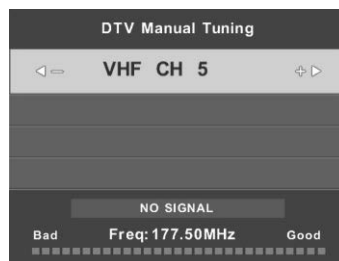

KANAL

Ova opcija ima 5 funkcija

1. Pritisnite Crveni taster da obrišete trenutni kanal.
2. Pritisnite Žuti taster i ▲ / ▼ da pomerite trenutni kanal.
3. Pritisnite Plavi taster da preskočite trenutni kanal.
4. Pritisnite [FAV] da označite trenutni kanal kao omiljeni, biće crveno srce u pozadini izabranog kanala. Ako je trenutni kanal izabran ceć kao omiljeni , pritisnite još jednom i biće podešen kao normalan .

Lista rasporeda

Prikaz liste rasporeda i liste snimaka.

Signal Informacije:

Prikaz informacijej o signalu u DTV modu.

CI Informacije:

Molim kontaktirajte vašeg provajdera da vam obezbedi karticu i modul.

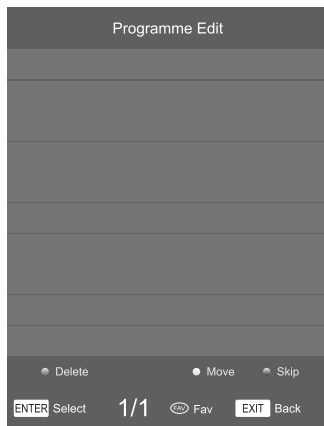

SLIKA

SLIKA

Pritisnite [MENU] za prikaz glavnog menija.

Pritisnite [◀/▶] da izaberete "SLIKA" u glavnom meniju, zatim [OK] da potvrdite.

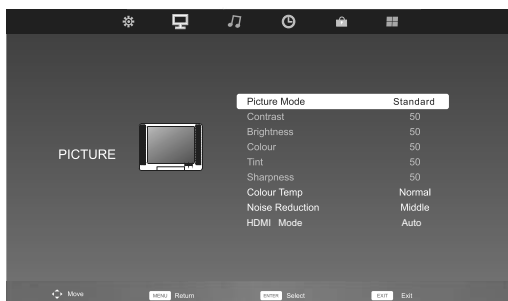

Mod slike: Pritisnite [◀/▶] ili [OK] da uđete u "Picture Mode" podmeni. Pritisnite ▲ / ▼ da promenite mod slike: Dynamic— Standard— Mild — Personal.

Pritisnite [P.MODE] ponajvjajući da promeni mod Slike direktno.

Contrast: Pritisnite [◀/▶] ili [OK] da uđete u podmemni. Pritisnite [◀/▶] to set the picture's contrast intensity.

Brightness: Pritisnite [◀/▶] or [OK] da uđete u podmeni. Pritisnite [◀/▶] da podesite svetlinu slike.

Colour: Pritisnite [◀/▶] ili [OK] da uđete u podmeni. Pritisnite [◀/▶] da podesite jačinu slike.

Tint: Pritisnite [◀/▶] ili [OK] da uđete u podmeni. Pritisnite [◀/▶] da podesite tintu.

Sharpness: Pritisnite [◀/▶] ili [OK] da uđete u podmeni. Pritisnite [◀/▶] da podesite oštrinu slike.

Colour Temp: Pritisnite [◀/▶] ili [OK] da uđete "Colour Temp" podmeni. Pritisnite ▲ / ▼ da promenite toplinu boje Cold — Normal— Warm.

Redukcija šuma: Pritisnite [◀/▶] ili [OK] da uđete u "Noise Reduction" podmeni. Pritisnite ▲ / ▼ da promenite redukciju šuma: Off— Low — Middle — High —Default.

SCREEN

Pritisnite "SOURCE" taster na daljinskom upravljaču da uđete u OSD meni, zatim Pritisnite "▲ / ▼" taster da izaberete "EKRAN". Pritisnite "OK" taster da uđete "EKRAN" mod.

EKRAN (dostupno samo kada je povezan preko SCREEN Only available when connected via EKRAN sa PC) Automatsko podešavanje veličine slike.

Pritisnite "▲ / ▼" taster da izaberete podešavanje slike horizontalno

Pritisnite "OK" taster da uđete u podešavanje slike vertikalno.

Pritisnite "▲ / ▼" da izaberete stavke.

Pritisnite "◀ / ▶" taster da podesite.



SOUND

Mei ZVUKA

Pritisnite [MENU] da prikaže glavni meni.

Pritisnite [◀/▶] da izaberete "zvuk" u glavnom meniju, zatim Pritisnite [OK].

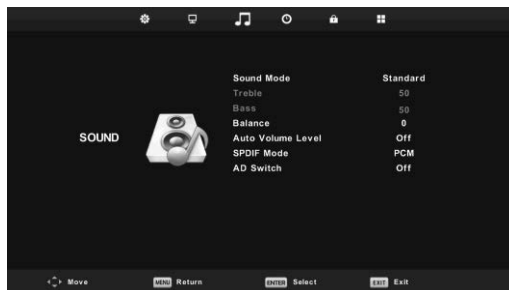

Sound Mode: Pritisnite [◀/▶] ili [OK] da uđete "mod zvuka" podmeni. Pritisnite [▲ / ▼] da promenite mod zvuka: Standard—Music—Movie— Sports— Personal.

Možete da pritisnete [S.MODE] ponajavljući na daljinskom upravljaču da promenite mod zvuka direktno.

Balance: Pritisnite [◀/▶] ili [OK] da uđete u podmeni. Pritisnite [◀/▶] da postavite odgovarajuću vrednost levog i desnog zvučnika .

Auto jačina: Pritisnite [◀/▶] ili [OK] da podesite automasku jačinu na "On" ili "Off".

SPDIF Mode: Pritisnite [◀/▶] ili [OK] da podesite SPDIF mod na "Auto", "Off" ili "PCM".

AD promena (Za DTV samo): Pritisnite [▶] ili [OK] da uđete u podmeni. Pritisnite [◀/▶] audio opis na "On" or "Off" kao i podešavanje nivoa jačine za AD.

TIME

VREME meni

Pritisnite [MENU] da se prikaže glavni meni.

Pritisnite [◀/▶] da se izabere "VREME" U glavnom meniju, zatim pritisnite [OK].



Sat: koristite ◀/▶ tastere da se izabere pozicija, i koristite ▲/▼ da podesite vreme.

Vremenska Zona: Pritisnite [OK] da uđete u podmeni. Pritisnite [▲▼◀▶] da se izabere, Pritisnite [OK]

Sleep Timer: Pritisnite [▶] ili [OK] da uđete u "Sleep Timer"podmeni. Pritisnite [▲/▼] da promenite sleep tajmer sa/na Off, 10Min, 20 Min, 30 Min, 60 Min, 90 Min, 120 Min, 180 Min, 240 Min.

Možete pritisnite [SLEEP] više puta na daljinskom upravljaču da promenite direktno.

Auto Standby: Pritisnite [OK] da uđete u podmeni. Pritisnite [▲/▼] da se izabere Off, 3 H, 4 H, 5 H, Pritisnite [OK]

OSD tajmer: Pritisnite [▶] ili [OK] da uđete u podmeni. Pritisnite [▲/▼] da proeminte OSD tajmer za 5 sekundi, 10 Sekundi, 15 Sekundi, 20 Sekundi, 25 Sekundi, 30 Sekundi.

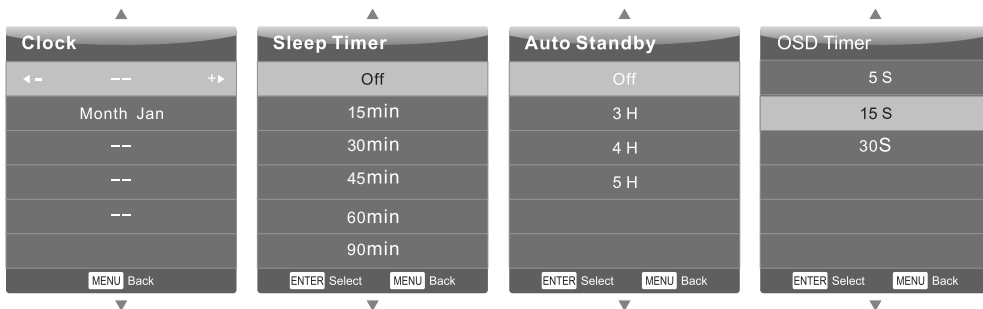

ZAKLJUČAVANJE

ZAKLJUČAVANJE

Pritisnite [MENU] da se prikaže glavni meni.

Pritisnite [▲/▼] da se izabere "LOCK" U glavnom meniju, zatim pritisnite [OK].



Šifra: Unesite početnu šifru "0000" da uđete u MENI funkciju ako hoćeš da promeniš "Lock System" u "On".

Sistem zaključavanja: podesi sistem na "On" ili "Off" koji vam omogućava ili onemogućava dole funkcije.



Podesite šifru: Pritisnite [▶] ili [OK] da uđete u podmeni da podesite novu šifru.

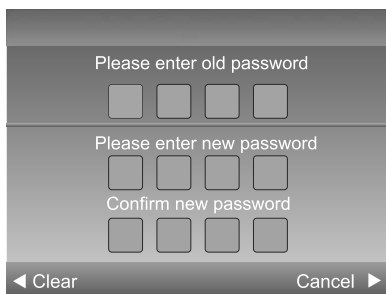

Možete da promenite šifru tako što unesete staru, zatim novu šifru i ponovite novu šifru.

Blokirati program: Pritisnite [OK] da prikaže Blokiraj program meni.

Parental Guidance: Pritisnite [OK] za podmeni, Pritisnite [▲/▼] da se izabere Off, 4,5, 6,7,8,9,10,11,12,13,14, 15,16,17,18. Pritisnite [OK].

Zaključavanje tastature: Pritisnite [OK] da se izabere Off ili On.

PODEŠAVANJE

SETUP menu

Pritisnite [MENU] da se prikaže glavni meni.

Pritisnite [◀/▶] da se izabere "SETUP" U glavnom meniju, zatim pritisnite [OK].



OSD Jezik

Pritisnite **OK** da izaberete ◀ / ▶ , ▼ / ▲ zatim taster da se izabere OSD jezik.

Pritisnite "MENU" za povratak na prethodni meni.

TTX Jezik: Pritisnite [OK] da uđete u podmeni, Pritisnite [▼/▲] da se izabere items. Pritisnite [OK] to oonfirm.

Audio Jezik / Jezik titla: Pritisnite [OK] da uđete u podmeni, Pritisnite [◀▶▼▲]da se izabere stavka Pritisnite [OK].

Za oštećeni sluh (za DTV samo):

Pritisnite [◀/▶] ili [OK] da se podesi za oštećeni sluh "On"ili "Off".

PVR sistm datoteka(za DTV samo):

Pritisnite [▶] ili [OK] da uđete u podmeni,proverite da li je USB povezan .

skala: Pritisnite [OK] da uđete u podmeni, Pritisnite [▼/▲] da se izabere 4:3,16:9, Zoom1, Zoom2, Pritisnite [OK]

Plavi ekran

Pritisnite **OK** taster da se izabere On or Off.

Prva instalacija: Pritisnite [▶] ili [OK] da pokrenete odgovarajuće opcije kao i OSD Jezik i zemlju.

Reset

Ovo će da resetuje sva podešavanja na fabričko. Pritisnite **OK** taster za početak – bićete pitani da potvrdite za početak (vidite sliku desno).

Pritisnite " ◀ / ▶ " taster da se izabere Yes or No.

Pritisnite "MENU" ili "EXIT" taster za izlazak

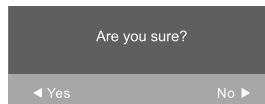

Software Update(USB): Pritisnite [▼/▲] da se izabere Software Update. Pritisnite [OK]

USB

Pritisnite "SOURCE" taster da izađe SOURCE meni.

Pritisnite "[▲/▼]" taster da se izabere "Media" i Pritisnite "OK" da uđete u sledeći meni:

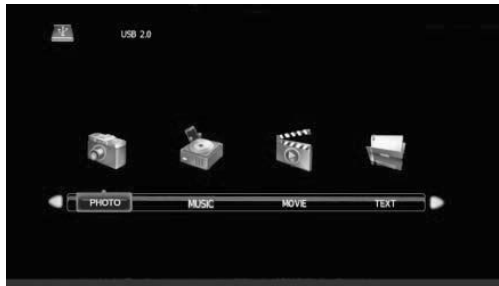

Pritisnite "◀ / ▶" taster da se izabere između "PHOTO", "MUSIC", "MOVIE" i "TEXT" ikone. Pritisnite "OK" taster da potvrdite i aktivirate sledeći meni:



PHOTO

1. Pritisnite "◀ / ▶" Taster da se izabere "PHOTO".
 2. Pritisnite "OK" taster da uđete u disk meni .
 3. Pritisnite "◀ / ▶" taster da se izabere disk uđete u podmeni.
 4. Pritisnite taster da obeležite fajlove. Pritisnite OK da se izabere fajlove (označeno kvačicom) za selektivnu reprodukciju (vidite6 ispod). Pritisnite crveni taster, ući ćete u podmeni da izbrišete fajl.
 5. Pritisnite OK taster da da pregledate fajl kao na slici ispod:
 6. Pritisnite "PLAY" taster da pustite slajd show(od izabranih fajlova);
- Ako ni jedan fajl nije izabran reprodukuć se svi fajlovi), Pritisnite "OK" da se aktivira meni..

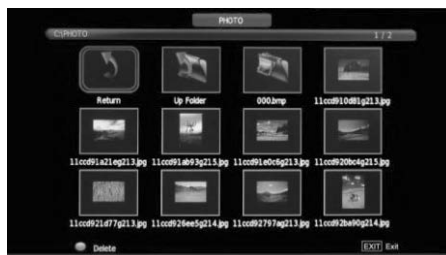

USB

Pauza

Pritisnite "PAUSE" taster da pauzirate slideshow.

Play

Pritisnite "PLAY" taster reprodukujete izabrane fajlove.

Stop

Pritisnite "STOP" taster za zaustavljanje i reprodukciju.

Next/Prev.

Pritisnite "NEXT" ili "PREV." taster da preskočite pregled izabranog fajla.

Exit

Pritisnite "EXIT" taster za exit.



MUZIKA

1. Pritisnite ◀ / ▶ taster da se izabere "MUZIKA".
2. Uđite u interfejs MIZIKA, Pritisnite ▶ taster to za pregled muzike kao što je prikazano ispod:



3. Press "PLAY" button into music player and playing the selected music, as shown below:

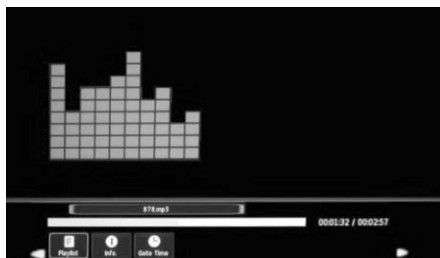
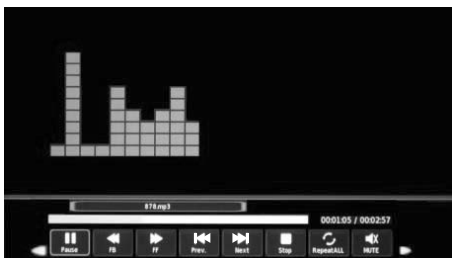

PAUSE

Izaberite "PAUSE" da pauzirate muziku.

PLAY

Izaberite "PLAY" da pustite muziku.

FB

Izaberite "FB" da vratite 2X, 4X, 8X and 16X mod.

FF

Izaberite "FF" da ubrzate 2X, 4X, 8X and 16X mod.

PREV.

Izaberite "PREV." Da vratite na prethodni fajl.

Izaberite "NEXT" da pređete ne sledeći fajl.

NEXT

Izaberite "STOP" da zaustavite i vratite se.

STOP

Izaberite 'O' da se ponovi reprodukcija (O ponoviti 1, Oponovite sve, O ništa ne ponovite). I

RepeatALL

MUTE

Izaberite "MUTE" da ugasite zvuk.

USB

Plavlist Izaberite "Playlist" da se prikaže playlista.

Info- Izaberite "Info" da se prikažu informacije o fajlu.

Goto Time Izaberite "Goto Time" da podesite vreme

MOVIE

1. Pritisnite "◀ / ▶" taster da se izabere "MOVIE"
2. Uđite u movie interfejs. Pritisnite "▲▼◀▶" taster pregled fajlova kao na slici ispod.:



3. Pritisnite "PLAY" taster reprodukujete film. Pritisnite OK taster za prikaz menija.
Pritisnite "PLAY" taster još jedno za prikaz u punom ekranu.
Pritisnite "PAUSE" taster pauzirate film.
Pritisnite "PREV." ili "NEXT" taster preskočite unapred ili unazad fajl. Pritisnite "FB" ili "FF" taster da premotate nazad ili napred Pritisnite "STOP" ili "EXIT" taster da izđete.

TEXT

1. Pritisnite "◀ / ▶" taster da se izabere "TEXT"(za pregled tekstualnih dokumenata na USB-u).
2. Uđite u Text interfejs, Pritisnite"▲▼◀▶"taster za pregled fajlova kao što je prikazano na slici:



3. Pritisnite "PLAY" taster da otvorite fajl , Pritisnite OK taster da prikazete meni. Kao na slici.:

Izaberite "Prev Page" za pregle prethodne stranice.

Izaberite "Next Page" za pregled sledeće stranice.

Izaberite "STOP" za povratak.

Izaberite "Music" da slušate muziku dok čitate.









1. Read these instructions.
2. Keep these instructions.
3. Heed all warnings.
4. Follow all instructions.
5. Do not use this apparatus near water.
6. Clean only with dry cloth.



MENU OPERATION

MULTIMEDIA

Lista

	Stop Playback
	Smerne strelice
INFO 	Prikaži detalje
	Reprodukcija
	Pauza
	Brzo premotavanje unazad
	Brzo premotavanje unapred
	Prethodni
	Sledeći
RED	Briši
OK	Potvrdi
EXIT	Izlaz
SUBTITLE	Kada gledate film da uključite ili isključite titl

Sleđći su funkcijski interfejsi za PHOTO, MUSIC, MOVIE i TEXT. Za njihove funkcije detaljnije pogledajte na 19 stranici

PHOTO



MUSIC



MOVIE

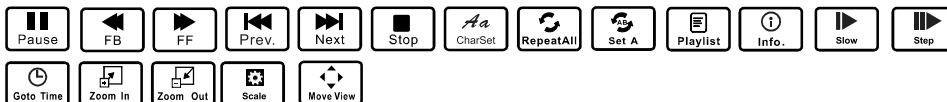

TEXT



VODIČ ZA REŠAVANJE PROBLEMA

Mnogi prividni kvarovi su prouzrokovani nesporazumima prilikom redovne upotrebe i uglavnom su jednostavni za otkloniti. Ukoliko imate poteškoća sa rukovanjem, prvo pogledajte sledeću listu uobičajenih grešaka i njihovih rešenja.

Ako problem ne rešite, isključite uređaj i pozovite svog servisera.

SYMPTOM METHODS OF CHECKING OR ADJUSTING

Nema slike ili zvukaNo picture or sound Proverite da li je naponski kabal ispravno priključen u utičnicu.

Slika je normalna ali bez zvuka

Proverite da nije slučajno zvuk podešen na nečujno (MUTE) Ukoliko jeste pojačajte zvuk .

Daljinski upravljač ne radi

Proverite da li je TV uključen.

Proverite da li su baterije ispravno postavljene.

Uverite se da infracrveni odašiljač na daljinskom ili TV nije izložen jakoj svetlosti ili da nije blokiran na bilo koji način.

Ne primete nikakav any TV signal

Proverite da li je SOURCE prekišač postavljen na TV. Proverite i podešavanje za lokaciju i povezanost. Pokušajte da ponovno skenirate kanale i proverite metod pretrage.

Bez signala programa sa spoljašnjeg izvora Proverite da li je taster SOURCE podešen na ispravnu poziciju za prijem signala.

Problem sa kontrastom i osvetljenjem. Napravite potrebene i željene izmene.

Slab contrast i blede boje na svim kanalima Proverite podešavanje za lokaciju prijema signala.

Linije ili tačke po celom ekranu Drugi električni uređaji mogu da izazovu smetnje. Sklonite ih od televizora.

Sneg na ekranu Proverite lokacijska podešavanja, kratak spoj, prekinuta konekcija ili bilo koja vidljiva oštećenja.

Dupla slika ili zamagljenost

Proverite podešavanja za lokaciju i uopšte položaj antene ili uređaja. Jak vetar može da izazove takve problem. Visoke zgrade ili planine takođe. Malo podešavanje antene može u mnogo čemu da popravi sliku..

Napomena: spoljna ili krovna antena treba da bude postavljena od strane ovlašćenog osoblja.

SPECIFIKACIJA

Aspect Ratio	16 : 9
System	PAL/SECAM BG/DK/I, DVB-T/T2+C, NTSC Playback
Imendansa	75 Ω (Unbalance)
PRIJEM TV Band	All Channels Receiveable
Napon	100-240V~ 50/60Hz

Daljinski upravljač

Karakteristike: Daljinski upravljač sa svim funkcijama **radiju rada:** 8 metara

Napajanje: DC 3V (dve baterije, veličine AAA, preporuka da koristite alkalne)