



HDMI[®]
HIGH-DEFINITION MULTIMEDIA INTERFACE

UPUTSTVO ZA UPOTREBU

LED TELEVIZORI Model:39DLE172

Hvala Vam što ste kupili ovaj uređaj.

FOX LED televizori prepoznaju se po odličnim tehničkim karakteristikama, kao i modernom, funkcionalnom i elegantnom dizajnu. Osim toga konstantna unapređenja u vidu postprodajne podrške, izuzetno efikasna i rasprostranjena servisna mreža čine da se ponosni vlasnici FOX televizora mogu osećati sigurno.

Napravili ste pravi izbor.

U nastavku slede uputstva za upotrebu. Nisu komplikovana, ali ih se morate pridržavati.

EN

SR

Table Of Contents

Preparations Guide	
Safety Information.....	2
Important Safety Precautions.....	3
Installed And Connected TV	
TV Bracket assemble.....	4
TV Buttons And Terminal Interface.....	5
External device connect ion diagram.....	6
Install And Connect TV.....	7
TV St and installation Instructions.....	7
TV Menu	
First Time Installation.....	8
Channel Menu.....	10
Picture Menu.....	15
Sound Menu.....	17
Time Menu.....	18
Lock Menu.....	20
Hotel Mode.....	22
Setup Menu.....	23
PC Menu	
Screen Menu.....	26
Media Menu	
Media Operation.....	27
Photo Menu.....	28
Music Menu.....	29
Movie Menu.....	30
Text Menu.....	31
Other Information	
Help.....	32
Specifications.....	33
Remote Controller.....	34

This user manual for reference only

Safety Information

CAUTION

**RISK OF ELECTRIC SHOCK
DO NOT OPEN**

High voltages are used in the operation of this product. to reduce the risk of electric shock, do not remove cover of the cabinet, refer servicing to qualified service personal

If the TV any changes or coarse adjustment, electric shocks to be hurt, do not attempt to open a machine-maintenance, customer contact centres needed overhaul.



The exclamation point within an equilateral triangle is intended to alert the user to the presence of important operating in the literature accompanying the appliance.

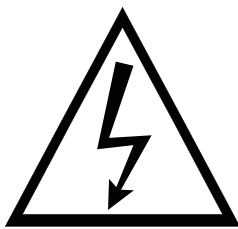

Warning
The lightning flash with arrowhead symbol within an equilateral triangle, is intended to alert the user to the presence of uninsulated dangerous voltage within the products enclosure that may be of sufficient magnitude to constitute a risk of electric shock to persons.

Important Safety Precautions

- 1) Read these instructions.
- 2) Keep these instructions.
- 3) Heed all warnings.
- 4) Follow all instructions.
- 5) Do not use this apparatus near water.
- 6) Clean only with dry cloth.
- 7) Do not block any ventilation openings. Install in accordance with the manufacturer's instructions.
- 8) Do not install near any heat sources such as radiators, heat registers, stoves, or other apparatus (including amplifiers) that produce heat.
- 9) Do not defeat the safety purpose of the polarized or grounding-type plug. A polarized plug has two blades with one wider than the other. A grounding type plug has two blades and a third grounding prong. The wide blade or the third prong are provided for your safety, If the provided plug does not fit into your outlet, consult an electrician for replacement of the obsolete outlet.
- 10) Protect the power cord from being walked on or pinched particularly at Plugs, convenience receptacles, and the point where they exit from the apparatus.
- 11) Only use attachments /accessories specified by the manufacturer.
- 12) Use only with the cart, stand, tripod, bracket, or table specified by the manufacturer, or sold with the apparatus. When a cart is used caution when moving the cart/apparatus combination to avoid injury tip-over.



- 13) Unplug this apparatus during lightning storms or when unused for long periods of time.

Caution:

- 14) To reduce the risk of fire or electric shock, do not expose this apparatus to rain or moisture.
- 15) The mains plug is used as disconnect device, the disconnect device shall remain readily operable.
- 16) The socket-out shall be installed near the equipment and shall be easily accessible.
- 17) This product should never be placed in a built-in installation such as a bookcase or rack unless proper ventilation is provided or the manufacture's instructions have been adhered to.
- 18) The apparatus shall not be exposed to dripping or splashing and that no objects filled with liquid, such as vases, shall be placed on the apparatus.
- 19) Do not place any sources of danger on the apparatus (e.g. liquid filled objects, lighted candles).
- 20) Wall or Ceiling Mounting - The appliance should be mounted to a wall or ceiling only as recommended by the manufacturer.
- 21)  Never place the TV, remote control or batteries near naked flames or other heat sources, including direct sunlight. To prevent the spread of fire, keep candles or other flames away from the TV, remote control and batteries at all times.
- 22) The USB terminal should be loaded with 0.5 A under normal operation.

These servicing instructions are for use by qualified service personnel only. To reduce the risk of electric shock do not perform any servicing other than that contained in the operating instructions.

unless you are qualified to do so.

- 23) The battery shall not be exposed to excessive heat such as sunshine, fire or the like.
- 24) This equipment is a Class II or double insulated electrical appliance. It has been designed in such a way that it does not require a safety connection to electrical earth
- 25) The maximum using environment temperature is 45 degrees.
The Maximum using altitude is 2000 meters

TV Bracket assemble

Fix the TV on the wall

1. First, put the TV on the table smoothly and put some soft cloth on the table to avoid scratching the screen.
2. Use the screw driver to take off the screws which are fixed on the bottom stand (the direction of the arrow, refer to the photo1). And take off the bottom stand (please take off the screws and bottom stand carefully).
3. Make one bracket which can fix on the wall according to the size of arrow direction of photo2 and photo3.
4. Drill four holes properly on the wall (the size only for reference) and put into four screws. (optional parts) Drill four holes properly on the wall (the size only for reference) and put into four screws. (optional parts)
5. according to the step 4, use the screwdriver to lock the screw on the back of the TV. then hang the TV on the wall.

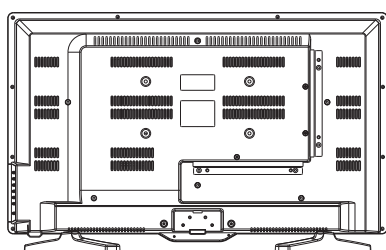

1

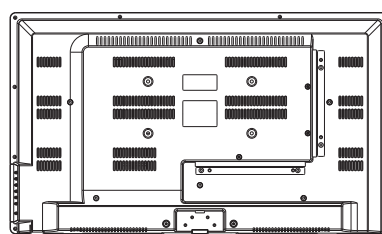

2

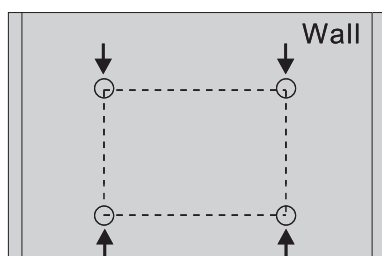

3

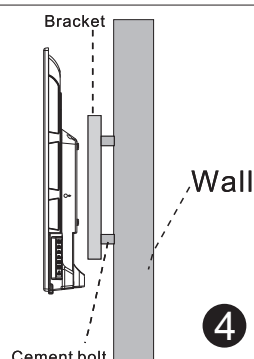

4

Note:

1. The bracket fixed on the wall is optional part.
2. when you assemble the TV, there should be no other articles on the around and front and please keep the distance from other articles.
3. When assemble the TV, please ask the career man to fix in order to avoid the danger.
4. The fixing picture is only for reference.
5. Please follow the use manual about bracket assemble to fix the TV.
6. Attach the mounting bracket from the VESA compatible wall mounting kit.

NOTE:

IF YOUR PROGRAM ON TV WILL BE INCLUDED BY CABLE TELEVISIONS,
PLEASE CHECK YOUR EARNING AND POTENTIAL EVALUATION ON THE CABLE OF YOUR
CABLE OPERATOR.
FOR THESE INFORMATION CONTACT YOUR CABLE OPERATOR.

TV Buttons And Terminal Interface

TV Buttons

Note: The following is only functional schematic, And the actual position and arrangement of different models may be different.

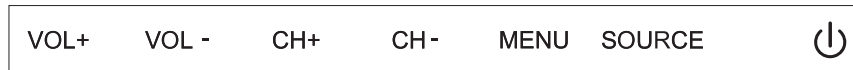

: Turn ON/OFF Power.

SOURCE: External Signal Input Selection.

MENU: Display Main MENU And Confirm MENU Item Selection.

CH+/-: Selecting Channel.

VOL+/-: Adjusting Volume.

Terminal Interface

Note: The following are the various terminal interface, the actual position and arrangement, the number of different models may be different.

	AV input External AV Signal Input		EARPHONE output When earphones are plugged in, speakers are disabled
	Y Pb Pr input Connect to the composite terminal of your DVD/VCR		USB input Connect a USB device here to play its media files or to record programs via the PVR function.
	HDMI input Digital signal input from HDMI video connector.		COAXIAL Connect the SPDIF receiver.
	ANT 75 Connect the antennal/cadle tv input (75/VHF/UHF)		PC AUDIO INPUT VGA input and audio input when VGA input
	VGA input PC analog signal input		CI SLOT The card reader input CI (common interface) this requires CAM (conditional access module) used for pay TV.

External device connection diagram

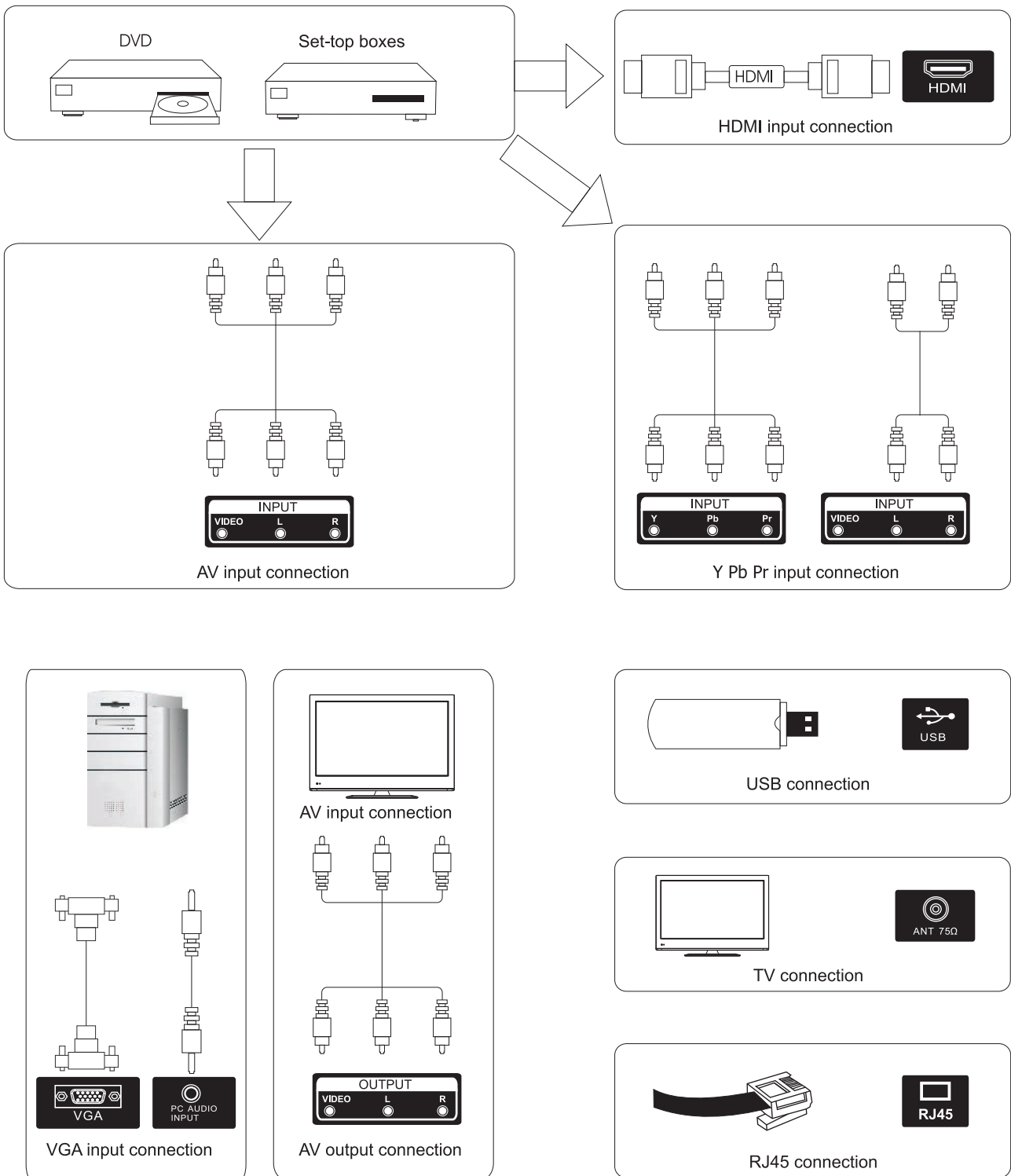

Install And Connect TV

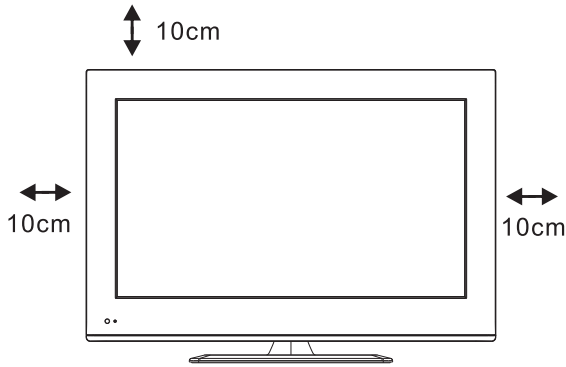

Set your TV

To put your TV in a firm place which can bear the weight of the TV.

To avoid danger, please don't expose the TV near water or heating place (such as light, candle, heating machine), do not block the ventilation at the back of TV.

Connect antenna and power

1. Connect the antenna cable to the antenna socket on the back of the TV.
2. To plug the power cord of TV.

Turn on TV

3. Press the power button of the TV the indication light will turn to green. if it is on standby mode (the light is red), press the power button on the remote control to turn on the TV.

Note:

Picture for reference purposes only.

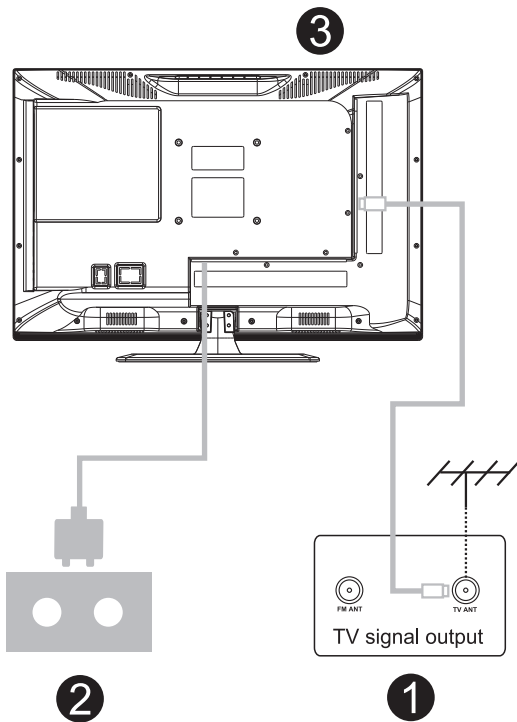

TV Stand Installation Instructions

1. Open the carton and remove the TV and scattered accessories and base (some models without base).
2. To avoid the injury of the TV, covered with a soft mattress, put it on the table, face down on a soft mattress, the base of the neck is fixed on the TV with screws.
3. Screw the base and connected to the TV.
4. The installation is complete.

Note:

Picture for reference purposes only.

Please prevail in kind

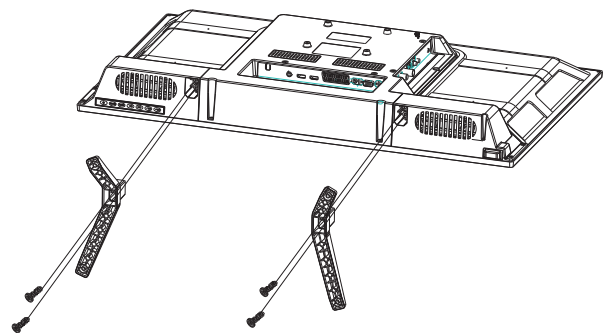

First Time Installation

Connect an RF cable from the Tv's input called "RF-In" and to your TV Aerial socket.

Select Language

Press ◀ / ▶ button to select the language to be used for menus and message.

Select Country

Press ▼ / ▲ button to highlight country menu.

Press ◀ / ▶ button to select the country you want to.

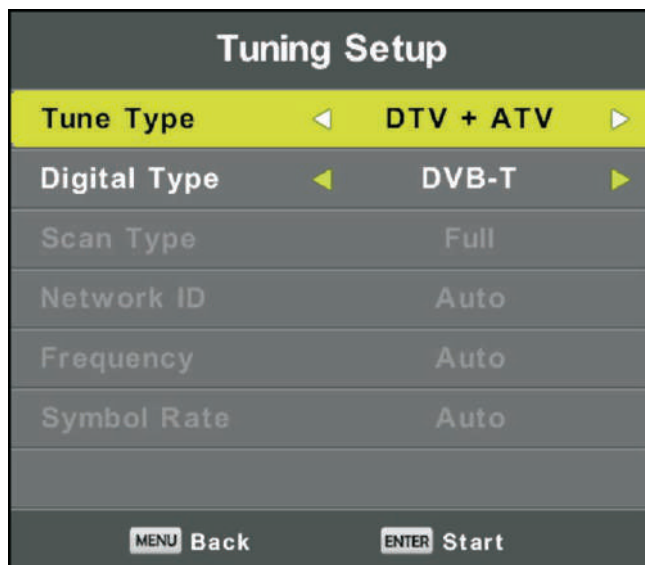
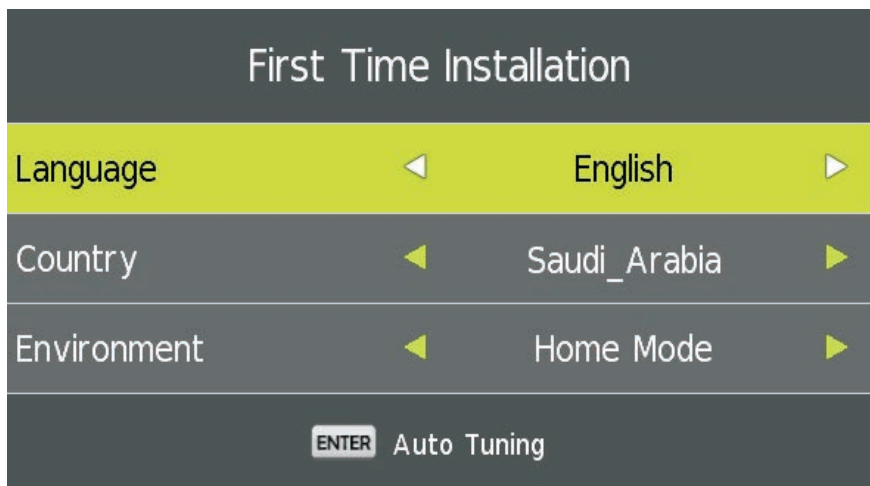

Main Menu Operation

Channel Menu

Press **MENU** button to display the main menu.

Press **◀/▶** button to select **CHANNEL** in the main menu.



1. Press **▼/▲** button to select the option that you want to adjust in the **CHANNEL** menu.
2. Press **Enter** button to adjust.
3. After finishing your adjustment, Press **Enter** button to save and return to the previous menu.

Auto Tuning

Press **▼/▲** button to select Auto Tuning, then press **Enter/▶** button to enter.

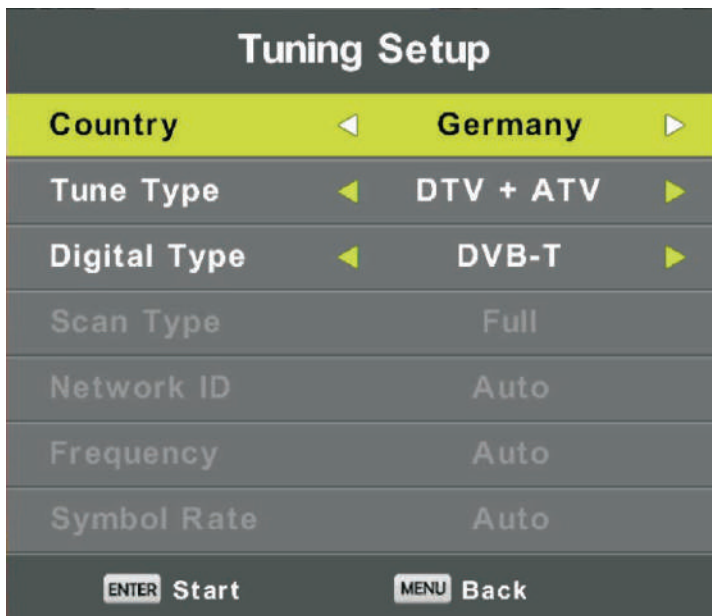

DTV Manual Tuning

Press **▼/▲** button to select DTV Manual Tuning, then press **Enter** button to enter sub-menu.
Press **◀/▶** button to select channel, then press **Enter** button to search program.

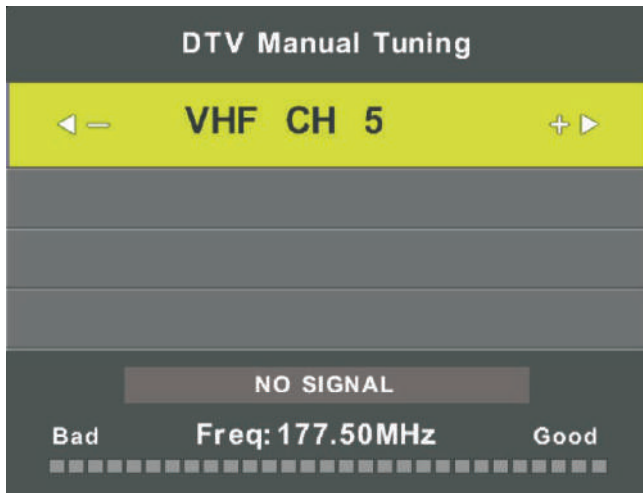

Program Edit

Press **▼/▲** button to select Program Edit, then press **Enter** button to enter sub-menu.



The three colored key is the shortcut key for programming the channel.

First press **▼/▲** to highlight the channel you want to select, then:

Press the **Red** button to delete the program in the list.

Press the **Yellow** button to move the channel in favorite list.

Press the **Blue** button to skip the selected channel.

Press Fav button to add or remote the channel to your favorite list.
(Your TV set will skip the channel automatically when using CH+/- to view the channels.)

Schedule List

Press ▼/▲ button to select Schedule List, then press **Enter** button to enter sub-menu. It is available in source.

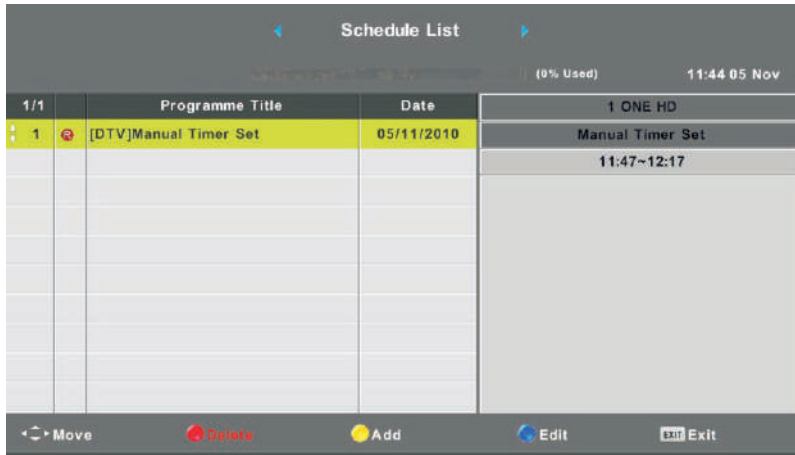

Press the **YELLOW** button to enter the interface below.

When the time appointment is conflict , it will produce a warning message.

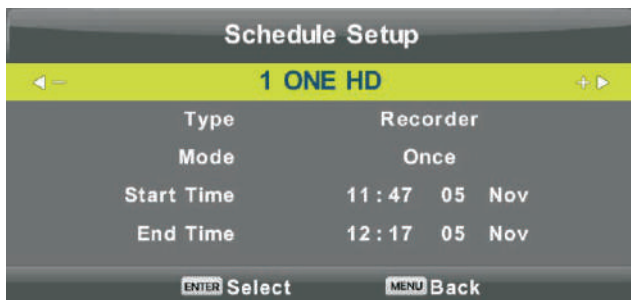

Signal Information

Press ▼ / ▲ button to select **Signal Information**, press the **Enter** button to see the detail information about the signal. Only available when there is signal in DTV.



CI Information (Need to support the CI function)

Press ▼/ ▲button to select CI Information, then press the Enter button to display detail if you has inserted the CI card

The CHANNEL List in Satellite Source.(Need to support the DVB-S2 function)



Auto Tuning

Press ▼ / ▲ button to select Auto Tuning, then press **Enter/▶** button to enter.

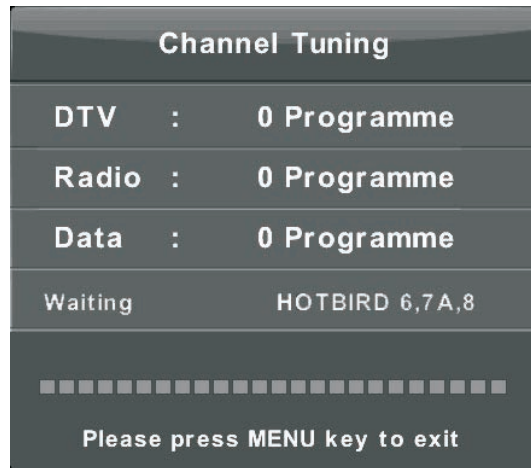
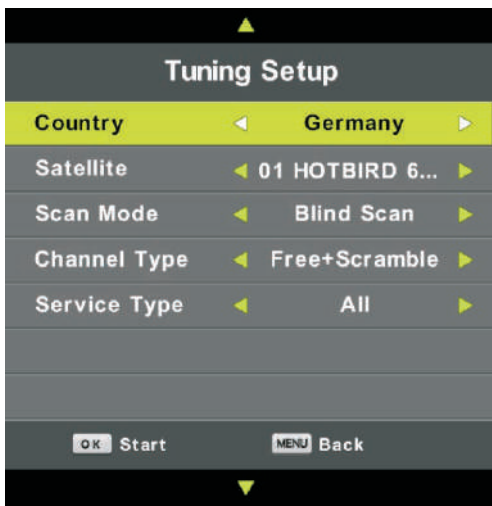

Dish Setup

Press ▼ / ▲ button to select Dish Setup, then press **Enter/▶** button to enter.



Picture Menu

Press **MENU** button to display the main menu.
Press **◀/▶** button to select **PICTURE** in the main menu.

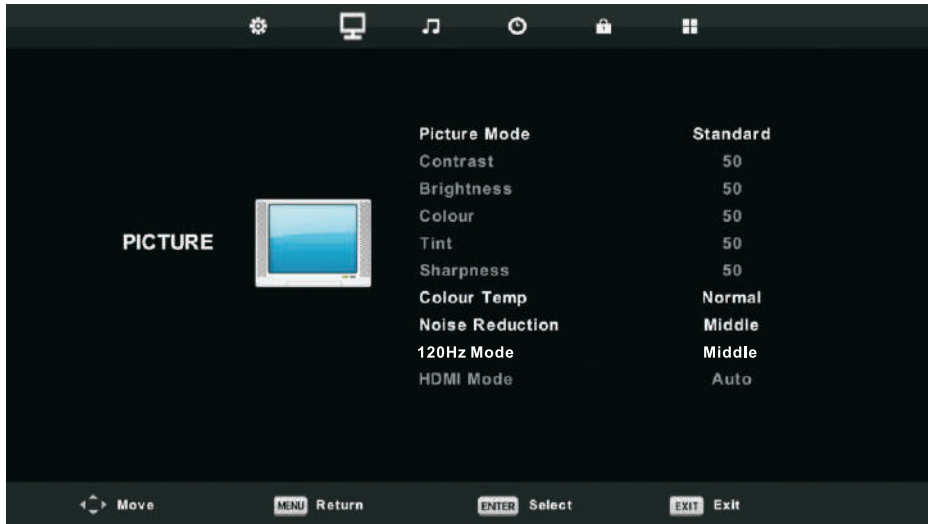

Note: 120Hz MODE Function only supported with UHD TV

1. Press **▼ / ▲** button to select the option that you want to adjust in the **PICTURE** menu.
2. Press **OK** button to adjust.
3. After finishing your adjustment, Press **MENU** button to save and return back to the previous menu.

Picture Mode

Press **▼ / ▲** button to select Picture Mode, then press **OK** button to enter sub-menu.
You can change the value of contrast, brightness, color, sharpness and tint when the picture is in **Personal** mode.

TIPS: You can press PMODE button to change the Picture Mode directly.

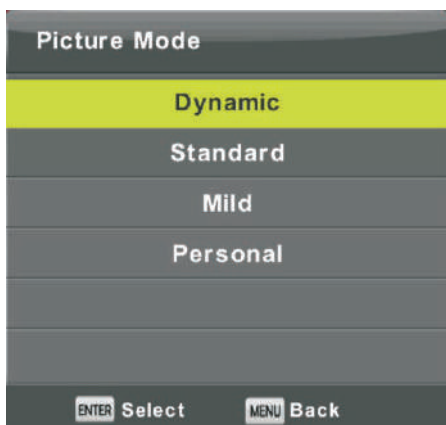

Contrast/ Brightness/ Color/ Tint / Sharpness

Press **▼ / ▲** button to select option, then press **ENTER/ ▶** button to adjust.

- Contrast** Adjust the highlight intensity of the picture, but the shadow of the picture is invariable.
- Brightness** Adjust the optical fiber output of the entire picture, it will effect the dark region of the picture.
- Color** Adjust the saturation of the color based on your own like.
- Tint** Use in compensating color changed with the transmission in the NTSC code.
- Sharpness** Aadjust the peaking in the detail of the picture.

Color Temp



Change the overall color cast of the picture.

Press ▼ / ▲ button to select Color Temperature , then press **OK** button to enter sub-menu.

Press ◀ / ▶ button to select. (Available Picture mode: Cool, Medium, Warm). You can change the value of red, green and blue when the color temperature is in **User** mode.

Cold Increase the blue tone for the white.

Normal Increase the sex-linked colors for the white.

Warm Increase the red color for the white.

Noise Reduction



To filter out and reduces the image noise and improve picture quality.

Press ▼ / ▲ button to select Noise Reduction , then press **OK** button to enter sub-menu.

Off Select to turn off video noise detection.

Low Detect and reduce low video noise.

Middle Detect and reduce moderate video noise.

High Detect and reduce enhanced video noise.

Default Set as Default.

120Hz MODE (Only with UHD TV)



Adjust the motion compensation.

Higher setting may improve the motion performance when watching sports or playing games.

Press ◀ / ▶ button to select (Off/Low/Medium/High)

HDMI Mode



Press ▼ / ▲ button to select HDMI Mode, then press **OK** button to enter sub-menu.

Press ◀ / ▶ button to select . (Available Picture mode; Auto, Video, PC).

Sound Menu

Press **MENU** button to display the main menu.
 Press ◀/▶ button to select **SOUND** in the main menu.

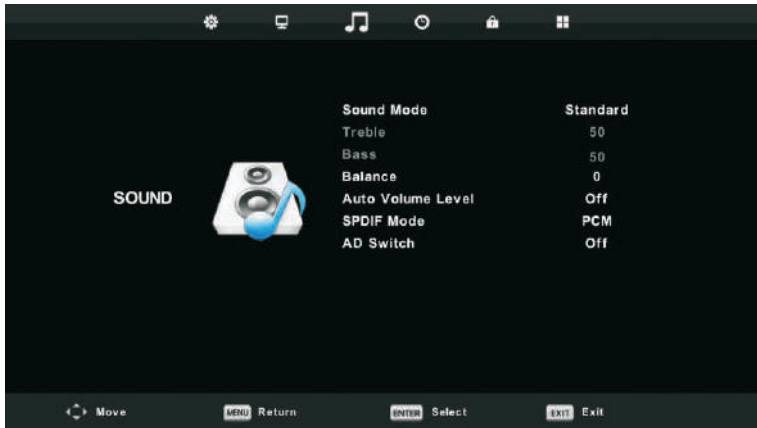

1. Press ▼/▲ button to select the option that you want to adjust in the **SOUND** menu.
2. Press **Enter** button to adjust.
3. After finishing your adjustment, Press **Enter** button to save and return to the previous menu.

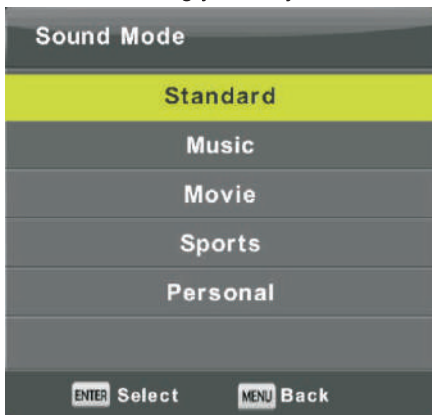

Sound Mode

Press ▼ / ▲ button to select Sound Mode, then press **Enter** button to enter sub-menu. Press ▼/▲ button to select.

You can change the value of Treble and Bass when the sound is in Personal mode.

TIPS: You can press **SMODE** button on the remote control to change the Sound Mode directly.

Standard	Produces a balanced sound in all environments.
Music	Preserves the original sound. Good for musical programs.
Movie	Enhances treble and bass for a rich sound experience.
Sports	Enhances vocals for sports.
Personal	Select to customize picture settings.

Note: The treble and bass are only available in **User** mode, you can adjust them as you like.

Balance

Press ▼/▲ button to select option, Press ◀/▶ button to adjust.

Auto Volume level

Press ▼/▲ button to select Auto Volume Level, then press ◀/▶ button to select On or Off.

SPDIF Mode

Press ▼/▲ button to select SPDIF Mode, then press ◀/▶ button to select Off / PCM / Auto.

AD Switch

Press ▼ / ▲ button to select AD Switch, then press ◀/▶ button to select On or Off.
 Amblyopia function for the blind, the tracks will be mixed describe the current screen.
 It need codestream to support.

NOTE:

Balance: This item can adjust the speaker's output, it enables you to listen to best at your position.

Auto Volume: This item is used for reducing the difference between channel and program's volume automatically.

Time Menu

Press **MENU** button to display the main menu.
Press **◀/▶** button to select **TIME** in the main menu.



1. Press **▼/▲** button to select the option that you want to adjust in the **TIME** menu.
2. Press **Enter** button to adjust.
3. After finishing your adjustment, Press **Enter** button to save and return to the previous menu.

Time Zone

Press **▼ / ▲** button to select Time Zone, then press **Enter** button to enter sub-menu.

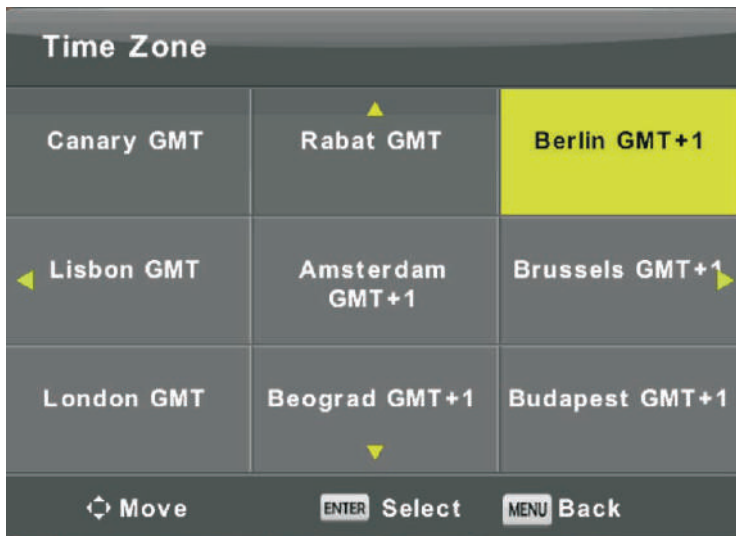

Press **▼ / ▲ / ◀ / ▶** button to select time zone.

Sleep Timer

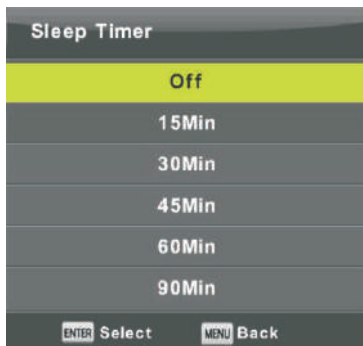

Press **▼/▲** button to select Sleep Timer, then press **Enter** button to enter sub-menu.

Press **▼/▲** button to select.
(Available options are: Off, 10min, 20min, 30min, 60min, 90min, 120min, 180min, 240min).

Auto Standby

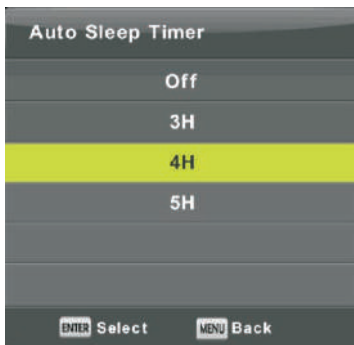

Press ▼/▲ button to select Auto Standby, then press **Enter** button to enter sub-menu.

Press ▼/▲ button to select.

Tips: The remote control does not make any operation in the hypothesis time, it will close down automatically. If you do any operation, it will reset the time.

OSD Timer



Press ▼/▲ button to select OSD Timer, then press **Enter** button to enter sub-menu.

Press ◀/▶ button to select.

Lock Menu

Press **MENU** button to display the main menu.
Press **◀/▶** button to select **Lock** in the main menu.



1. Press **▼ / ▲** button to select the option that you want to adjust in the **LOCK SYSTEM** menu.
2. Press **Enter/◀/▶** button to adjust.
3. After finishing your adjustment, Press **MENU** button to return back to the previous menu

Lock System

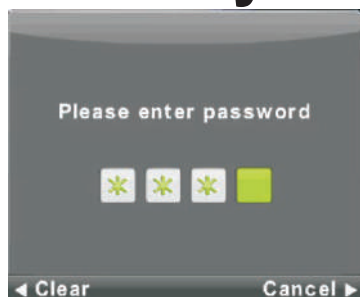

Press **▼ / ▲** button to select Lock System,
then press **Enter** button to make the following 3 options valid.

Default password is 0000, and if forget what you set,
please call the service center.

Set Password

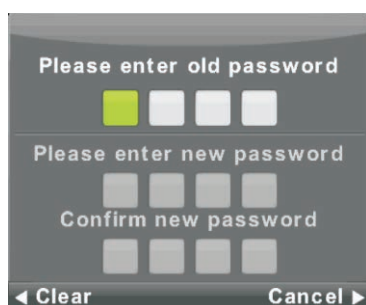

Press **▼ / ▲** button to select Set Password,
then press **Enter** button to enter sub-menu to set new password.

Channel Lock



Press ▼ / ▲ button to select Channel Lock then press **Enter** button to enter sub-menu to select. Press **Green** button to lock or unlock the channel.

Parental Guidance

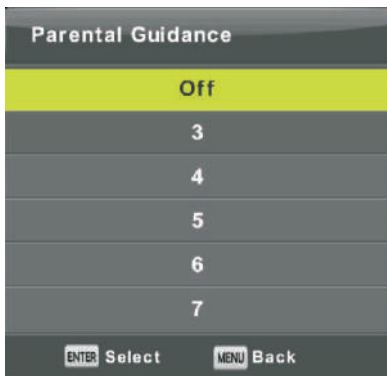

Press ▼ / ▲ button to select Parental Guidance, then press **Enter** button to enter sub-menu to select the number of age which is suitable for your children.

Key Lock

Press ▼ / ▲ button to select Key Lock, then press ◀/▶ button to select Off or On. When Key Lock's statue is on, you can't use the Key panel button.

Hotel Mode(Need support the Hotel Mode)

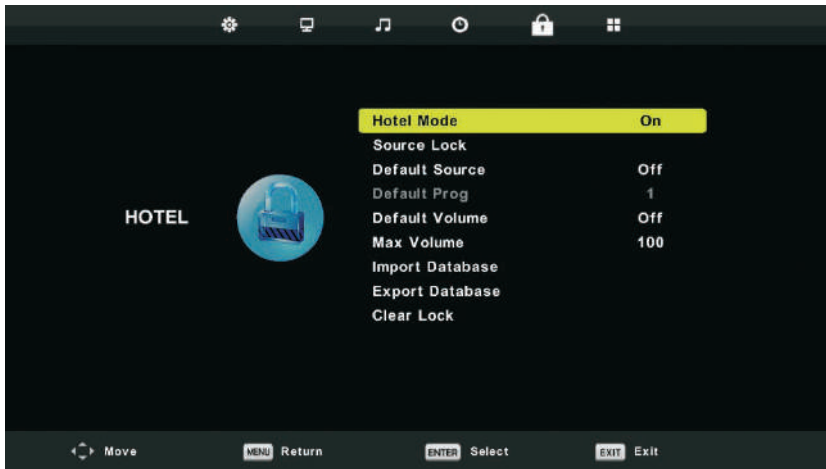

1. Press ▼ / ▲ button on the remote control to select hotel mode in the **Lock** menu.
2. Press **Enter** button on the remote control to enter the sub-menu.
3. After finishing your adjustment, Press **MENU** button to save and return back to the previous menu.

Hotel Mode

Press ▼ / ▲ button to select Hotel Mode, then press ◀/▶ button to select on or off.

Source Lock

Press ▼ / ▲ button to select Source Locke, then press **Enter** button to enter sub-menu to select.

Default Source

Press ▼ / ▲ button to select Default Source, then press **Enter** button to enter sub-menu to select.

Default Prog

Press ▼ / ▲ button to select Default Prog, then press ◀/▶ button to adjust.

It is available when the default source is TV.

Max Volume

Press ▼ / ▲ button to select Max Volume, then press ◀/▶ button to adjust.

Clear Lock

Press ▼ / ▲ button to select Clear Lock, then press **Enter** button to clear the setting you have done before.

Setup Menu

Press **MENU** button to display the main menu.
Press **◀/▶** button to select **SETUP** in the main menu.



1. Press **▼/▲** button to select the option that you want to adjust in the **SETUP** menu.
2. Press **Enter** button to adjust.
3. After finishing your adjustment, Press **Enter** button to save and return to the previous menu.

OSD Language

Select an OSD menu language can be displayed. Default English is selected as menu language.

Press **▼ / ▲ / ◀ / ▶** button to select Menu Language.

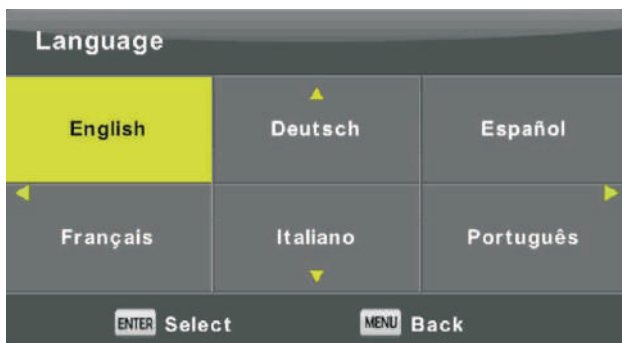

TT Language

Press **▼ / ▲** button to select TT Language, then press **Enter** button to enter sub-menu.
Press **▼ / ▲ / ◀ / ▶** button to select TT language.



Audio Languages

Press ▼ / ▲ button to select Audio Languages, then press **Enter** button to enter sub-menu.
Press ◀ / ▶ button to select the primary of Audio Languages.
Press ▼ / ▲ / ◀ / ▶ button to select the Audio Languages.



Subtitle Language

Press ▼ / ▲ button to select Subtitle Language, then press **Enter** button to enter sub-menu.
Press ◀ / ▶ button to select the primary of Subtitle Language.
Press ▼ / ▲ / ◀ / ▶ button to select the Subtitle Language.



Hearing Impaired

Press ▼ / ▲ button to select Hearing Impaired, then press **Enter** button to select On or Off.

PVR File System

Press ▼ / ▲ button to select PVR File System, then press **Enter** button to enter sub-menu.
Press ▼ / ▲ button to select Check PVR File System,
then press **Enter** button to enter. Then it will check the USB speed.



Aspect Ratio

Press ▼ / ▲ button to select Aspect Ratio, then press **Enter** button to enter sub-menu.

Press ▼ / ▲ button to select aspect ratio. (Available options are: Auto, 4:3, 16:9, Zoom1, Zoom2).



Blue Screen

Press ▼ / ▲ button to select Blue Screen, then press **Enter** button to select On or Off.

First Time Installation

Press ▼ / ▲ button to select First time installation, then press **Enter** button to enter.

Reset

Press ▼ / ▲ button to select Reset, then press **Enter** button to enter sub-menu.

Software Update(USB)

Press ▼ / ▲ button to select Software Update (USB), plug your USB device in the USB slot, then press **Enter** button to update the right software.

HDMI CEC(Need to support the HDMI CEC/ARC function)

Press ▼ / ▲ button to select HDMI CEC, then press **Enter** button to enter the sub-menu.

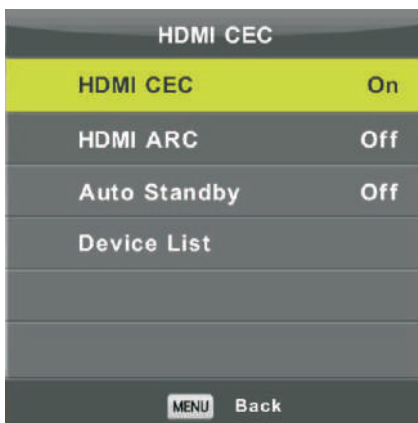

HDMI CEC Press ◀/▶ button to turn the HDMI CEC on or off.

HDMI ARC Press ◀/▶ button to turn the HDMI ARC on or off.

Auto Standby Press ◀/▶ button to turn the Auto Standby on or off.

Device List Press **Enter** button to open the main menu of device.

Screen Menu

Press **MENU** button to display the main menu.
Press ◀/▶ button to select **SCREEN** in the main menu.



1. Press ▼/▲ button to select the option that you want to adjust in the **SCREEN** menu.
2. Press **Enter** button to adjust.
3. After finishing your adjustment, Press **Enter** button to save and return to the previous menu.

Auto Adjust

Press **Enter** button to start adjusting **H-Offset/V-Offset/Size/Phase** automatically.

H-Offset.

Adjust the horizontal position of the picture.

Press ▼ / ▲ button to select **H-Offset**, then press **Enter** button to enter sub-menu.

V-Offset

Adjust the vertical position of the picture.

Press ▼ / ▲ button to select **V-Offset**, then press **Enter** button to enter sub-menu.

Size

Adjust the display size.

Press ▼ / ▲ button to select **Size**, then press **Enter** button to enter sub-menu.

Phase

Adjust the horizontal interfering lines.

Press ▼ / ▲ button to select **Phase**, then press **Enter** button to enter sub-menu.

Position Reset

Press ▼ / ▲ button to select **Position Reset**, then press **Enter** button to enter.

Notes:

1. Noise Reduction in PICTURE option is invalid.
2. AD Switch in SOUND option is invalid.
3. TIME menu and description are the same as that for Air mode.
4. Block Program and Parental Guidance in LOCK option is invalid.
5. Audio Languages, Subtitle Language, Hearing Impaired and PVR File System in SETUP option is invalid.
6. PC mode has no CHANNEL menu.

Media OPERATION

Note: Before operating **Media** menu, Plug in USB device, then press INPUT button to set the Input Source to **Media** .

Press ▼ / ▲ button to select **Media** in the Source menu, then press **Enter** button to enter.



Press ◀/▶ button to select the option you want to adjust in the main **Media** menu,
then press **Enter** button to enter.

Photo Menu

Press ◀/▶ button to select PHOTO in the main menu, then press **Enter** button to enter.

Press **Exit** button to return to the previous menu and exit menu to quit.



Press ◀/▶ button to select the file you want to watch in the file selecting menu, then press media button to display picture.

When highlighting the option you select, the file information will appear on the right and picture will be previewed in the center.

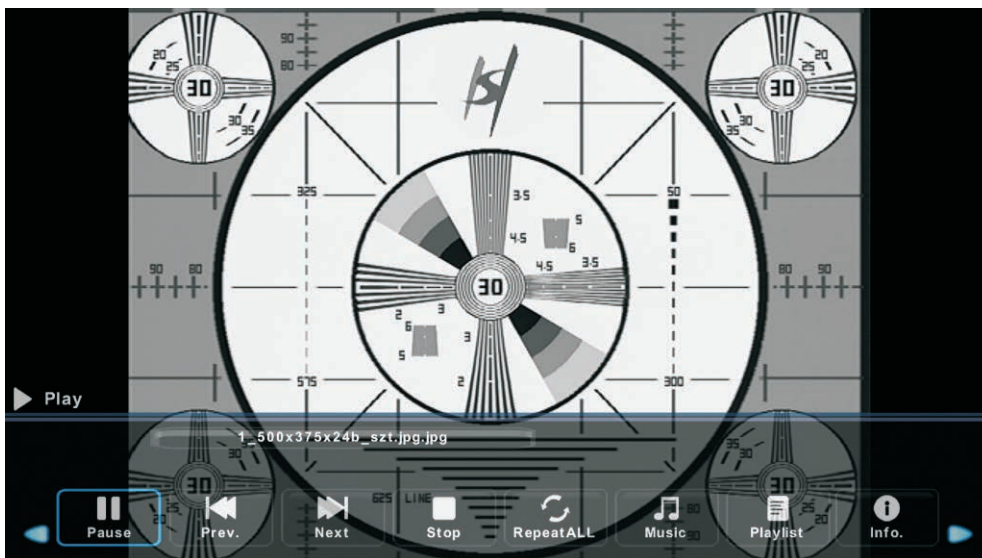

Music Menu

Press ◀/▶ button to select MUSIC in the main menu, then press **Enter** button to enter.

Press **Exit** button to return to the previous menu and exit menu to quit.



Press ◀/▶ button to select drive disk you want to watch, then press **Enter** button to enter.

Press ◀/▶ button to select return option to the previous menu.



Movie Menu

Press ◀/▶ button to select MOVIE in the main menu, then press **Enter** button to enter.

Press **Exit** button to return to the previous menu and exit menu to quit.



Press ◀/▶ button to select drive disk you want to watch, then press **Enter** button to enter.

Press media button to play the selected movie.

Press display button to select menu in the bottom you want to run, then press **Enter** button to operate.

Press **Exit** button to back to the previous menu and exit button to quit the entire menu.

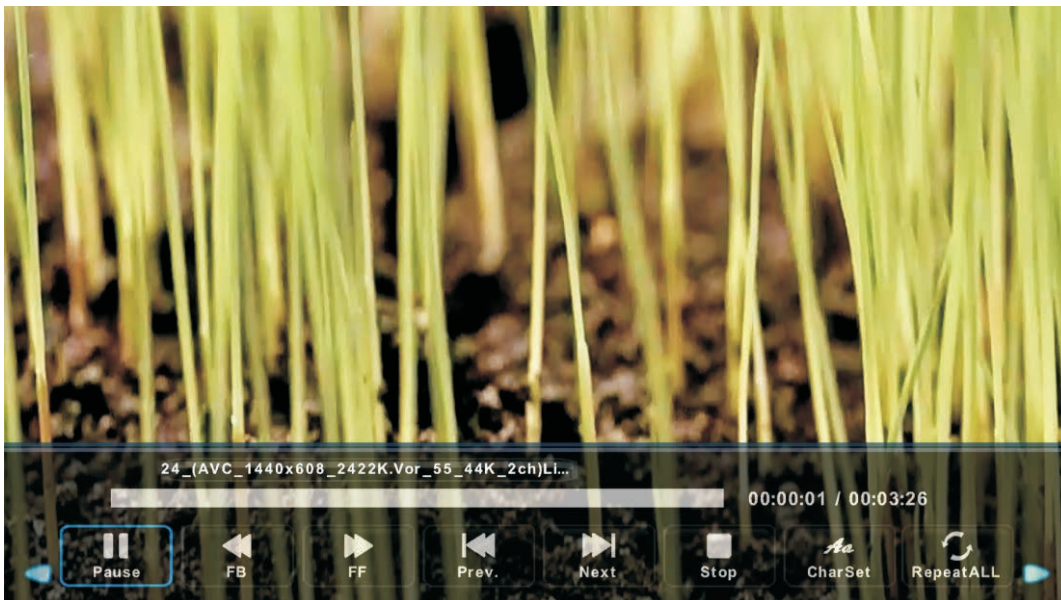

Text Menu

Press ◀/▶ button to select TEXT in the main menu, then press **Enter** button to enter.

Press **Exit** button to return to the previous menu and exit menu to quit.



Press ◀/▶ button to select drive disk you want to watch, then press **Enter** button to enter.

Press ◀/▶ button to select return option to back to the previous menu.

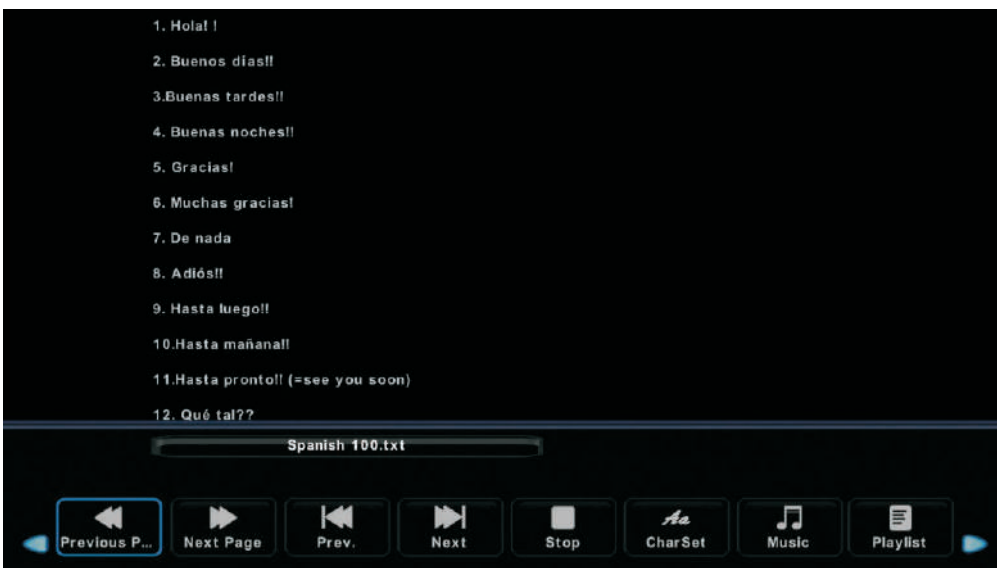

Help

No power	<ul style="list-style-type: none"> • Check if the AC cord of TV is plugged in or not. If there's still no power, please disconnect the plug, and reconnect to the socket after 60 seconds. Turn the power back on.
Signal not received properly	<ul style="list-style-type: none"> • Double or phantom images may appear on your TV if there are high buildings or mountains close to where you are. You can adjust the image thru manual operation: consult instruction of vernier regulation, or adjust the direction of the external antenna. • If you use an indoor antenna, under certain circumstances signal reception may be more difficult. Adjust the direction of the antenna for optimum reception. If this does not improve reception, you may have to switch to an external antenna.
No picture	<ul style="list-style-type: none"> • Check if the antenna at the back of the TV is connected properly. • View other channels to see if the problem still occurs.
Video appears with no audio	<ul style="list-style-type: none"> • Try increasing the volume. • Check if the TV's sound is on mute or not.
Audio is present, but video does not appear or is discolored	<ul style="list-style-type: none"> • Try adjusting the contrast and brightness.
Static noise affects video and audio quality	<ul style="list-style-type: none"> • Check if the antenna at the back of the TV is connected properly.
Broken lines on screen	<ul style="list-style-type: none"> • Electrical appliances such as hair dryers or vacuums etc. may be interfering with your TV set. Switch these appliances off.
Remote doesn't work	<ul style="list-style-type: none"> • Make sure the plastic bag which came with the remote control is removed. Try using the remote in a shorter distance from the TV. Check if the placement of the batteries is correct, or try using new batteries with the remote control. • The TV will go into Standby mode if it receives no response in a few minutes.
No video (PC mode)	<ul style="list-style-type: none"> • Please check if the cable is connected to the VGA port correctly, or if the cable is bent in some places.
Vertical line blinking (PC Mode)	<ul style="list-style-type: none"> • Enter the main menu, and adjust the vertical placement to eliminate the vertical line.
Horizontal tearing (PC Mode)	<ul style="list-style-type: none"> • Adjust the horizontal placement of the screen to clear any horizontal lines.
Screen is too bright or dark (PC Mode)	<ul style="list-style-type: none"> • Adjust the brightness or contrast in the main menu.
No response from the PC	<ul style="list-style-type: none"> • Check if the PC's display resolution is set to a compatible resolution for the TV.
Lines appearing when a device is connected to the RCA port	<ul style="list-style-type: none"> • Make sure you are using a cable of good quality.
Problems are unresolved	<ul style="list-style-type: none"> • Unplug the power cable and wait for 30 seconds, then reconnect to the socket. If problems still persist, do not attempt to repair the TV by yourself. Kindly contact the service center.

Do not leave your TV displaying a static image, whether it is from a paused video, menu screen, etc. for an extended period of time, doing so will damage the display and may cause image burn-in.

Specifications

Screen Size	TV System	Preset Channels	Speaker Output
28"	PAL/NTSC	PAL:0-199,NTSC:AIR 2-69 CABLE1-125	3W+3W
32"	PAL/NTSC	PAL:0-199,NTSC:AIR 2-69 CABLE1-125	8W+8W
39"/40"	PAL/NTSC	PAL:0-199 NTSC:AIR 2-69 CABLE1-125	8W+8W
42"	PAL/NTSC	PAL:0-199,NTSC:AIR 2-69 CABLE1-125	8W+8W
50"	PAL/NTSC	PAL:0-199,NTSC:AIR 2-69 CABLE1-125	8W+8W
55"	PAL/NTSC	PAL:0-199,NTSC:AIR 2-69 CABLE1-125	8W+8W
65"	PAL/NTSC	PAL:0-199,NTSC:AIR 2-69 CABLE1-125	8W+8W

Screen Size	power Consumption	Main accessories
28"	36W	User's manual x1 Remote controller x1 AAA Batteries x2
32"	56W	
39"/40"	70W	
42"	70W	
50"	108 W	
55"	135W	
65"	195W	

★ LIFE TIME : 60,000 Hrs



Manufactured under license from Dolby Laboratories. Dolby, Dolby Audio, Pro logic, and the double-D symbol are trademarks of Dolby Laboratories.

Remote Controller

1. **POWER** : Set your TV to power on or standby mode.
2. **MUTE** : Press to mute the sound. Press again or press VOL+ to unmute.
3. **0-9** : Press 0~9 to select a TV channel directly while watching TV. The channel will change after 2 seconds. Applicable for entering page number in teletext mode and so on.
4. **MTS** : Press to search the NICAM modes.
5. **MENU**: Allow you to navigate the on-screen menus.
6. **SOURCE**: Open the main menu ,press to list the sources
7. **▲▼◀▶ENTER**:Allow you to navigate the on-screen menus and adjust the system settings to your preference
8. **EXIT**: Exit from the menu or sub-menu and cancel the function in process (if applicable)
9. **DISPLAY**: Press to display the source and channel's info.
11. **VOL+/VOL-**: Press to increase / decrease the sound level.
12. **TV/RADIO** : When watching channel, allows you to switch between TV and Radio modes
13. **GUIDE**:1. Launches the EPG (Electronic Program Guide) 2. Fast reverse in PVR or Media Player mode.

Battery Installation:

Remove the battery compartment lid on the rear of the remote control by sliding the lid down, then off. Put two AAA batteries inside the battery compartment with their + and - ends aligned as indicated. Do not mix old and new batteries or different types of batteries.

Slide the lid until you hear it click into place.

Using the Remote Control:

Unless stated, otherwise, the remote control can operate all the features of the TV.

Always point the remote control directly at the remote sensor in front of the TV.

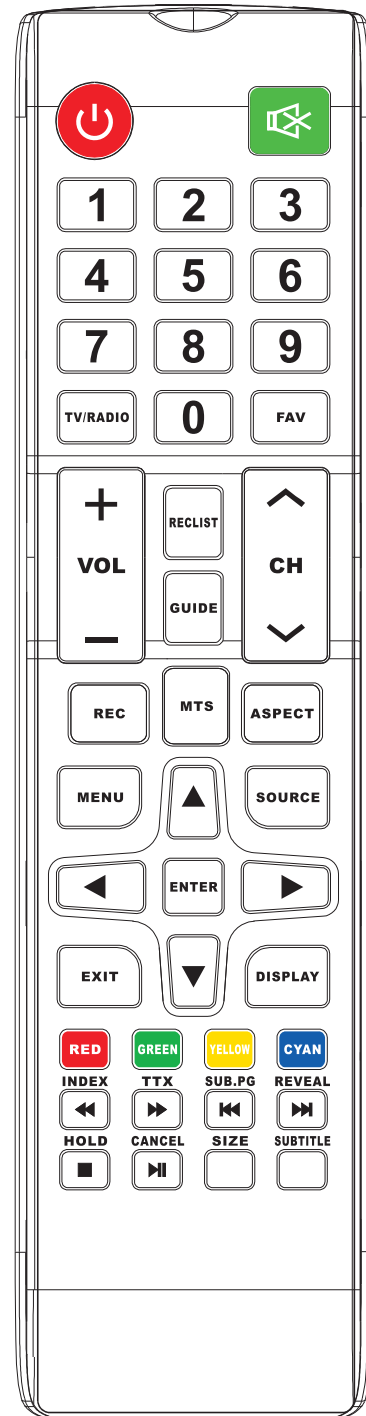

Remote Controller

14. **CANCEL:** 1. When a page is selected in the mode of text, it may take some time before it becomes available, pressing the CANCEL key will return to the TV mode. When the required page is found , the page number will appear at the top of the TV picture, press the CANCELkey to return to the mode of text for you to browse this page.
2. Previous chapter in PVR or Media Player mode
15. **INDEX:** 1. Request the Index page in Teletext mode.
2. Exit the playing function in PVR or Media Player mode.
16. **SIZE:** Change the size of display in Teletext mode.
17. **REVEAL:** Reveal or Hide the hidden words.
18. **COLOR BUTTONS:** Teletex switch of the analog parts, the items selection in the menu of the digital parts and the practice of the MHEG5 in the DVB menu.
19. **CH+/CH- :** Press to scan through channels.
20. **FAV :** press to open the favorite list.
then you can select the favorite channel.
21. **ASPECT:** 1. Select picture scale.
2. fast forward in PVR or Media Player mode.
22. **SUB. PG** 1. Press to access sub page.
2. Next chapter in PVR or Media Player mode.
23. **SUBTITLE:** To show and set the language of current DTV.
24. **HOLD:** HOLD On or Off for current page display .
25. **TTX :** Switch the teletext on and off.
26. **RECLIST:** Show the recorded list.
27. **REC:** Record begin in PVR mode.

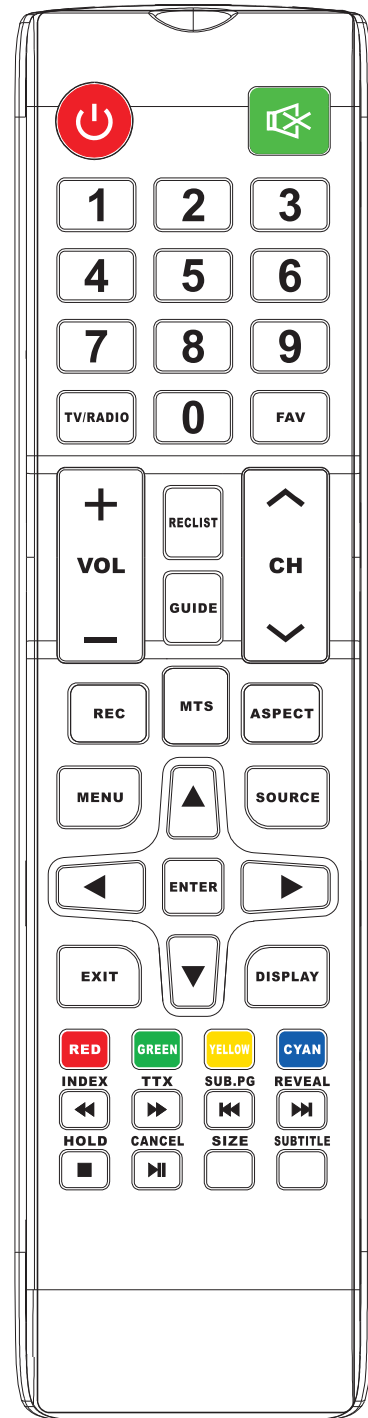



FOX[®]

be smart

HDMI[®]
HIGH DEFINITION MULTIMEDIA INTERFACE

UPUTSTVO ZA UPOTREBU

LED TELEVIZORI Model:39DLE172

Hvala Vam što ste kupili ovaj uređaj.

FOX LED televizori prepoznaju se po odličnim tehničkim karakteristikama, kao i modernom, funkcionalnom i elegantnom dizajnu. Osim toga konstantna unapređenja u vidu postprodajne podrške, izuzetno efikasna i rasprostranjena servisna mreža čine da se ponosni vlasnici **FOX televizora** mogu osećati sigurno.

Napravili ste pravi izbor.

U nastavku slede uputstva za upotrebu. Nisu komplikovana, ali ih se morate pridržavati.

EN

SR



Hvala Vam što ste kupili ovaj uređaj.

FOX LED televizori prepoznaju se po odličnim tehničkim karakteristikama, kao i modernom, funkcionalnom i elegantnom dizajnu. Osim toga konstantna unapređenja u vidu postprodajne podrške, izuzetno efikasna i rasprostranjena servisna mreža čine da se ponosni vlasnici **FOX televizora** mogu osećati sigurno.

Napravili ste pravi izbor.

U nastavku slede uputstva za upotrebu. Nisu komplikovana, ali ih se morate pridržavati.

Sadržaj

Priprema uređaja

Sigurnosne informacije	2
Važne bezbednosne instrukcije	3

Instaliranje i povezivanje televizora

Montaža držača	4
Tipke televizora i interfejs	5
Dijagram za povezivanje eksternih uređaja	6
Instaliranje i povezivanje televizora	7
Instalacija postolja televizora	7

TV Meni

Instalacija	8
Meni kanala	10
Meni slike	15
Meni zvuka	17
Sat i vreme	18
Zaključavanje menija	20
Hotel mod	22
Opcije	23

PC Meni

Displej	26
---------------	----

Media Meni

Rukovanje medijima	27
Meni slike	28
Meni muzike	29
Film meni	30
Tekst meni	31

Ostale informacije

Pomoć	32
Specifikacije	33
Daljinski upravljač	34

Sigurnosne informacije

OPREZ!

Ovaj uređaj koristi visoki napon. Da bi spriječili rizik od strujnog udara nemojte ga otvarati. U slučaju potrebe, obratite se kvalifikovanom servisnom licu

If the TV any changes or coarse adjustment, electric shocks to be hurt, do not attempt to open a machine-maintenance, customer contact centres needed overhaul.



Simbol sa znakom uzvika u jednakostraničnom trouglu upozorava korisnika da pogleda instrukcije za korišćenje i održavanje (popravku) u dokumentaciji isporučenom sa uređajem.



Upozorenje
Simbol munje u jednakostraničnom trouglu upozorava korisnika na prisustvo opasnog neizolovanog napona unutar proizvoda koji može biti dovoljan za rizik od strujnog udara

Važne mere bezbednosti

1. Pročitajte ovo uputstvo.
2. Čuvajte ovo uputstvo.
3. Obratite pažnju na sva upozorenja
4. Pratite sva uputstva.
5. Nemojte koristiti aparat u blizini vode.
6. Čistite uređaj samo sa suvom krpom.
7. Ne blokirajte otvore za ventilaciju. Instalirajte TV prema uputstvima proizvođača.
8. Ne stavljajte uređaj pored izvora toplote kao što su radijatori, grejači, šporeti i slični aparati
9. Nemojte oštetiti priključni kabl. Ako priključni kabl ne odgovara vašoj utičnici, potražite savet od električara.
10. Kabl za napajanje ne sme biti pritisnut ili uklešten, posebno u delu oko utičnice ili mestu gde kabl izlazi iz aparata.
11. Samo koristiti priložene/dodatke preporučene od strane proizvođača
12. Koristite nosač za montiranje na zid ili stalak od proverenih proizvođača. Ako koristite pokretni stalak za postavljanje TV-a, pazite da ga ne prevrnete kada okrećete stalak.
13. Uvek isključite televizor tokom grmljavine ili kada ga ne koristite na duži period.
14. Sve servisne radnje na uređaju mora obavljati samo kvalifikovano osoblje, a posebno ako je oštećen kabl za napajanje, ako ste slučajno sipali tečnost ina uređaj, ukoliko je aparat bio izložen vlazi ili kiši.
15. Ovaj uređaj nije namenjen za ugradnju (u delove nameštaja ili pregradne zidove koji ne obezbeđuju dovoljnu ventilaciju) osim ako izričito nije navedeno od strane proizvođača.
16. Aparat mora biti zaštićen od prskanja (voda, ulje itd)
17. Ne stavljajte nikakve predmete na uređaj (posude sa vodom, upaljene sveće, itd).
18. Montiranje uređaja na zid ili plafon-uređaj mora da bude instaliran na zid ili plafon u skladu sa uputstvima datim od strane proizvođača.
19. Da bi se smanjio rizik od požara ili električnih šokova ne izlažite kiši i vlazi...
20. Glavni prekidač se koristi i za isključivanje uređaja iz naponske mreže, isključivanje uređaja bi trebalo biti lako i dostupno.
21. Nikad nemojte postavljati televizor, daljinski upravljač ili baterije u blizini izvora koji proizvode toplotu ili direktno izloženo sunčevoj svetlosti.
22. Držite sveće i druge zapaljive predmete dalje od televizora, daljinskog upravljača i baterija radi sprečavanja širenja požara.
23. USB terminal je preporučljivo koristiti pri standardu 2.0 ili višem.
24. Baterije ne trebaju biti izložene toploti kao što je sunce, vatra ili slični toplotni izvori.
25. Ova oprema je klase II i dizajnirana je na takav način da ne zahteva sigurnosni priključak na uzemljenje.
26. Maksimalna temperatura na kojoj se koristi uređaj je 45 stepeni celzijusa.
27. Maksimalna nadmorska visina pri kojoj uređaj radi ispravno je 2000m.
28. Ovo je servisno uputstvo sastavljeno od strane kvalifikovanih servisera. Da bi se smanjio rizik od električnog udara ne pokušavajte uređajem rukovati drugačije nego što je sadržano u uputstvu.

Montaža nosača

Pričvršćivanje televizora za zid

1. Postavite uređaj na stolu. Ispod njega postavite tkaninu kojom ćete zaštititi displej od grebanja i oštećenja.
2. Upotrebite šrafciğer za skidanje šrafova kojima je fiksirano postolje televizora. Nakon uklanjanja šrafova pažljivo uklonite postolje.
3. Postavite nosač koji se može fiksirati na zid prema potrebnim dimenzijama na pozicijama koje su prikazane na slikama 2 i 3.
4. Probušite četiri rupe na zidu i uz pomoć 4 šrafa pričvrstite nosač na zid.
5. Uz pomoć šrafciğerera pričvrstite šrafove na televizoru i na zidu.

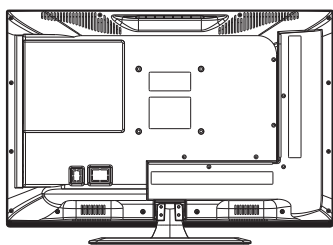

1

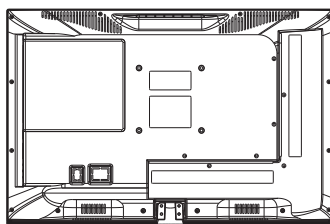

2

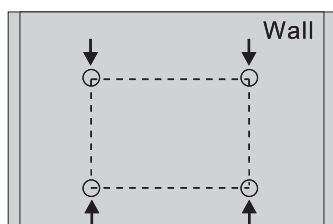

3

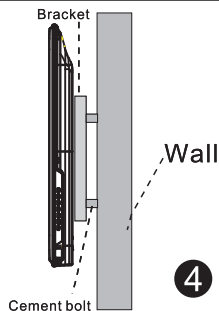

Beleška:

1. Nosač za TV je opcioni dodatak i on ne dođe u pakovanju.
2. Kada postavite TV oko njega ne smije biti drugih predmeta. Držite ga udaljenog od drugih predmeta..
3. Pratite uputstva za montiranje nosača.
4. Televizor zakačite na nosač koji odgovara njegovim dimenzijama.

NAPOMENA

UKOLIKO PROGRAM PRATITE PUTEM KABLOVSKE TELEVIJIZIJE PROVERITE DA LI JE PROPISNO IZVEDENO UZEMLJENJE I IZJEDNAČAVANJE POTENCIJALA NA KABLU VAŠEG KABLOVSKOG OPERATERA.

ZA OVE INFORMACIJE KONTAKTIRAJTE VAŠEG KABLOVSKOG OPERATERA.

Tipke na televizoru i interfejs

Tipke

Napomena: Šema i opis su samo primeri, položaj dugmića može da varira u zavisnosti od modela



: Dugme za Uključenje/Isključenje.

SOURCE: Odabir izvora signala.











MENU: Prikazuje glavni meni.

CH+/-: Odabir kanala.

VOL+/-: Podešavanje jačine zvuka.

Priključci

Napomena: Položaj i tip interfejsa su različiti za različite modele TV-a.

	AV ulaz Eksterni ulaz za AV signal		Slusalice izlaz Kada su slusalice uključene, zvučnici se automatski isključuju
	Čitackartica CI, zahtevaCAM (moduluslovnogpristupa) koristi se za placenu T6 Izlaz levog i desnog kanala audio/vide signala (neki modeli nemaju ovaj konektor)		USB ulaz Povežite USB uređaj za Reprodukciju fajlova ili čuvanje Sadržaja preko PVR funkcije.
	YpPb Pr ulaz Povežite sa kompozitnim terminalom vašeg DVD/VCR		COAXIAL izlaz Priključite SPDIF prijemnik.
	HDMI ulaz Digitalni ulaz iz HDMI konektora		Ulaz za PC analogni signal Za povezivanje PC-a
	ANT 75 Povežite TV ulaz antene, kabla (75/VHF/UHF)		PC AUDIO ULAZ Audio ulaz kada je VGA uključen.

Dijagram za povezivanje eksternih uređaja

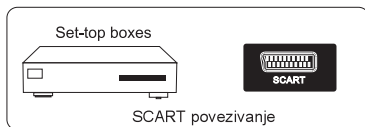
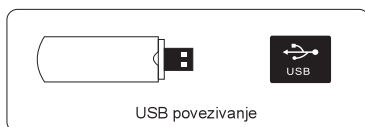
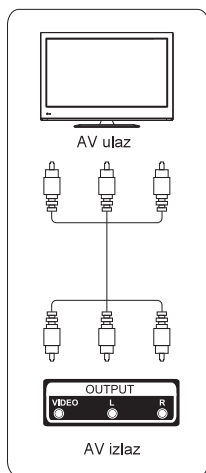
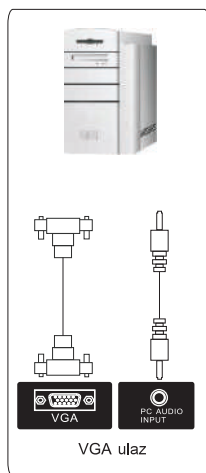
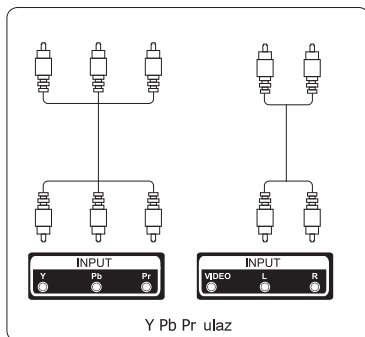
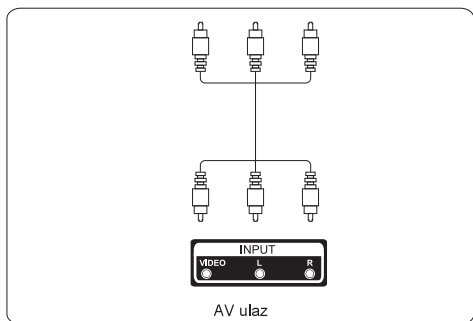
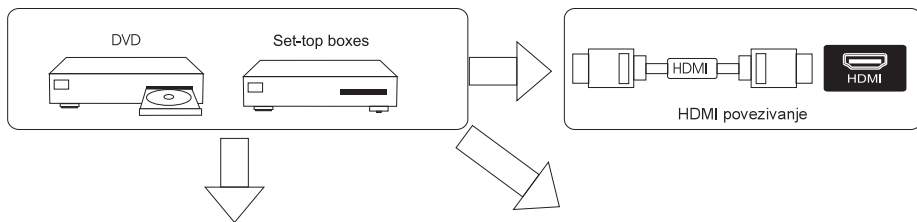

Instaliranje i povezivanje televizora

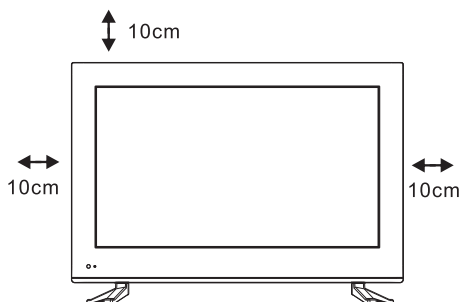

Podešavanje Vašeg TV-a

Televizor postavite na stabilno mesto koje može da izdrži njegovu težinu. Da bi izbegli moguće opasnosti ne postavljajte televizor na mesta koja su u blizini vode ili toplote (kao što je lampa, sveća, grejač) i ne blokirajte otvore za ventilaciju sa zadnje strane televizora.

Povezivanje antene i napajanja

1. Povežite antenski kabl u utičnicu za povezivanje antene sa zadnje strane televizora.
2. Za uključivanje kabla u TV (AC 100-240V~ 50/60Hz).

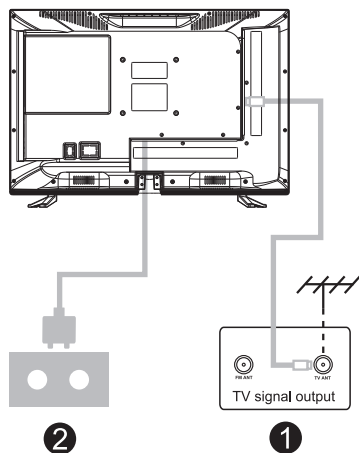

Uključite TV

3. Pritisnite tipku da uključivanje na uređaju, zelena signalna lampica će se uključiti. Ako je indikator u režimu mirovanja (svetli crveno), pritisnite dugme za uključivanje na daljinskom upravljaču da uključite TV.

Napomena:

Slika je indikativna.

Uputstvo za instalaciju postolja

1. Otvorite pakovanje i izvadite TV uređaj.
2. Da bi se izbegla oštećenja TV-a, prekrijte ekran mekim materijalom i stavite ga na ravan sto sa licem na dole i mekim materijalom ispod, bazu postolja pričvrstite sa šarafima.
3. Šarafe dobro pričvrstite kako bi se postolje dobro uklopilo uz TV
4. Instalacija je kompletna

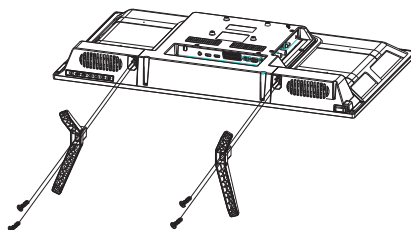

Prva instalacija

Povote antenski kabl u RF priključak na TV-u.

Odabir jezika

Pritisnite ◀ / ▶ tipke za odabir jezika koji će se koristiti u meniju i porukama.

Odabir zemlje

Pritisnite ▼ / ▲ za selekciju zemlje

Pritisnite ◀ / ▶ da odaberete željenu zemlju.

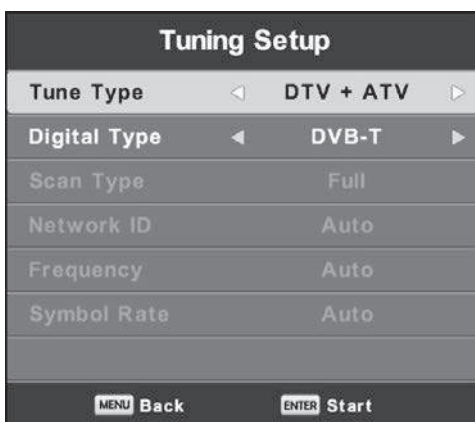
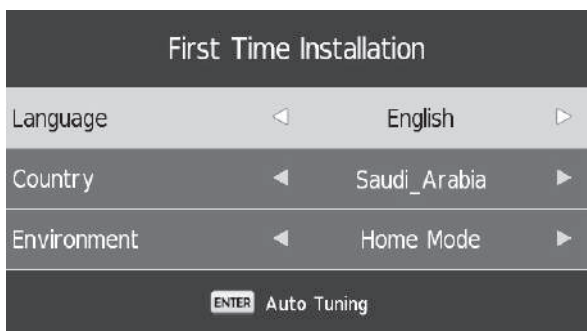

Meni kanala

Pritisnite **MENU** tipku za prikaz menija.

Pritisnite ◀/▶ tipku da odaberete kanale u glavno meniju.

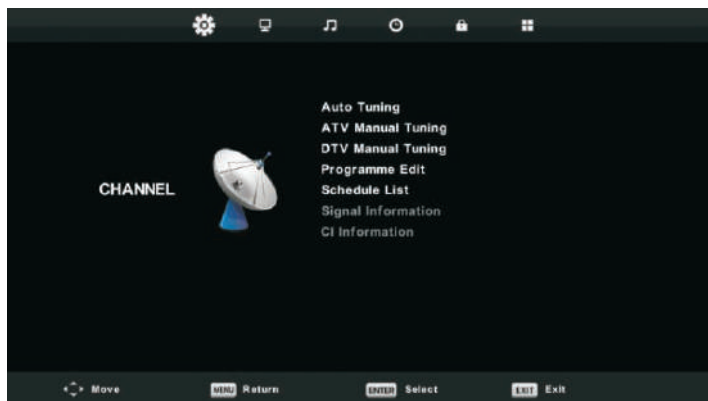

1. Pritisnite ▼/▲ tipke za selekciju opcije koju želite da prilagodite u meniju kanala.
2. Pritisnite tipku Enter za prilagođavanje.
3. Nakon prilagođavanja, pritisnite tipku Enter da sačuvate izmene i povratak na prethodni meni.

Automatsko tjuniranje

Pritisnite ▼/▲ tipke za selektovanje automatskog tjuniranja, zatim pritisnite Enter za ulazak.

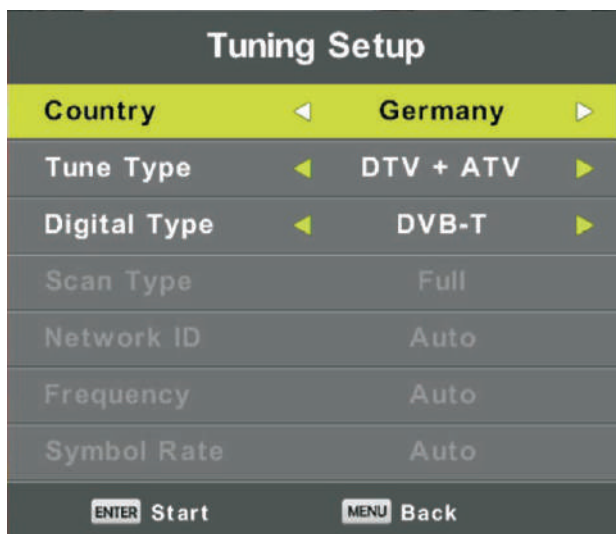

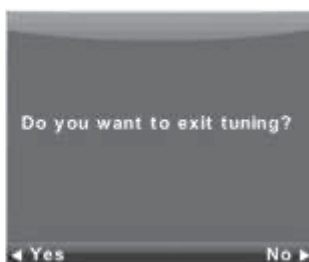
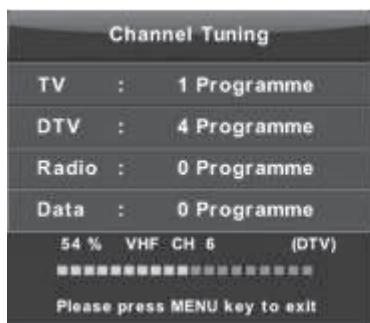

Manuelno tjuniranje analognih kanala



Trenutni kanal. Podešavanje broja kanala.
Sistem boja
Odabir sistema boja
(Dostupni sistemi: AUTO, PAL, SECAM)

Sistem zvuka
Odabir sistema zvuka

Fino tjuniranje
Ručno podešavanje frekvencije kanala

Pretraga
Pregraga kanala

Manuelno tjuniranje digitalnih kanala

Pritisnite ▼ / ▲ tipke za odabir manualnog tjuniranja, zatim pritisnite Enter za ulazak u podmeni.
Pritisnite ◀ / ▶ tipke za odabir broj kanala, zatim pritisnite enter za pretragu kanala.



Izmene programa

Pritisnite ▼ / ▲ tipke za označavanje kanala koji želite izmeniti, zatim pritisnite Enter za ulazak u podmeni.



Tri obojene tipke su prečice za programiranje kanala.

Prvo pritisnite ▼ / ▲ da označite željeni kanal

Pritisnite **crvenu** tipku da obrišete kanal sa liste.

Pritisnite **zutu** tipku da pomerite kanal u listi omiljenih.

Pritisnite **plavu** tipku da preskočite označeni kanal.

Pritisnite FAV tipku da dodate ili uklonite kanal sa liste omiljenih. (Vaš TV će automatsko preskočiti kanale kada koristite CH+/- za pregled kanala)

Planirala lista

Pritisnite ▼ / ▲ za označavanje zakazane liste, zatim pritisnite Enter za ulazak u podmeni.

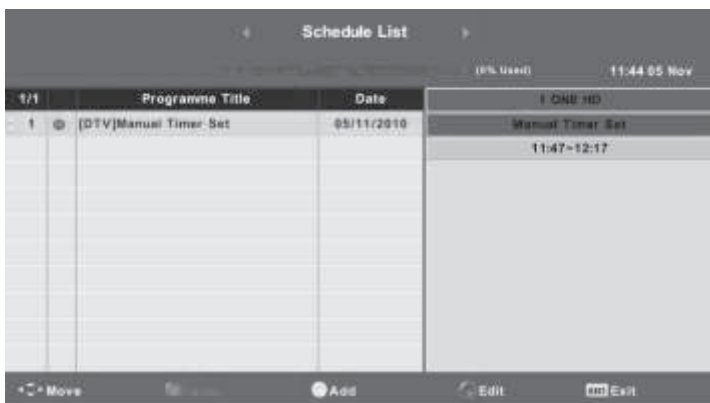

Pritisnite ŽUTU tipku za ulaz u prozoru koji je prikazan dolje.

Kada uneseno vreme nije dobro prikazaće se poruka upozorenja.



Informacije o signalu

Pritisnite ▼ / ▲ tipke za odabir informacija o signalu, zatim pritisnite Enter tipku da bi pogledali detaljne informacije. Ova opcija je dostupna samo kod digitalnih kanala.



CI informacije (ukoliko je podržana CI funkcija)

Pritisnite ▼ / ▲ tipke za odabir CI informacija, zatim pritisnite Enter tipku za prikaz detalja ukoliko je ubačena CI kartica.

Lista kanala za satelitske kanale. (ukoliko je podržana DVB-S2 funkcija)



Automatsko tjuniranje

Pritisnite ∇ / \blacktriangle button tipke za automatsko tjuniranje, zatim tipku Enter \blacktriangleright za ulazak.

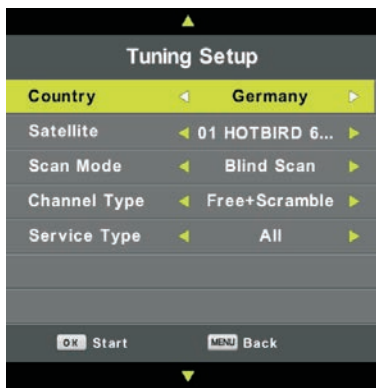

Podešavanje tanjira

Pritisnite ∇ / \blacktriangle tipke za odabir podešavanja tanjira, zatim pritisnite Enter/ \blacktriangleright

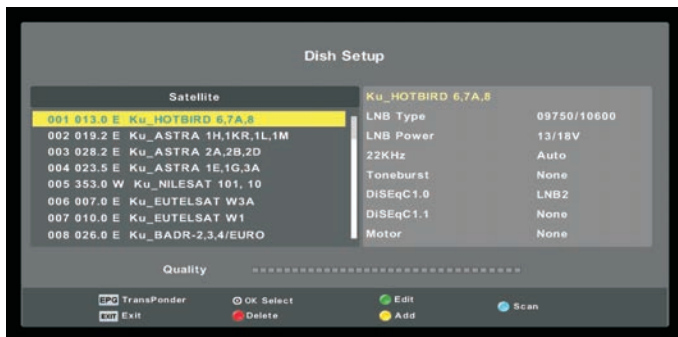

Meni slike

Pritisnite **MENU** tipku za prikaz glavnog menija.

Pritisnite ◀/ ▶ tipke za odabir **SLIKA** u glavnom meniju.

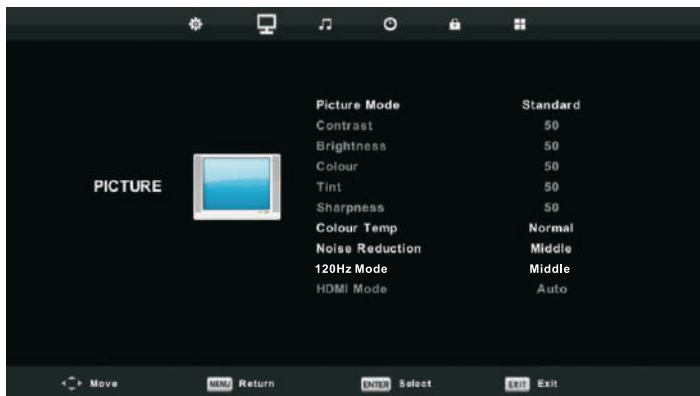

Napomena: 120Hz mod je dostupan samo kod UHD TV-a

1. Pritisnite ▼/▲ tipke za odabir opcije koju želite da prilagodite u meniju slike.
2. Pritisnite OK za prilagođavanje.
3. Nakon završetka prilagođavanja, pritisnite MENU tipku da sačuvate i vratite se na prethodni meni.

Mod slike

Pritisnite ▼/▲ tipke za odabir moda slike, zatim pritisnite OK za ulazak u podmeni.

Možete menjati vrednosti kontrasta, zatamnjenosti, boje, oštine i nijanse kada ste u korisničkom modu.

Pritiskom na tipku PMODE možete direktno menjati mod slike.

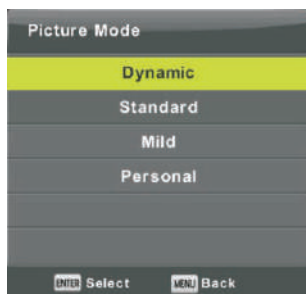

Kontrast/ Zatamnjenost/ Boja/ Nijansa/ Oštrina

Pritisnite ▼/▲ tipke za obeležavanje opcije, zatim pritisnite ENTER/ ▶ tipku za prilagođavanje.

Kontrast: Prilagođavanje osvetljenih delova slikem, senke će biti nepromenjene.

Zatamnjenost: Podešavanje zatamnjenosti slike

Boja: Podešavanje željene saturacije slike.

Nijansa: Koristi se za podešavanje nijanse boje.

Oštrina: Prilagođavanje vidljivih detalja na slici.

Boja temperature



Promena temperature boje.

Pritisnite ▼ / ▲ tipku za odabir temperature boje, zatim pritisnite OK za ulazak u podmeni.

Pritisnite ▼ / ▲ tipku za odabir moda (hladan, normalan, topao). Kada ste u korisničkom modu možete posebno menjati vrednosti crvene, zelene i plave boje.

Hladan: povećava nivo plave boje u belo

Normalan: povećava nivo boja povezanih sa belom

Topao: povećava nivo crvene u belo

Redukcija šuma

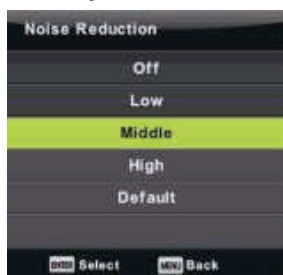

Koristi se za uklanjanje ili smanjenje šuma slike.

Pritisnite ▼ / ▲ tipku za odabir šuma slike, zatim pritisnite OK tipku za ulazak u podmeni.

Isključeno: Isključenje redukcije šuma

Nisko: Detektuje i umanjuje niski video šum

Srednje: Detektuje i umanjuje srednji video šum

Visoko: Detektuje i umanjuje visoki video šum

Podrazumevano

120Hz mod (samo kod UHD TV-a)



Koristi se za bolji prikaz pokreta.

Veća vrednost omogućava bolji prikaz pokreta prilikom gledanja sportskih kanala ili igrica.

Pritisnite ▼ / ▲ tipke za odabir (Isključeno, nisko, srednje, visoko)

HDMI mod



Pritisnite ▼ / ▲ tipke za odabir HDMI moda, zatim pritisnite OK za ulazak u podmeni.

Pritisnite ▼ / ▲ tipke za odabir dostupnog moda slike (Auto, Video, PC)

Mod zvuka

Pritisnite **MENU** tipku za prikaz glavnog menija.

Pritisnite ◀/▶ tipke za odabir **ZVUK** u glavnom meniju.

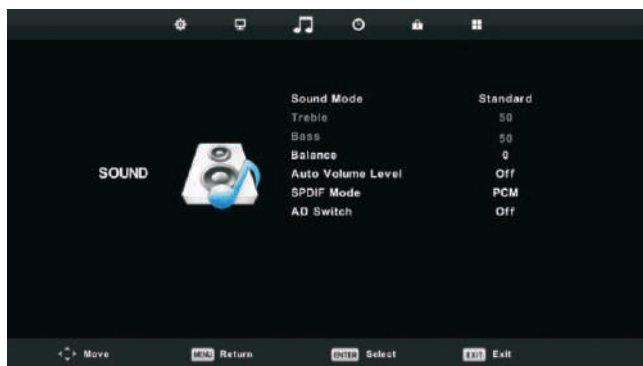

1. Pritisnite ▼/▲ tipke za obilježavanje opcije koju želite prilagoditi u meniju zvuka.
2. Pritisnite Enter tipku za prilagođavanje.
3. Nakon prilagođavanja, pritisnite **Enter** tipku da sačuvate podešavanja i vratite se na glavni meni.

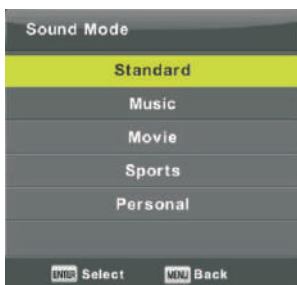

Mod zvuka

Pritisnite ▼/▲ tipke za odabir moda zvuka
zatim pritisnite **Enter** tipku za ulazak u podmeni.
Pritisnite ▼/▲ tipke za odabir.

U korisničkom modu možete međi vrednost visokotonca i basa.

Pritiskom na tipku **S.MODE** možete direktno menjati mod zvuka.

Standardni: Prilagođen svim okruženjima

Muzika: Prilagođava se muzičkim kanalima, za što originalniji zvuk.

Film: Prilagođava visokotonac i bas za što bogatiji zvuk.

Sport: Prilagođava vokal za sportske kanale.

Korisnički: Sami podešavate željene vrednosti.

Balans

Pritisnite ▼/▲ tipke za obilježavanje opcije, Pritisnite ◀/▶ tipke za prilagođavanje.

Automatska jačina zvuka

Pritisnite ▼/▲ tipke za obilježavanje automatske jačine zvuka, zatim pritisnite ◀/▶ tipke za uključivanje i isključivanje.

SPDIF mod

Pritisnite ▼/▲ tipke za obilježavanje SPDIF moda, zatim pritisnite ◀/▶ tipke za Isključeno/PCM/Auto

AD prekidač

Pritisnite ▼/▲ tipke za obilježavanje **AD**, zatim pritisnite ◀/▶ tipke za uključivanje i isključivanje.

VREME

Pritisnite **MENU** dugme za prikaz glavnog menija.
Pritisnite ◀/▶ tipke za odabir vremena u glavnom meniju.



1. Pritisnite ▼/▲ tipke za obeležavanje opcije koju želite da prilagodite.
2. Pritisnite **Enter** tipku za prilagođavanje.
3. Nakon prilagođavanja, pritisnite **Enter** tipku za čuvanje i povratak u prethodni meni.

Vremenska zona

Pritisnite ▼/▲ tipke za odabir vremenske zone, zatim pritisnite **Enter** tipku za ulazak u podmeni.

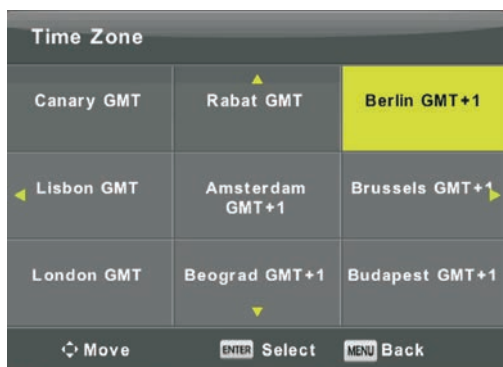

Pritisnite ▼/▲◀/▶ tipke za odabir vremenske zone.

Tajmer za spavanje

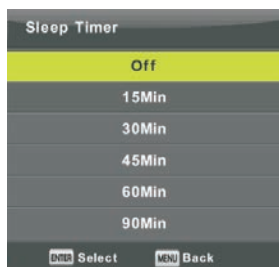

Pritisnite ▼/▲ tipke za odabir spavanja, zatim pritisnite **Enter** za ulazak u podmeni.

Pritisnite ◀/▶

Automatsko spavanje



Pritisnite ▼ / ▲ tipke za odabir automatskog spavanja, zatim pritisnite **Enter** tipku za ulazak u podmeni.

Pritisnite ▼ / ▲ tipke za odabir.

Napomena: Vreme se računa od zadnje operacije koja je urađena sa daljinskim upravljačem.

OSD tajmer



Pritisnite ▼ / ▲ za odabir OSD tajmer, zatim pritisnite Enter tipku za ulazak u podmeni.

Pritisnite ◀ / ▶ tipke za odabir.

Zaključavanje menija

Pritisnite **MENU** tipku za ulazak u glavni meni

Pritisnite ◀/▶ tipke za označavanje menija za zaključavanje.

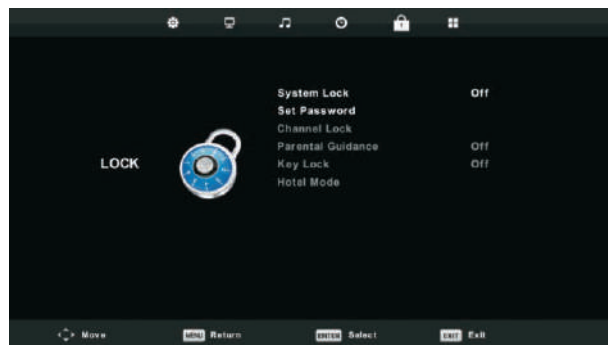

1. Pritisnite ▼ / ▲ tipku da obeležite opciju koju želite da prilagodite u sistemu za zaključavanje.
2. Pritisnite Enter/◀/▶ tipku za prilagođavanje.
3. Nakon prilagođavanja, pritisnite **MENU** tipku za povratak na prethodni meni.

Zaključavanje sistema



Pritisnite ▼ / ▲ tipke za obilježavanje zaključavanja sistema, zatim pritisnite **Enter** tipku da bi aktivirali sledeću opciju.

Podrazumevana lozinka je 0000, ukoliko zaboravite lozinku koju ste uneli, kontaktirajte servisni centar.

Unos lozinke



Pritisnite ▼ / ▲ tipke da bi obeležili unos lozinke, zatim pritisnite **Enter** za ulazak u podmeni i unos lozinke.

Zaključavanje kanala



Pritisnite **▼** / **▲** tipke za odabir zaključavanja kanala zatim pritisnite **Enter** za ulazak u podmeni. Pritisnite zelenu tipku za zaključavanje ili otključavanje kanala.

Roditeljska kontrola



Pritisnite **▼** / **▲** tipke za odabir roditeljske kontrole zatim pritisnite **Enter** tipku za ulazak u podmeni gde možete odabrati godine Vašeg deteta.

Zaključavanje tipke

Pritisnite **▼** / **▲** tipke da označite zaključavanje tipke, zatim pritisnite **◀** / **▶** tipke za uključivanje ili isključivanje.

Kada je status "uključen", tipka se ne može koristiti.

Hotel mod (potrebna je podrška za Hotel mod)

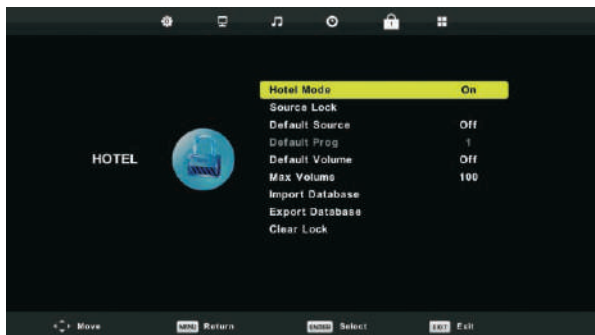

1. Pritisnite ▼ / ▲ tipke na daljinskom upravljaču za odabir hotel moda u Meniju za zaključavanje.
2. Pritisnite **Enter** tipku na daljinskom upravljaču za ulazak u podmeni.
3. Nakon prilagođavanja, pritisnite **MENU** tipku da sačuvate i vratite se na prethodni meni.

Hotel mod

Pritisnite ▼ / ▲ tipke za označavanje Hotelskog moda, zatim pritisnite ◀ / ▶ tipke za uključenje ili isključenje.

Zaključavanje izvora

Pritisnite ▼ / ▲ tipke da označite zaključavanje izvora, zatim pritisnite **Enter** tipku za ulazak u podmeni.

Podrazumevani izvor

Pritisnite ▼ / ▲ tipke za odabir podrazumevanog izvora signala, zatim pritisnite **Enter** tipku za ulazak u podmeni i selekciju.

Podrazumevani kanal

Pritisnite ▼ / ▲ tipke za odabir podrazumevanog kanala, zatim pritisnite ◀ / ▶ tipke za prilagođavanje.

Dostupno je kada je podrazumevani izvor TV.

Maksimalna jačina zvuka

Pritisnite ▼ / ▲ tipke za odabir maksimalne jačine zvuka, zatim pritisnite ◀ / ▶ tipke za prilagođavanje.

Obrisi zaključavanja

Pritisnite ▼ / ▲ tipke za brisanje zaključavanja, zatim pritisnite **Enter** tipku da očistite podešavanja koja ste napravili ranije.

Opcije

Pritisnite **MENU** tipku za ulazak u glavni meni.

Pritisnite ◀ / ▶ tipke za odabir **OPCIJA** u glavnom meniju.



1. Pritisnite ▼ / ▲ tipke za označavane opcije koju želite da podesite u meniju.
2. Pritisnite **Enter** tipku za prilagođavanje.
3. Nakon prilagođavanja, pritisnite **Enter** tipku da sačuvate i vratite se na prethodni meni.

OSD jezik

Odaberite OSD jezik menija. Engleski jezik je izabran kao podrazumevani.

Pritisnite ▼ / ▲ / ◀ / ▶ tipke za odabir jezika menija.



TT jezik

Pritisnite ▼ / ▲ tipke za odabir TT jezika, zatim pritisnite **Enter** tipku za ulazak u podmeni. Pritisnite ▼ / ▲ / ◀ / ▶



Audio jezici

Pritisnite **▼ / ▲** tipke za odabir Audio jezika, zatim pritisnite **Enter** tipku za ulazak u podmeni. Pritisnite **◀ / ▶** tipke za odabir primarnog Audio jezika.

Pritisnite **▼ / ▲ / ◀ / ▶** tipke za odabir Audio jezika.



Jezik prevoda

Pritisnite **▼ / ▲** tipke za odabir jezika prevoda, zatim pritisnite **Enter** tipku za ulazak u podmeni. Pritisnite **◀ / ▶** tipke za odabir primarnog jezika prevoda.

Pritisnite **▼ / ▲ / ◀ / ▶** tipke za odabir jezika prevoda.



Oslabljen sluh

Pritisnite **▼ / ▲** tipke za označavanje oslabljenog sluha, zatim pritisnite **Enter** tipku za uključivanje ili isključivanje.

PVR fajl sistem

Pritisnite **▼ / ▲** tipke za označavanje PVD fajl sistema, zatim pritisnite **Enter** tipku za ulazak u podmeni.

Pritisnite **▼ / ▲** tipke da označite proveru PVR fajl sistema, zatim pritisnite **Enter** tipku za ulazak. Nakon toga će biti proverena brzina USB-a.



Format slike

Pritisnite **▼ / ▲** tipke za odabir Formata slike, zatim pritisnite **Enter** tipku za ulazak u podmeni. Pritisnite **▼ / ▲** tipke za odabir formata slike. (Dostupne opcije: Auto, 4:3, 16:9, Zum1, Zum2)



Plavi ekran

Pritisnite **▼ / ▲** tipke za odabir plavog ekrana, zatim pritisnite **Enter** tipku za uključenje ili isključenje.

Prva instalacija

Pritisnite **▼ / ▲** tipke za odabir prve instalacije, zatim pritisnite **Enter** tipku za ulazak.

Reset

Pritisnite **▼ / ▲** tipke za odabir Reset funkcije, zatim pritisnite **Enter** tipku za ulazak u podmeni.

Nadogradnja softvera (USB)

Pritisnite **▼ / ▲** tipke da označite nadogradnju softvera (USB), uključite Vaš USB uređaj u predviđeni slot, zatim pritisnite **Enter** tipku za nadogradnju pravog softvera.

HDMI CEC (potrebna je podrška za HDMI CEC/ARC funkciju)

Pritisnite **▼ / ▲** tipke za odabir HDMI CEC, zatim pritisnite **Enter** tipku za ulazak u podmeni.



HDMI CEC Pritisnite **◀ / ▶** tipke da uključite ili isključite HDMI CEC

HDMI ARC Pritisnite **/ ▶** tipku da uključite ili isključite HDMI ARC

Automatsko spavanje Pritisnite **◀ / ▶** tipke da uključite ili isključite automatsko spavanje.

Lista uređaja Pritisnite **Enter** tipku da otvorite glavni meni uređaja.

Meni ekrana

Pritisnite **MENU** tipku za prikaz glavnog menija

Pritisnite ◀/▶ tipke za odabir Ekrana u glavnom meniju.



1. Pritisnite ▼/▲ tipke za odabirete opciju koju želite da prilagodite
2. Pritisnite **Enter** tipku za prilagođavanje.
3. Nakon prilagođavanja, pritisnite **Enter** tipku da sačuvate i vratite se na prethodni meni.

Automatsko prilagođavanje

Pritisnite **Enter** tipku da započnete automatsko prilagođavanje.

H-Offset

Prilagođavanje horizontalne pozicije slike.

Pritisnite ▼/▲ tipke da odaberete **H-Offset**, zatim pritisnite **Enter** tipku da uđete u podmeni.

V-Offset

Prilagođavanje vertikalne pozicije slike.

Pritisnite ▼/▲ tipke da odaberete **V-Offset**, zatim pritisnite **Enter** tipku da uđete u podmeni.

Veličina

Prilagođavanje veličine slike

Pritisnite ▼/▲ tipke da odaberete veličinu, zatim pritisnite **Enter** tipku da uđete u podmeni.

Faza

Podešavanje horizontalnih interferentnih linija.

Pritisnite ▼/▲ tipke da odaberete fazu, zatim pritisnite **Enter** tipku da uđete u podmeni.

Reset pozicije

Pritisnite ▼/▲ tipke da odaberete reset pozicije, zatim pritisnite **Enter** za ulazak.

Napomene:

Opcija za redukciju šuma nije dostupna u modu slike.

AD prekidač nije dostupan u modu zvuka.

Meni za vreme je isti kao i kod moda za vanjsku antenu

Blokiranje programa i roditeljska zaštita nijesu dostupni u modu za zaključavanje

Audio jezik, jezik prevoda, oslabljen sluh i PVR fajl sistem u opcijama nijesu dostupni.

PC mod nije dostupan u meniju kanala.

Upravljanje medijima

Napomena: da bi upravljali medijima, potrebno je da uključite USB uređaj, zatim da pritisnete **INPUT** tipku da bi odabrali izvor medija.

Pritisnite ▼/▲ tipke da odaberete medij kao izvor, zatim pritisnite Enter za ulaz.



Pritisnite ◀/▶ tipke da odaberete opciju koju želite prilagoditi u meniju, zatim pritisnite **Enter** tipku za ulazak.

Meni slike

Pritisnite ◀/▶ tipke da odaberete SLIKA u glavnom meniju, zatim pritisnite **Enter** tipku za ulaz. Pritisnite **Exit** tipku za povratak na prethodni meni i Izlaz ukoliko želite da izađete.



Pritisnite ◀/▶ tipke da odaberete fajl koji želite da pregledate, zatim pritisnite **media** tipku za prikaz fotografije.

Kada pregledate opcije, informacije će se pojaviti na desnom delu, a fotografija će biti prikazana u centralnom delu.

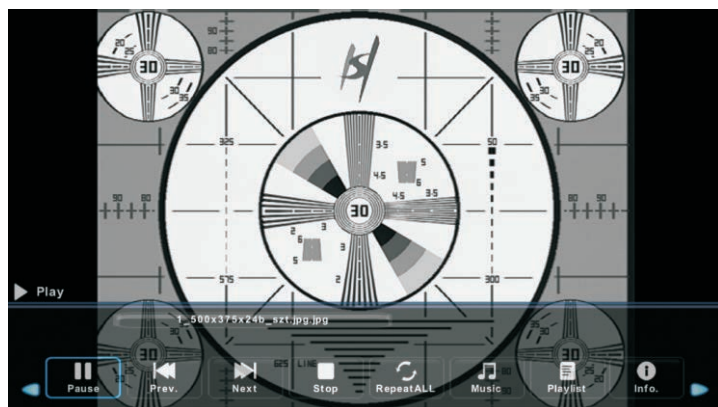

Muzički meni

Pritisnite ◀/▶ tipke da odaberete MUZIKA u glavnom meniju, zatim pritisnite **Enter** za ulazak. Pritisnite **Exit** tipku za povratak na prethodni meni i Izlaz, za izlaz iz menija.



Pritisnite ◀/▶ tipke da odaberete disk koji želite, zatim pritisnite **Enter** tipku za ulazak. Pritisnite ◀/▶ tipke da odaberete opciju za povratak na prethodni meni.



Meni filma

Pritisnite ◀/▶ tipke da odaberete FILM u glavnom meniju, zatim pritisnite **Enter** tipku za ulazak. Pritisnite **Exit** tipku za povratak na prethodni meni i Izlaz, za izlaz iz menija.



Pritisnite ◀/▶ tipke da odaberete disk koji želite, zatim pritisnite **Enter** tipku za ulazak.

Pritisnite Media tipku za reprodukciju filma.

Pritisnite **Display** tipku za prikaz menija na dnu, zatim pritisnite **Enter** tipku za upravljanje.

Pritisnite **Exit** tipku za povratak na prethodni meni i Izlaz za zavratanje menija.

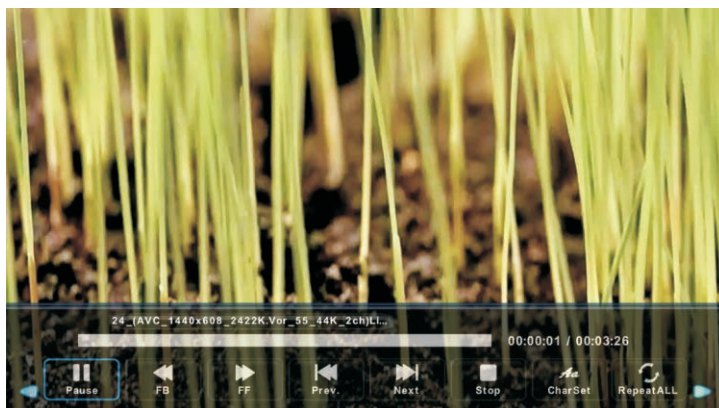

Tekst meni

Pritisnite ◀/▶ tipke da odaberete TEKST u glavnom meniju, zatim pritisnite **Enter** tipku za ulazak. Pritisnite **Exit** tipku za povratak na prethodni meni i Izlaz, za izlaz iz menija.



Pritisnite ◀/▶ tipke da odaberete disk koji želite, zatim pritisnite **Enter** tipku za ulazak. Pritisnite ◀/▶ tipke da odaberete opciju za povratak na prethodni meni.

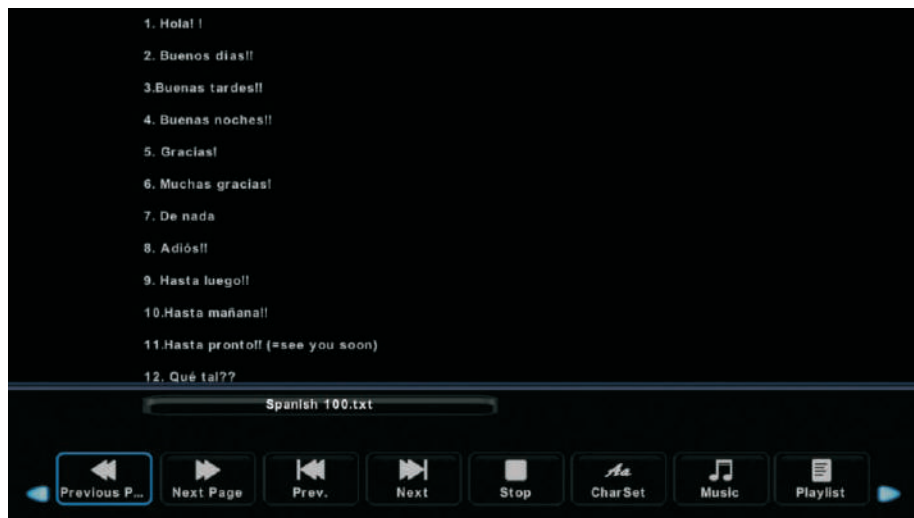

POMOĆ

Nema struje

Proverite da li je kabl za napajanje TV-a uključen. Ako i dalje nema struje isključite ga i nakon 60 sekundi uključite ponovo.

Signal nije pravilno primljen.

Moguće je da se prikaže dvostruka slika ili fantomska slika ako postoji bilo kakva visoka zgrada ili planina u blizini. Možete ručno podesiti sliku, slijedite uputstva kablovskog operatera ili promenite smer spoljnih kanala.

Nema slike

Proverite da li je antena sa zadnje strane televizora povezana ispravno. Pokušajte da izab erete neki drugi kanal i proverite da li je problem u nečem drugom.

Dobra slika, ali nema zvuka

Povećajte jačinu zvuka. Proverite da li je televizor u stanju pripravnosti i pritisnite ON. Zvuk se dobro čuje, ali boje nijesu realne ili nema slike

Proverite da li je antena na zadnjoj strani televizora povezana ili ne.

Poremećen nivo zvuka

Električni uređaj (fen npr.) može uticati na osećaj jačine zvuka. Isključite sve slične električne uređaje koji prave buku. Slika se deli. Verovatno lokacija antene nije dobra. Upotreba visoke antene može poboljšati kvalitet slike.

Televizor ne reaguje na daljinski upravljač

Usmerite daljinski upravljač direktno na senzor signala na TV-u. Ako televizor i dalje ne reaguje proverite da li ste skinuli folije iz daljinskog upravljača. Takođe proverite da li ste ispravno postavili baterije. Zamenite baterije novim.

Nema ulazni video signal (PC režim)

Proverite da li je kabl video signala ispravno povezan sa VGA ulazom. Provrte da li je kabl za video signal negde presavijen.

Ekran je svetao ili taman (PC režim)

Podesite kontrast ili osvetljenost iz glavnog menija.

Funkcija (PC režim) ne reaguje

Promenite postavku PC-a za kompatibilnu rezoluciju ekrana.

Prilikom povezivanje preko RCA se pojavljuju linije

Koristite kvalitetniji kabl za povezivanje

Problemi i dalje postoje

Izvučite kabl za napajanje i sačekajte oko 30 sekundi, onda ga ponovo postavite. Ako postoji neki problem sa televizorom, ne pokušavajte da ga popravite sami. Obratite se specijalizovanom servisu ili ovlašćenom uvozniku.

SPECIFIKACIJE

Veličina ekrana	Potrošnja energije	Dodaci
16"	24W	Uputstvo za upotrebu x1 Daljinski upravljač x1 Naponski kabl x1 AAA baterije x2
19"	36W	
22"	36W	
24"	36W	
28"	36W	
32"	56W	
39"/40"	70W	
42"	70W	
43"	80W	
50"	108W	
55"	135W	
65"	195W	



Manufactured under license from Dolby Laboratories. Dolby, Dolby Audio, Pro logic, and the double-D symbol are trademarks of Dolby Laboratories.

1. Dugme za uključivanje ili režim mirovanja
2. Dugme za stopiranje zvuka. Pritisnite dugme ponovo kako biste uključili zvuk opet. Možete da pritisnete i dugme VOL+.
3. 0-9 : Izaberite i pritisnite digitalna dugmad od 1-9 kako biste promijenili kanal dok gledate televiziju..
4. MTS: Pritisnite da tražite NICAM režim
5. MENU: Omogućava Vam da upravljate menijem ekrana.
6. SOURCE: Otvora glavni meni, pritisnite da vidite izvore signala.
7. ▾ / ▲ / ◀ / ▶ ENTER: Dozvoljava Vam da se krećete kroz meni i da prilagođavate sistemska podešavanja.
8. EXIT: Izlaz iz menija i podmenija i isključivanje zadate funkcije kod kanala.
9. DISPLAY: Pritisnite za prikaz informacija o izvoru ili o kanalu.
10. VOL+ / Vol-: Pritisnite za smanjivanje ili povećanje nivoa zvuka.
11. TV/RADIO: Prebacivanje iz TV moda u Radio i obrnuto.
12. GUIDE: Pokretanje elektronskog vodiča i prelaz u PVR ili medija plejer režim.
13. CANCEL: Kada ste izabrali stranu u tekstualnom režimu i sada neće da se otvori, možete pritisnuti ovo dugme da otkažete komandu i vratite se u TV funkciju. Kada je željena strana pronađena i otvorena pojaviće se numerisana u gornjem uglu ekrana. Pritisnite da biste se vratili na stranicu za tekst koji želite da otvorite. Prethodno poglavlje u PVR ili Media Player modu
14. INDEX: Zatraži Index stranicu u Teletekst modu.
15. Isključenje reprodukcije u PVR modu ili Media Player modu.
16. SIZE: Promena veličine prikaza u Teletekst modu.
17. REVEAL: Otkrivanje i sakrivanje reči.
18. Dugmići u boji: uključuju teletekst u analognom modu.
19. CH+/CH-: Pritisnite za odabir prethodnog/sledećeg kanala
20. FAV : pritisnite da otvorite listu omiljenih kanala, zatim možete odabrati Vaš omiljeni kanal.
21. ASPECT: Promena formata slike
22. Brzo premotavanje u PVR modu ili Media Player modu.
23. SUB PG: Pristup podstranici
Prelazak na sledeće poglavlje u PVR ili Media Player modu.
24. SUBTITLE: Za podešavanje jezika u DTV meniju.
25. HOLD: Uključenje i isključenje prikaza trenutne stranice.
26. TTX : Uključenje i isključenje Teletekst moda
27. RECLIST: Prikazuje listu snimljenog programa
28. REC: Započinjanje snimanja u PVR modu

OPREZ: Baterije koje se nalaze u daljinskom upravljaču se ne smiju izlagati toploti. Na primer: suncu, vatri i slično..

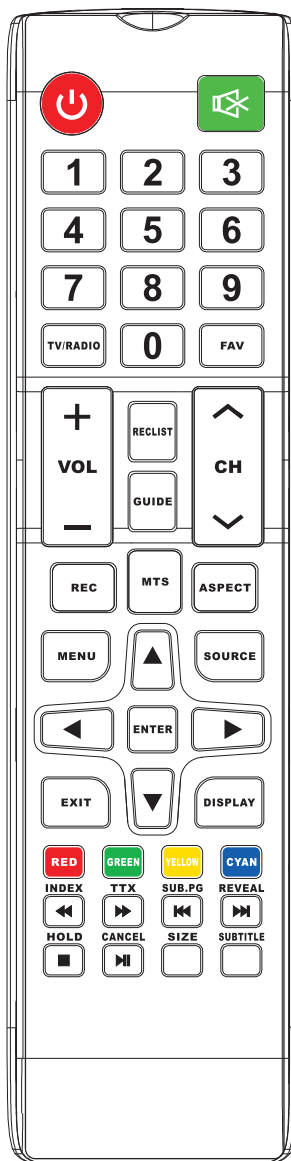



Nadamo se da ste pažljivo pročitali uputstva i da ćete ih se pridržavati.
Za više informacija o FOX uređajima posetite našu internet stranicu:

www.foxelectronics.rs