

 Pantone 1655C

 Black



FOX

Electronics Corporation Limited

MODEL:

LED TELEVIZORI



HDMI[®]
HIGH DEFINITION MULTIMEDIA INTERFACE

UPUTSTVO ZA UPOTREBU

Molimo Vas da detaljno proučite ovo uputstvo pre upotrebe televizora i da ga čuvate radi kasnije upotrebe





SAFETY INSTRUCTIONS

IMPORTANT SAFETY INSTRUCTIONS

WARNING

- TO PREVENT FIRE OR SHOCK HAZARD, DO NOT USE AN EXTENSION CORD, RECEPTACLE OR OTHER OUTLET UNLESS THE BLADES CAN BE TO PREVENT BLADE EXPOSURE.
- TO PREVENT FIRE OR SHOCK HAZARD, DO NOT EXPOSE THIS APPLIANCE TO RAIN OR MOISTURE.

 <p>This lightning flash with arrowhead symbol in an equilateral triangle alerts users to the presence of uninsulated dangerous voltage within the products enclosure that may be of sufficient magnitude to constitute a risk of electric shock to persons.</p>	<h4>CAUTION</h4> <p>RISK OF ELECTRIC SHOCK DO NOT OPEN</p> <p>Warning: To reduce the risk of electric shock, do not remove cover (or back). No user serviceable parts inside. Refer servicing to qualified service personnel.</p>	 <p>The exclamation mark within an equilateral triangle alerts users to the presence of important operating and maintenance (servicing) instructions in the literature accompanying the appliance.</p>
---	--	--

This appliance should not be exposed to water and no object filled with liquid such as a vase should be placed on the unit.

CAUTION

- Danger of explosion if batteries are incorrectly replaced.
- Replace with only equivalent type of battery.
- Do not expose battery to direct sunlight or any other source of heat.
- Ensure proper disposal of used batteries.
- To reduce the risk of electric shock, do not perform any servicing other than what is mentioned in the operating manual.
- There are no user-serviceable parts inside the TV; do not open the TV casing.

IMPORTANT INFORMATION

If a television is not positioned in a sufficiently stable location, it can be potentially hazardous due to falling. Many injuries, particularly to children, can be avoided by taking simple precautions such as:

- Using cabinets or stands recommended by the manufacturer of the television.
- Only using furniture that can safely support the television.
- Ensuring the television is not overhanging the edge of the supporting furniture.
- Not placing the television on tall furniture (for example, cupboards or bookcases) without anchoring both the furniture and the television to a suitable support.
- Not standing the televisions on cloth or other materials placed between the television and supporting furniture.
- Educating children about the dangers of climbing on furniture to reach the television or its controls.



Safe installation

Use the belt fixing the television to facilitate restraining the television from toping forward.



SAFETY INSTRUCTIONS

1. **Read Instructions** - All the safety and operating instructions should be read before the appliance is operated.
2. **Retain Instructions** - The safety and operating instructions should be retained for future reference.
3. **Heed Warnings** - All warnings on the appliance and in the operating instructions should be adhered to.
4. **Follow Instructions** - All operating instructions should be followed.



5. **Water and Moisture** - The appliance should not be used near water.
6. **Cart and Stands** - The appliance should only be used with a cart or stand that is recommended by the manufacturer.
7. **Wall or Ceiling Mounting** - The appliance should be mounted to a wall or ceiling only as recommended by the manufacturer.
8. **Ventilation** - The appliance should be well situated so that its location or position does not interfere with its proper ventilation.
9. **Heat** - This appliance should be placed away from heat sources such as radiators, heat registers and stoves.
10. **Power Sources** - The appliance should only be connected to a power supply as described in the operating instructions or as marked on the appliance.
11. **Grounding or Polarization** - Precautions should be taken.
12. **Power Cord Protection** - Power supply cord should be routed so that it is not likely to be walked on, pinched by items placed upon it against the cord and its end.
13. **Cleaning** - The appliance should be cleaned only as recommended by the manufacturer.
14. **Power Line** - An outdoor antenna should be located away from power lines.
15. **Outdoor Antenna Grounding** - If an outside antenna is connected to the receiver, the antenna system must be grounded so as to provide against voltages and built-up static charges.
16. **Non-use Periods** - The power cord of the appliance should be unplugged from the outlet when left unused for a long period of time.
17. **Object and Liquid Entry** - Care should be taken so that objects do not fall, and liquids are not spilled into the enclosure through openings.
18. **Conditions requiring Service** - The appliance should be serviced by qualified service personnel when:
 - The power-supply cord or the plug has been damaged.
 - Objects have fallen on or liquid has been spilled into the appliance.
 - The appliance has been exposed to rain.
 - The appliance does not appear to operate normally or exhibits a marked change in performance.
19. The ventilation should not be impeded by covering the ventilation opening with items, such as newspapers, table-cloths, curtains, etc.
No naked flame sources, such as lighted candles, should be placed on the apparatus.
The apparatus shall be connected to mains socket outlet with a protective earthing connection.
The appliance coupler regard as disconnection device, the disconnect device shall remain readily operable.

SAFETY INSTRUCTIONS

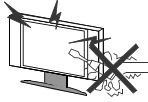

Warning

High voltages are used in the operating of this product. Do not remove the back cover of the cabinet. Refer servicing to qualified service personnel.

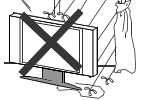

Warning

To prevent fire or electrical shock hazard, do not expose the main unit to rain or moisture.

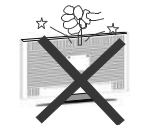

Warning

Do not drop or push objects into television cabinet slots or openings. Never spill any kind of liquid on the television receiver.

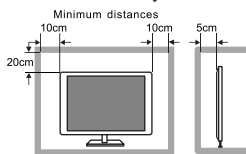

Caution

If the television is to be built into a compartment or similarly enclosed, the minimum distances must be maintained.

Heat built up can reduce the service life of your television, and can also be dangerous.



Caution

Never stand on, lean on, push suddenly the product or its stand.

You should pay special attention to children.

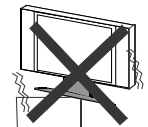

Caution

Do not place the main unit on an unstable cart stand, shelf or table.

Serious injury to an individual, and damage to the television, may result should it fall.

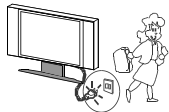

Caution

When the product is not used for an extended period of time, it is advisable to disconnect the AC power cord from the AC outlet.

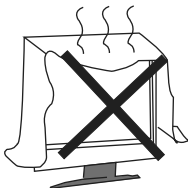

Caution

Avoid exposing the main unit to direct sunlight and other sources of heat. Do not position television receiver directly on other products which give off heat. E.g. Video cassette players, audio amplifiers. Do not block the ventilation holes in the back cover. Ventilation is essential to prevent electrical failure. Do not squash power supply cord under the main unit.



Caution

The panel used in this product is made of glass. It can break when the product is dropped or applied with force.

Individuals should execute caution when dealing with broken glass should the panel break.



CONTENTS

SAFETY INSTRUCTIONS

..... 1-3

DESCRIPTION OF CONTROL KEYS & CONNECTORS

..... 5-6

OPERATION OF REMOTE CONTROL

..... 7-8

CONNECTIONS

..... 9

AUTOMATIC PRESET CHANNEL

..... 10

OPERATION OF FUNCTION MENU

..... 11-16

TROUBLE SHOOTING GUIDE

..... 17

SPECIFICATIONS

..... 18

DESCRIPTION OF CONTROL KEYS & CONNECTORS

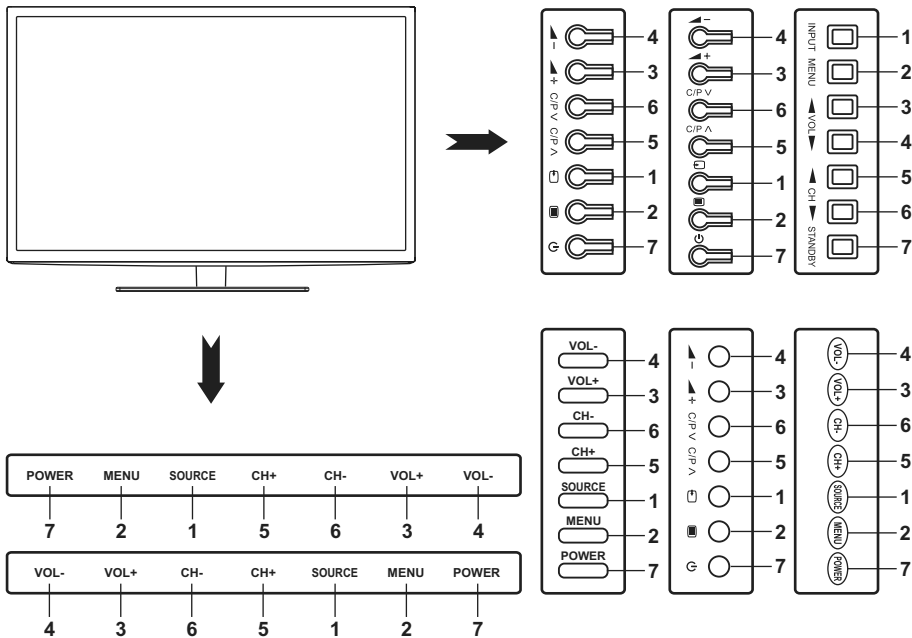

1. SOURCE BUTTON

To switch SOURCE mode by pressing the SOURCE button on the remote control, and press the Up or Down arrow button to select items, then press the OK button to confirm.

2. MENU BUTTON

To select menu.

3. VOLUME UP BUTTON

To increase the sound volume level.

4. VOLUME DOWN BUTTON

To decrease the sound volume level.

5. PROGRAM UP BUTTON

To select the next higher programme number.

6. PROGRAM DOWN BUTTON

To select the next lower programme number.

7. STANDBY BUTTON

Switch On/Off the TV when at standby mode.

DESCRIPTION OF CONTROL KEYS & CONNECTORS

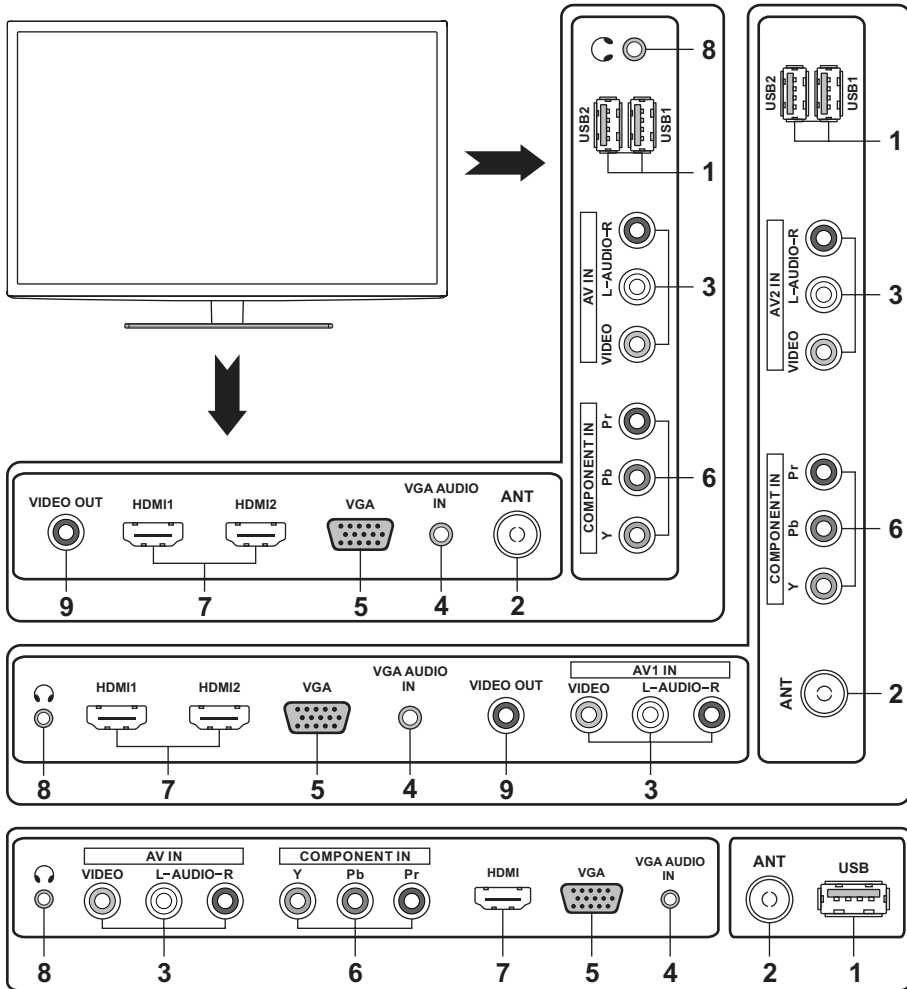

1. **USB / USB1 / USB2 IN** (USB input port)
2. **TERMINAL ANTENNA (75 OHM)** TV signal input port.
3. **AV/AV1/AV2 IN** (AV/AV1/AV2 input port)
4. **VGA AUDIO IN** (VGA audio input port)
5. **VGA** (RGB signal input port)
6. **COMPONENT IN** (YPbPr signal input port)
7. **HDMI / HDMI1 / HDMI2** (HDMI signal input port)
8. **EARPHONE OUT** (Earphone output port)
9. **VIDEO OUT** (VIDEO output port)

OPERATION OF REMOTE CONTROL

The remote controller cannot be used unless it is within the receivable range. Before you use the remote control, please make sure there's no obstacle between the remote control and the receiver:

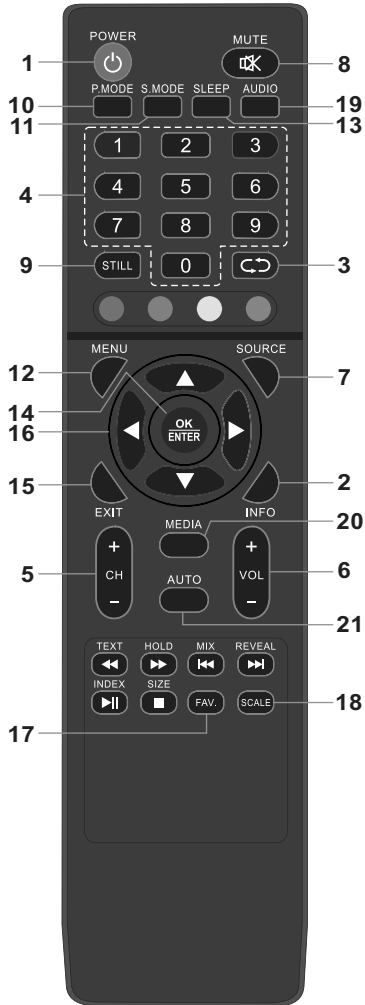

1. POWER BUTTON

Switch On/Off the TV when at standby mode.

2. INFO BUTTON

Display the source and channel information.

3. RETURN BUTTON

Press the button to toggle between the current and the previous program you were viewing.

4. NUMBER BUTTONS

Press these buttons to select the TV program you want to enter or input password.

5. CH+/CH- BUTTON

Press two buttons to directly to adjust the TV program.

6. VOL+/VOL- BUTTON

Press two buttons to directly to turn up or turn down the sound volume level.

7. SOURCE BUTTON

Press the button display Source menu.

8. MUTE BUTTON

Press the button to turn off the volume. Press it again to turn on the volume.

9. STILL BUTTON

Freeze picture..

10. P.MODE BUTTON

Picture effect selection.

11. S.MODE BUTTON

Sound effect selection.

12. MENU BUTTON

Press the button to open the main menu, press again or use Exit to close.

13. SLEEP BUTTON

Press the button to set up the TV auto turn off time.

14. OK/ENTER BUTTON

Press the button to confirm or enter sub menus.

15. EXIT BUTTON

Press the button to exit.

16. UP, DOWN, LEFT, RIGHT ARROW BUTTONS

Press these buttons to select or adjust the desired item on the TV menu.

17. FAV. BUTTON

Display favourite of program list.

18. SCALE BUTTON

Press the button to display and select available aspect modes.

19. AUDIO BUTTON (Optional)

Press the button to display and select different TV Audio systems or Language.

20. MEDIA BUTTON

Directly into the USB mode.

21. AUTO BUTTON

In VGA mode, picture position automatic correction .

OPERATION OF REMOTE CONTROL

TELETEXT FUNCTION (Optional)

1) TEXT BUTTON

Press the TEXT button to change the viewing from TV to Teletext if TV stations in your local have teletext broadcasting.

2) REVEAL BUTTON

This is a toggle function key to display hidden characters.

3) MIX BUTTON

This is a toggle function button to display TV picture and teletext together or teletext only.

4) RED/GREEN/YELLOW/BLUE BUTTONS

These 4 Colour keys in teletext mode can quickly enter the pre-captured teletext pages.

5) ▲ / ▼ BUTTON

These keys can be used as a page up/down key in teletext mode.

6) 0, 1, 2, ..., 9 BUTTON

Using the 0, 1, 2, ..., 9 keys, the required Teletext pages are selected.

7) HOLD BUTTON

Some Teletext information is contained on more than one page, the pages automatically changing after a given reading time. Press the HOLD key to stop the page changing. Press the HOLD key again to allow the page to change.

8) INDEX BUTTON

Press the INDEX key to view Index page in teletext mode.

9) SIZE BUTTON

This key is to expand character size and display half teletext page. Each press will display upper ... tower Normal page.

USB FUNCTION (Optional)

1) ◀ / ▶ BUTTON

Skip a scene or music.

2) ◀◀ / ▶▶ BUTTON

Go back to the previous or skip to the next.

3) ⏸ BUTTON

Play / Pause.

4) ■ BUTTON

Stop playback.

Note:

A USB device must already be connected.

BATTERY INSTALLATION OF REMOTE CONTROL UNIT

1. Open the battery compartment cover.
2. Insert two 'AAA' (pencil size) 1.5V batteries. Make sure the polarity (+ or -) of the batteries matches the polarity marks inside the unit.
3. Close the battery compartment cover.

Note:

- Recommend use alkaline type batteries.
- The life time of the batteries may last up to one year, depending on how often the remote control is used. For the best performance, the batteries should be replaced on a yearly basis, or when remote operation becomes erratic.
- Be sure to place the batteries in the correct direction, as shown left.
- Do not mix old and new batteries, or different types.
- Old batteries may leak chemical and damage the remote control. Always remove batteries as soon as they become weak.

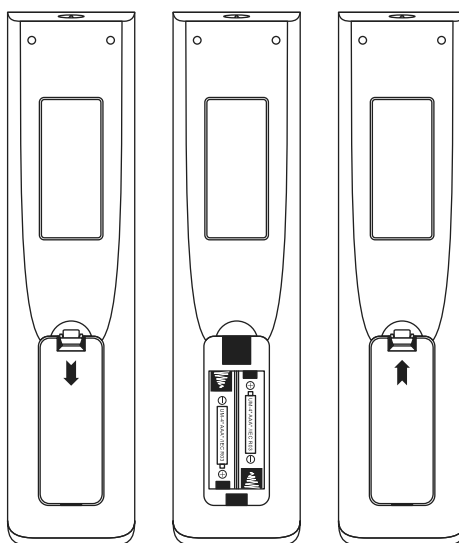

CONNECTIONS

INSTALLATION OF ANTENNA

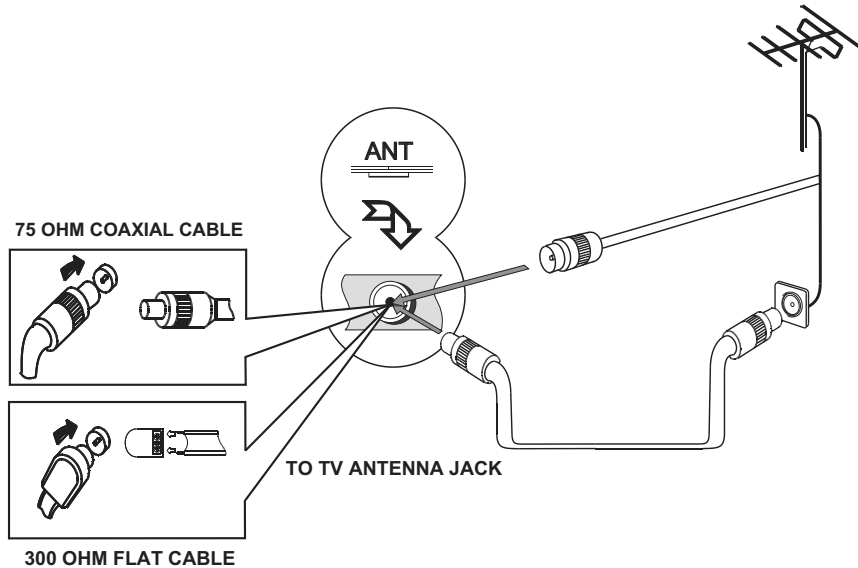

Connect the 75 OHM coaxial cable from the antenna to the antenna jack on the rear panel, as shown above.

Note:

- For better reception, especially in outlying area or where ghost or interference happens, an external roof-mounted antenna is recommended.
- For UHF TV reception, use the specified UHF antenna. Consult the local sale dealer.
- When using 300 OHM flat cable, a 300 OHM - 75 OHM adapter should be adopted for a proper connection to the antenna jack.

POWER CONNECTION

- Plug the AC cord into an AC outlet.
- Press the Power button on the remote control to turn on, press the Power button again to standby.

Note:

- This unit should be operated from a household AC 100-240V~ 50/60Hz.
- When you disconnect the power supply cord, pull it out by the plug. Never pull the cord itself.

CAUTIONS:

During a power outage, the TV should be unplugged from the AC outlet. To conserve energy the TV should be unplugged from the AC outlet if not being used for a prolonged period of time.

AUTOMATIC PRESET CHANNEL

1. Connect your cable or Antenna to the Terminal Antenna Jack.
2. In TV mode, press the Menu button on the TV set or on the remote control.
3. Press the Left or Right arrow button on the remote control to select Channel menu, then press the Up or Down arrow button to select Auto Tuning.
4. Press the OK or Right arrow button to begin searching on the remote control and the TV will find all available channels. In the course of the auto searching, press 'MENU' button to display 'Do you want to exit tuning? ◀ Yes No ▶', then press Left arrow button to exit searching.

Note:

- Please be patient as it will take a few minutes to find all channels.

Now You are Ready to Watch TV

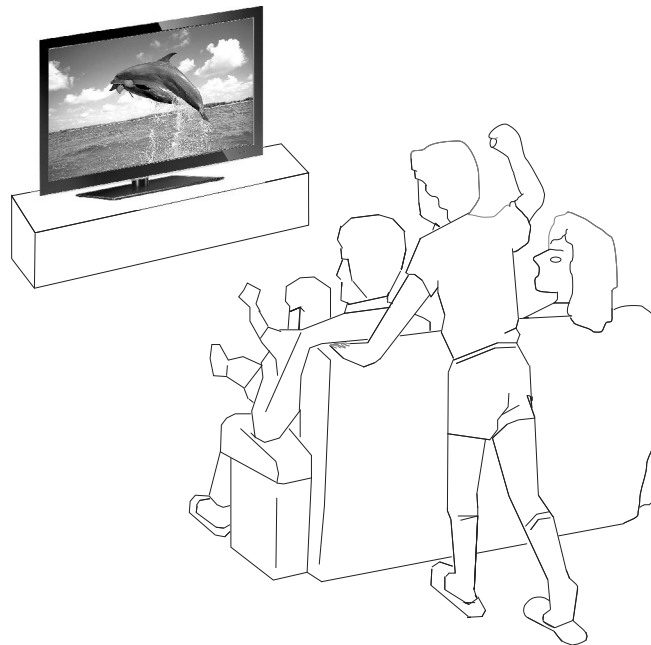

OPERATION OF FUNCTION MENU

MAIN MENU OPERATION

Press the MENU button on the remote control to display main menu. Shown as below:

Note:

When an item in Menu is displayed as gray, it means that the item is not available or can not be adjusted with the current setup.

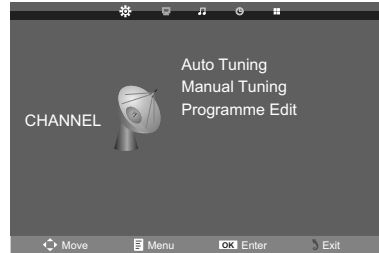

PICTURE MENU OPERATION

Press the Left or Right arrow button to select Picture menu. Shown as below:

1. Picture Mode Setting

Press the Up or Down arrow button to select Picture Mode item, then press the OK button to enter Picture Mode submenu, then press the Up or Down arrow button to select Standard, Mild, User or Dynamic, and press the OK button to confirm. Press the Menu button to return to the previous menu.

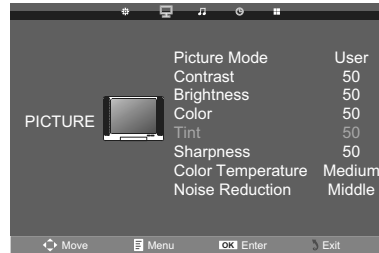

2. Contrast/Brightness/Color/Tint/Sharpness Adjustment

Press the Up or Down arrow button to select Contrast, Brightness, Color, Tint or Sharpness item, then press the Left or Right arrow button in order to decrease or increase Contrast, Brightness, Color, Tint or Sharpness. Press the Menu button to return to the previous menu.

3. Color Temperature Setting

Press the Up or Down arrow button to select Color Temperature item, then press the OK button to enter Color Temperature submenu, then press the Up or Down button to select Cool, Medium or Warm, and press the OK button to confirm. Press the Menu button to return to the previous menu.

4. Noise Reduction Setting

Press the Up or Down arrow button to select Noise Reduction item, then press the OK button to enter Noise Reduction submenu, then press the Up or Down button to select Off, Low, Middle or High, and press the OK button to confirm. Press the Menu button to return to the previous menu.

SOUND MENU OPERATION

Press the Left or Right arrow button to select Sound menu. Shown as Right:

1. Sound Mode Setting

Press the Up or Down arrow button to select Sound Mode item, then press the OK button to enter Sound Mode submenu, then press the Up or Down arrow button to select Standard, Music, Movie, Sports or User, and press the OK button to confirm. Press the Menu button to return to the previous menu.

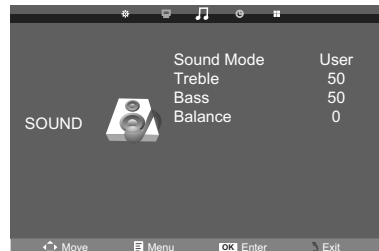

OPERATION OF FUNCTION MENU

2. Treble/Bass Adjustment

Press the Up or Down arrow button to select Treble or Bass item, then press the Left or Right arrow button in order to decrease or increase Treble or Bass. Press the Menu button to return to the previous menu.

3. Balance Adjustment

Press the Up or Down arrow button to select Balance item, then press the Left or Right arrow button in order to adjust left and right track. Press the Menu button to return to the previous menu.

TIME MENU OPERATION

Press the Left or Right arrow button to select Time menu. Shown as below:

1. Clock Setting

Press the Up or Down arrow button to select Clock item, then press the OK button to enter Clock submenu, and press the Up or Down arrow button to select items, press the Left or Right arrow button to adjust. Press the Menu button to return to the previous menu.

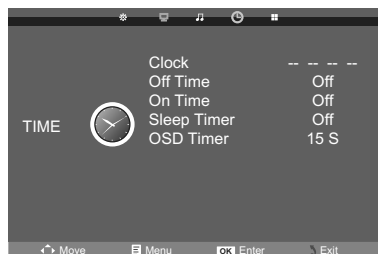

2. Off Time Setting

Press the Up or Down arrow button to select Off Time item, then press the OK button to enter Off Time submenu, and press the Up or Down arrow button to select items, press the Left or Right arrow button to adjust. Press the Menu button to return to the previous menu.

3. On Time Setting

Press the Up or Down arrow button to select On Time item, then press the OK button to enter On Time submenu, and press the Up or Down arrow button to select items, press the Left or Right arrow button to adjust. Press the Menu button to return to the previous menu.

4. Sleep Timer Setting

Press the Up or Down arrow button to select Sleep Timer item, then press the OK button to enter Sleep Timer submenu, and press the Up or Down arrow button to select Off, 10min, 20min, 30min, 60min, 90min, 120min, 180min or 240min, and press the OK button to confirm. Press the Menu button to return to the previous menu.

5. OSD Timer Setting

Press the Up or Down arrow button to select OSD Timer item, then press the OK button to enter OSD Timer submenu, and press the Up or Down arrow button to select 5 S, 10 S, 15 S, 20 S, 25 S or 30 S, and press the OK button to confirm. Press the Menu button to return to the previous menu.

OPTION MENU OPERATION

Press the Left or Right arrow button to select Option menu. Shown as below:

1. OSD Language Setting

Press the Up or Down arrow button to select OSD Language item, then press the OK button to enter OSD Language submenu, and press the Left or Right arrow button to select different languages, press the OK button to confirm. Press the Menu button to return to the previous menu.



2. TTX Language Setting (Optional)

Press the Up or Down arrow button to select TTX Language item, then press the OK button to enter TTX Language submenu, and press the Up or Down arrow button to select West, East, Russian, Arabic or Farsi, press the OK button to confirm. Press the Menu button to return to the previous menu.

3. Scale Setting

Press the Up or Down arrow button to select Scale item, then press the OK button to enter Scale submenu, and press the Up or Down arrow button to select available aspect modes. Press the Menu button to return to the previous menu.

OPERATION OF FUNCTION MENU

4. Blue Screen/Keyboard Lock Setting

Press the Up or Down arrow button to select Blue Screen or Keyboard Lock items, and press the Left or Right arrow button to select On or Off. Press the Menu button to return to the previous menu.

5. Reset

Press the Up or Down arrow button to select Reset item, and press the OK button to display 'Are you sure? ◀ Yes No ▶', then press the Left or Right arrow button to Yes or No, press the Menu button to return to the previous menu.

6. Software Update(USB)

Press the Up or Down arrow button to select Software Update (USB) item, and press the OK button to confirm.

Note: User only on advice from Customer Support.

MENU OPERATION IN TV MODE

CHANNEL MENU OPERATION

Press the Left or Right arrow button to select Channel menu. Shown as below:

1. Auto Tuning

Press the Up or Down arrow button to select Auto Tuning item, then press OK button to begin searching and the TV will find all available channels. In the course of the auto searching, press 'MENU' button to display 'Do you want to exit tuning? ◀ Yes No ▶', then press Left arrow button to exit searching.

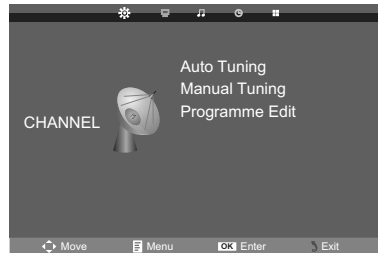

2. Manual Tuning

Press the Up or Down arrow button to select Manual Tuning item, then press the OK button to enter Manual Tuning submenu, and press the Up or Down arrow button Current CH, Color System, Sound System, Fine-Tune or AFC items, press the Left or Right arrow button to adjust. Press the Up or Down arrow button to select Search item, then press the Left arrow button to search through channels from high to low. Until found a channel to stop searching. Press the Right arrow button to search through channels from low to high, Until found a channel to stop searching. Press the Menu button to return to the previous menu.

3. Programme Edit

Press the Up or Down arrow button to select Programme Edit item, then press the OK button to enter Programme Edit submenu, and press the Up or Down arrow button to select items, press the Red button to delete the channel. Press the Green button to rename the channel. Press the Yellow button to move the channel. Press the Blue button to skip the channel. Press the FAV. button to set the favourite channel. Press the Menu button to return to the previous menu.

MENU OPERATION IN VGA MODE

VGA MENU OPERATION

Press the Left or Right arrow button to select Screen menu. Shown as Right:

1. Auto Adjust

Press the Up or Down arrow button to select Auto Adjust item, then press the OK button to confirm.

2. Horizontal Pos./Vertical Pos./Clock/Phase Adjustment

Press the Up or Down arrow button to select Horizontal Pos., Vertical Pos., Clock or Phase items. Press the Left or Right arrow button to adjust Horizontal Pos., Vertical Pos., Clock or Phase. Press the Menu button to return to the previous menu.



OPERATION OF FUNCTION MENU

OPERATION OF USB FUNCTION

Press the Source button to display Source menu, and press the Up or Down arrow button to select Media (Media1 or Media2) item, then press the OK button to enter the interface, Shown as right:

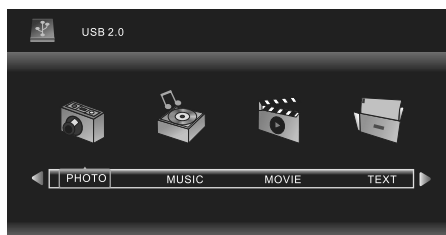

Press the Left or Right arrow button to select PHOTO, MUSIC, MOVIE or TEXT icons, then press the OK button to confirm and enter the next menu. Shown as right:



I. Photo

- 1) Press the Left or Right button to select the 'PHOTO' icons.
- 2) Press the OK button to enter the disk selection menu.
- 3) Press the Left or Right button to select disk to enter the submenu.
Press the ↶ button to return to the previous menu.
- 4) Press the Up, Down, Left or Right arrow button to highlight files. Press the OK button to select files (indicated with a checkmark) for selective playback. Press the Red button, you will enter the submenu to delete the file.
- 5) Press the Up, Down, Left or Right button to preview the file, shown as below:
- 6) Press the Play button to play photo slideshow (of checkmarked files; if no files are ticked, all pictures will play), press the OK button to display menu.



According to menu display, press the Left or Right arrow button to function items, then press the OK button to confirm. Press the Exit button to exit.



OPERATION OF FUNCTION MENU

2. Music

- 1) Press the Left or Right button to select the 'MUSIC' icons.
- 2) Press the OK button to enter the music interface, press the Up, Down, Left or Right arrow button to preview the music. Shown as right:
- 3) Press the Play button into music player and playing the selected music, Shown as right:

Pause

Press the Pause button to pause the playing music.

Play

Press the Play button to play the music.

FB

Press the FB button to fast reverse among 2X, 4X, 8X and 16X modes.

FF

Press the FF button to fast forward among 2X, 4X, 8X and 16X modes.

PREV.

Press the Prev. button to skip to previous track.

NEXT

Press the Next button to skip to next track.

Stop

Press the Stop button to stop and return.

Repeat All

Press the  button to repeat play music ( Repeat 1,  Repeat All,  Repeat None).

Mute

Press the  button to turn off the sound.

Playlist

Press the Playlist button to display play list.

Info.

Press the Info. button to display the music information.

Goto Time

Press the Goto Time button to setup play time.

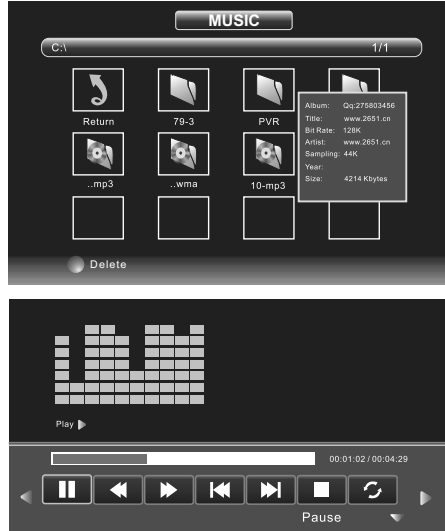

3. Movie

- 1) Press the Left or Right button to select the 'MOVIE' icons.
- 2) Press the OK button to enter the movie interface, press the Up, Down, Left or Right arrow button to preview the files. Shown as right:
- 3) Press the Play button to play the movie. Press the OK button to display menu. Press the Play button once more to play the movie full-screen. Press the Pause button to pause the playing movie. Press the Prev. or Next button to skip the backward or forward. Press the FB or FF button to fast reverse or fast forward. Press the Stop or Exit button to return.



OPERATION OF FUNCTION MENU

4. Text

- 1) Press the Left or Right button to select the 'TEXT' icons.
- 2) Press the OK button to enter the text interface, press the Up, Down, Left or Right arrow button to preview the files. Shown as right:
- 3) Press the Play button to open and play the file, press the OK button to display menu. Shown as right:

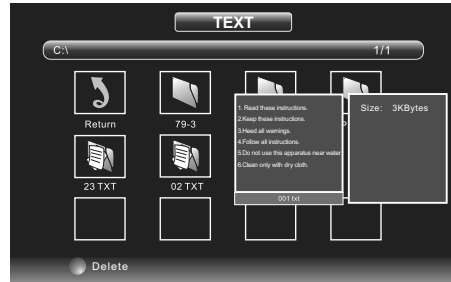

According to menu display, press the Left or Right arrow button to function items, then press the OK button to confirm. Press the Exit button to exit.

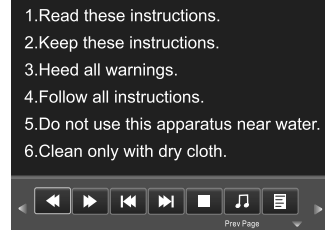

TROUBLE SHOOTING GUIDE

Many apparent malfunctions are caused slight misadjustments of the regular controls of your unit or equally simple causes. If any difficulty arises through normal use of your unit, check the list of common problems in the list below.

If the problem persists, unplug your unit and contact your dealer.

SYMPTOM	METHODS OF CHECKING OR ADJUSTING
No picture or sound	Check the AC plug is in the socket. Check house circuit breaker is in the ON position.
Picture normal but no sound	Check that the volume is not at its minimum setting or on MUTE.
Remote control not working	Check that TV set power is ON. Check batteries are operational and inserted correctly. Make sure infrared receiving window on TV is not exposed to strong lighting or blocked in any way.
Cannot receive any TV signal	Ensure SOURCE switch is set to TV. Check aerial location and connection. Re-check your tuning method.
No program signals output from external source	Check SOURCE button to make sure it is in the correct position for reception.
Contrast and brightness problems	Make necessary adjustments to relevant settings.
Intermittent poor contrast and colour fading on all channels	Check aerial positioning
Dotted lines or stripes appear on screen	There may be Interference from another electrical product. Move appliance if it persists.
Snow on screen	Check aerial for broken circuit, loose connection or any visible damage.
Double images or 'ghosting'	Check aerial location and direction - strong winds may cause it to move. Also check whether mountains or tall buildings may be the problem. Minor adjustment of the direction of your antenna should keep the ghosting to a minimum.

Note: External rooftop/antenna adjustment should be left to a suitably qualified person.

SPECIFICATIONS

Aspect Ratio	16 : 9
System	PAL/SECAM BG, DK, I NTSC Playback
Base impedance	75 Ω (Unbalance)
Receiving TV Band	All Channels Receiveable
AC Supply Voltage	100-240V~ 50/60Hz

Note: Part of the design and the specification may be changed without prior notice.

INFRA-RED REMOTE CONTROL

Features: Full function remote control

Effective Distance Power: 8 metres

Power Supply: DC 3V (Two batteries, size AAA, recommend use alkaline type batteries)

Media Play

When select the media source mode and input your USB, you can play the USB.

There are 4 items as following: PHOTO, MUSIC, MOVIE, TEXT.

The supported file format of media playing:

File Type	Supported File Format	File Name
Photo	BMP / JPEG	.bmp / .jpeg
Audio	MP3	.mp3
Video	MPEG1 / MPEG2	.mpg / .dat / .vob / .avi
Text	TXT	.txt

Note:

Not compatible with HDD. The file you played needs license (customer should check this point) or it will not be played.

 Pantone 1655C

 Black



FOX

Electronics Corporation Limited

MODEL:

LED TELEVIZORI



HDMI[®]
HIGH DEFINITION MULTIMEDIA INTERFACE

UPUTSTVO ZA UPOTREBU

Molimo Vas da detaljno proučite ovo uputstvo pre upotrebe televizora i da ga čuvate radi kasnije upotrebe





BEZBEDNOSNA UPUTSTVA

VAŽNA BEZBEDNOSNA UPUTSTVA

UPOZORENJE

- KAKO BI SPREČILI OPASNOST OD POŽARA ILI STRUJNOG UDARA NE KORISTITE OŠTEĆEN PRODUŽNI KABL, RAZDELNIK ILI NEKI DRUGI PRIKLJUČAK ZA STRUJU.
- KAKO BI SPREČILI OPASNOST OD POŽARA ILI STRUJNOG UDARA NE IZLAŽITE OVAJ APARAT VLAZI ILI KIŠI.

 <p>Znak munje unutar jednokrakog trougla upozorava korisnike na opasne i neizlovene delove pod naponom unutar uređaja koji može biti dovoljne jačine da predstavlja opasnost od strujnog udara.</p>	<p>CAUTION</p> <p>RISK OF ELECTRIC SHOCK DO NOT OPEN</p> <p>UPOZORENJE: Kako bi umanjili rizik od strujnog udara ne skidajte poklopac (ili zadnji deo). Unutar uređaja nema delova koje možete sami servisirati. Obratite se kvalifikovanim serviserima.</p>	 <p>Znak uzvika unutar jednokrakog trougla obaveštava korisnike na postojanje važnih uputstava za upotrebu, kao i uputstava o održavanju u literaturi koja prati proizvod.</p>
---	--	--

Uređaj ne bi trebali da izlažete vodi, takođe na uređaj ne stavljajte posude ispunjene tečnošću.

OPREZ

- Opasnost od eksplozije ako baterije nisu pravilno promenjene.
- Zamenu izvršiti samo sa odgovarajućim tipom baterije.
- Ne izlažite baterije direktnom suncu ili izvoru toplote.
- Osigurajte odgovarajuće odlaganje istrošenih baterija.
- Kako bi smanjili rizik od strujnog udara održavajte proizvod samo kako je opisano u korisničkom uputstvu.
- Unutar proizvoda nema delova koje korisnik može sam servisirati. Ne otvarajte kućište proizvoda.

VAŽNE INFORMACIJE

Ako televizor nije postavljen na dovoljno stabilnu površinu može potencijalno biti opasan usred pada. Mnoge povrede, naročito dece, mogu se izbeći preuzimanjem jednostavnih mera kao što su:

- Korišćenje kabineta i stalaka preporučenih od strane proizvođača televizora.
- Korišćenjem nameštaja koji će biti bezbedna potpora za televizor.
- Ne stavljati televizor na visoki nameštaj kao što su kredenc ili orman za knjige, bez učvršćivanja istih za odgovarajuću potporu.
- Ne stavljati tkaninu ili bilo koji drugi material između televizora i nameštaja na koji je postavljen.
- Upoznajite decu sa opasnostima penjanja na nameštaj kako bi dohvatili televizor.



Sigurnosna montaža

Koristite pojas kako bi osigurali da se televizor ne prevrne unapred.



BEZBEDNOSNA UPUTSTVA

1. **Pročitajte uputstva** – Pre nego što počnete da koristite uređaj pročitajte sva bezbednosna uputstva kao i uputstva za upotrebu uređaja.
2. **Upamtite uputstva** – Upamtite sva bezbednosna uputstva i uputstva za upotrebu uređaja radi buduće upotrebe.
3. **Obratite pažnju na upozorenja** – Pridržavajte se svih upozorenja koja se nalaze na uređaju kao i upozorenja koja se tiču upotrebe ovog proizvoda.
4. **Sledite uputstva** – Treba da sledite sva uputstva koja se tiču upotrebe uređaja.



5. **Voda i vlaga** – Ovaj uređaj ne koristite u blizini vode.
6. **Kolica i stalak** – Uređaj koristiti samo sa kolicima i stalcima koji su preporučeni od strane proizvođača.
7. **Montaža na zid ili plafon** – Uređaj montirati na zid ili plafon samo u skladu sa uputstvima proizvođača.
8. **Ventilacija** – Uređaj postaviti tako da njegova lokacija i položaj ne ometaju njegovu ventilaciju.
9. **Toplota** – Uređaj postaviti dalje od izvora toplote kao što su radijatori, šporeti...
10. **Izvor napajanja** – Uređaj treba da bude povezan sa izvorom napajanja samo kako je navedeno u uputstvu za upotrebu ili na uputstvima koja se nalaze na samom uređaju.
11. **Uzemljenje i polarizacija** – Preduzeti mere predostrožnosti.
12. **Kabl za napajanje i zaštita** – Kabl za napajanje treba da bude postavljen tako da je mala verovatnoća da se gazi i priklješti predmetima.
13. **Čišćenje** – Uređaj čistiti samo po uputstvu proizvođača.
14. **Dalekovod** – Postaviti spoljnu antenu dalje od dalekovoda i strujnih kablova.
15. **Spoljna antena i uzemljenje** – Ako je spoljna antena povezana sa uređajem, antenski sistem mora biti uzemljen kako bi pružio zaštitu od napona i nagomilanog statičkog elektriciteta.
16. **Period kada se uređaj ne koristi** – Kabl za napajanje uređaja isključiti iz utičnice ako se uređaj ne koristi duže vreme.
17. **Predmeti i prodor tečnosti** – Vodite računa da predmeti ne padaju na uređaj, kao i da ne bude poliven tečnošću.
18. **Slučajevi kada je potreban servis** – Uređaj treba servisirati kvalifikovano osoblje u sledećim slučajevima:
 - Kabl za napajanje ili utičnica su oštećeni.
 - Predmeti su pali na uređaj ili je na njega prosuta tečnost.
 - Uređaj je izložen kiši.
 - Uređaj ne radi normalno ili su nastale promene u performansama.
19. Ne prekrivati ventilacione otvore sa predmetima kao što su novine, milje, zavese i slično.
Ne stavljati izvore otvorenog plamena, kao što su sveće, na uređaj.
Uređaj priključiti isključivo u utičnicu sa uzemljenjem.

BEZBEDNOSNA UPUTSTVA



Upozorenje

Ovaj proizvod koristi visoki napon.
Ne skidajte poklopac uređaja. Prepustite servisiranje kvalifikovanom osoblju.



Upozorenje

Da bi izbegli požar ili strujni udar ne izlažite uređaj kiši ili vlazi.



Upozorenje

Ne pokušavajte da ugurate predmete u otvore uređaja. Ne polivajte uređaj sa tečnošću.

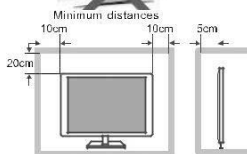

Oprez

Ako televizor postavljate u zatvoreni pregradak ili sličan prostor morate poštovati minimalnu udaljenost (slika levo). Nagomilana toplota može smanjiti vek trajanja vašeg televizora i takođe može biti opasna.



Oprez

Nikada nemojte stajati na, naslanati se na ili iznenada gurnuti uređaj ili postolje na kome se nalazi.
Obratite posebnu pažnju na decu.



Oprez

Ne postavljajte uređaj na nestabilna kolica, stalak, policu ili sto.
Moguće su povrede i oštećenje televizora kao rezultat njegovog pada.

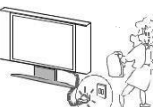

Oprez

Ako se proizvod ne koristi duže vreme preporučljivo je isključiti stjuni kabl iz izvora napajanja.

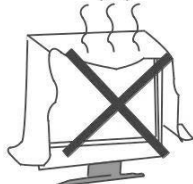

Oprez

Izbegavajte izlaganje uređaja direktnom suncu i drugim izvorima toplote. Ne postavljajte televizor na druge uređaje koji emituju toplot kao što su kasetofoni, video plejleri i audio pojačavači. Ne pokrivate ventilacione otvore na zadnjem delu uređaja. Ventilacija je neophodna kako bi se sprečio kvar. Nemojte prignječiti strujni kabl sa televizorom.



Oprez

Panel ovog proizvoda je od napravljen stakla. Može pući ako se televizor ispusti ili ako se na njega deluje silom. Korisnici treba da vode računa o polomljenom staklu u slučaju da panel pukne.



SADRŽAJ

BEZBEDNOSNA UPUTSTVA

1-3

OPIS KOMANDNIH DUGMIĆA I KONEKTORA

5-6

FUNKCIJE DALJINSKOG UPRAVLJAČA

7-8

KONEKCIJE

9

AUTOMATSKO PODEŠAVANJE KANALA

10

FUNKCIJE MENIJA

11-16

VODIČ ZA REŠAVANJE PROBLEMA

17

SPECIFIKACIJE

18

OPIS KOMANDNIH DUGMIĆA I KONEKTORA

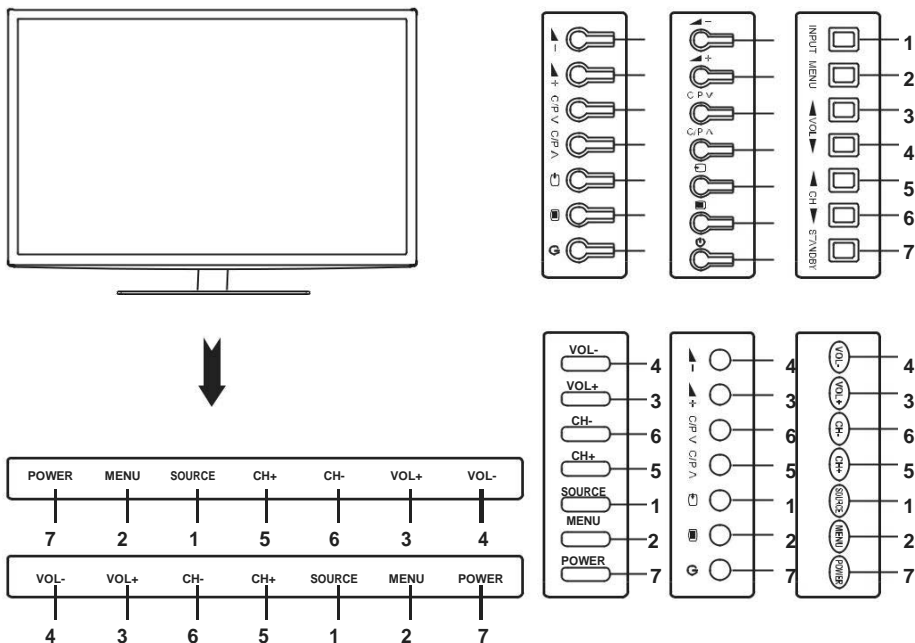

1. SOURCE DUGME

Kako bi izabrali izvor ulaznog signala pritisnite dugme SOURCE. Posle toga uz pomoć dugmića strelica gore ili dole na vašem daljinskom izaberite željenu opciju i sa dugmetom OK je potvrdite

2. MENU DUGME

Za otvaranje menija televizora.

3. DUGME ZA POJAČANJE ZVUKA VOL+

Za pojačanje nivoa jačine zvuka.

4. DUGME ZA SMANJIVANJE ZVUKA VOL-

Za smanjenje nivoa jačine zvuka.

5. DUGME ZA BIRANJE SLEDEĆEG PROGRAMA CH+

Za biranje sledećeg programa.

6. DUGME ZA BIRANJE PRETHODNOG PROGRAMA CH-

Za biranje prethodnog programa.

7. STANDBY DUGME

Uključiti/isključiti televizor dok je u standby režimu rada.

OPIS KOMANDNIH DUGMIĆA I KONEKTORA

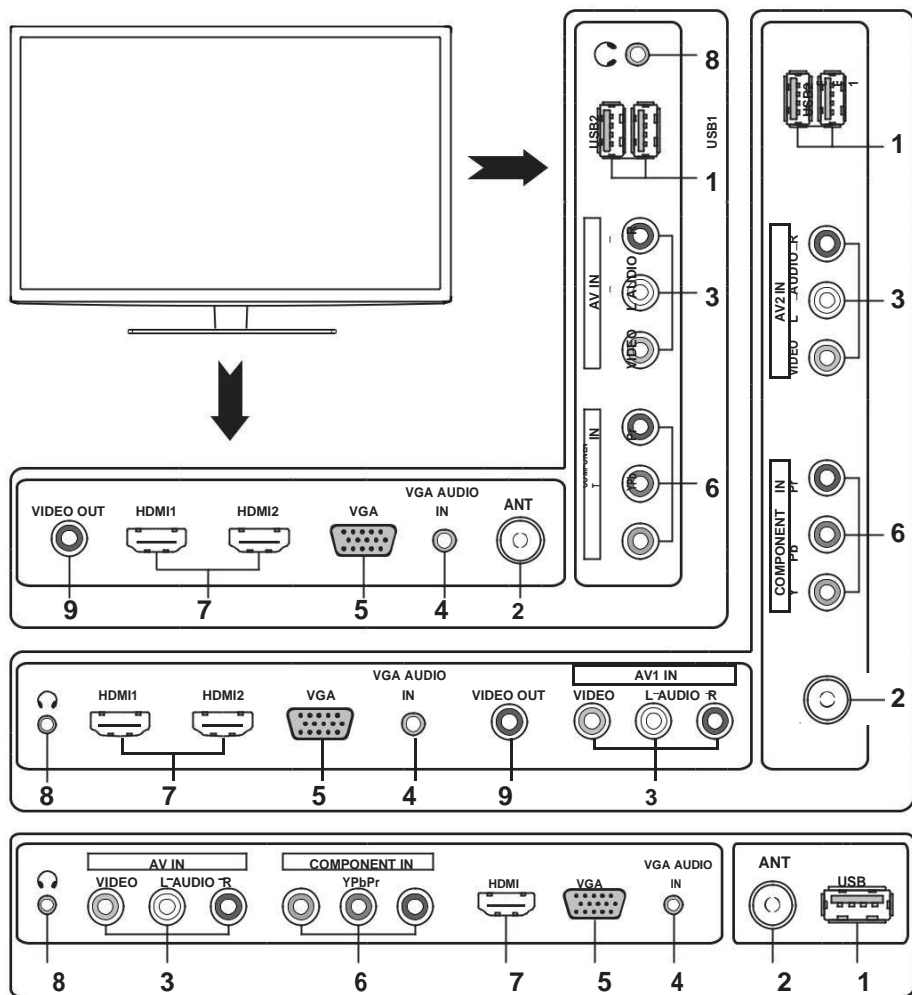

- 1.USB / USB1 / USB2 IN (USB input port)
2. TERMINAL ANTENNA (75 OHM) TV signal ulazni port.
3. AV / AV1 / AV2 IN (AV / AV1 / AV2 ulazni port)
- 4.VGAAUDIOIN (VGA audio ulazni port)
- 5.VGA (RGB signal ulazni port)
- 6.COMPONENT IN (YPbPr signal ulazni port)
- 7.HDMI / HDMI1 / HDMI2 (HDMI signal ulazni port)
- 8.IZLAZ ZA SLUŠALICE (izlazni port za slušalice)
- 9.VIDEOOUT (VIDEO izlazni port)

FUNKCIJE DALJINSKOG UPRAVLJAČA

Daljinski upravljač se ne može koristiti ako nije u dometu prijemnika. Pre upotrebe daljinskog upravljača molimo vas da se uverite da nema prepreka između njega i prijemnika.

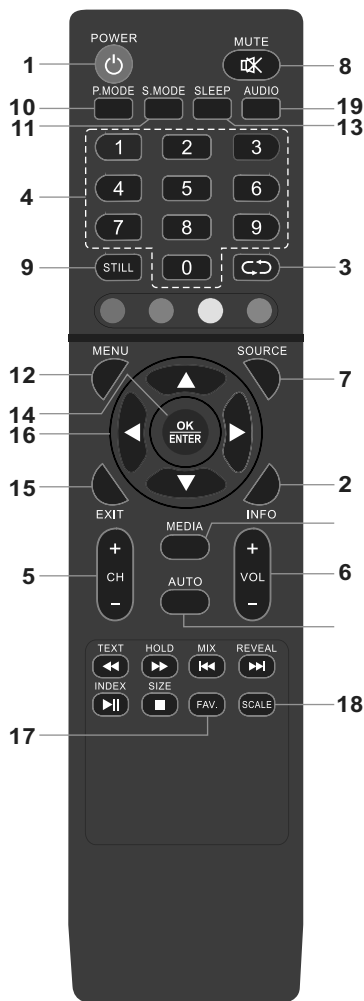

1. POWER DUGME

Uključiti/isključiti televizor dok je u standby režimu rada.

2. INFO DUGME

Prikaz informacija o programu.

3. RETURN DUGME

Prebacivanje sa trenutnog programa na program koji ste prethodno gledali.

4. DUGMIĆI SA BROJEVIMA

Pritisnite ove dugmiće kako bi izabrali željeni program ili uneli lozinku.

5. CH+/CH- DUGME

Biranje sledećeg ili prethodnog programa.

6. VOL+/VOL- DUGME

Pojačavanje ili smanjenje nivoa jačine zvuka.

7. SOURCE DUGME

Izbor izvora ulaznog signala.

8. MUTE DUGME

Isključivanje odnosno ponovno uključivanje zvuka.

9. STILL DUGME

Zamrzavanje slike.

10. P.MODE DUGME

Biranje efekta slike.

11. S.MODE DUGME

Biranje efekta zvuka.

12. MENU DUGME

Otvaranje glavnog menija televizora. Pritisnite ga ponovo ili dugme EXIT kako bi zatvorili meni.

13. SLEEP DUGME

Podešavanje vremena automatskog gašenja televizora.

14. OK/ENTER DUGME

Pritisnite ovo dugme kako bi potvrdili izabranu opciju.

15. EXIT DUGME

Pritisnite ovo dugme za izlazak.

16. DUGMAD SA STRELICAMA

Koristite ovu dugmad kako bi u meniju televizora došli do željene opcije.

17. FAV. DUGME

Prikazuje listu omiljenih programa.

18. SCALE DUGME

Pritisnite dugme kako bi prikazali i odabrali ponuđene veličine slike.

19. AUDIO DUGME (Opciono)

Izbor različitih TV audio sistema ili jezika.

20. MEDIA DUGME

Direktno biranje USB moda.

21. AUTO DUGME

U VGA modu,automatsko podešavanje pozicije slike.

FUNKCIJE DALJINSKOG UPRAVLJAČA

TELETEXT FUNKCIJA (Opciono)

1) TEXT DUGME

Pritisnite TEXT dugme kako bi se sa TV-a prebacili na teletekst ako postoji na izabranom programu.

2) REVEAL DUGME

Prikazuje skriveni tekst.

3) MIX DUGME

Koristite ovo dugme kako bi prikazali sliku televizora i teletekst zajedno ili samo teletekst.

4) CRVENO/ZELENO/ŽUTO/PLAVO DUGME

Ova 4 dugmića u boji, dok ste u teletekstu, vas prebacuju na već predodređene stranice.

5) ▲ / ▼ DUGME

U teletekstu ovu dugmići vam pomeraju stranicu koju gledate gore/dole.

6) 0, 1, 2, ..., 9 DUGME

U teletekstu ovi dugmići vam pomažu da odaberete željenu stranu.

7) HOLD DUGME

Određene teletekst informacije se nalaze na više od jedne strane, koje se menjaju u određenom vremenskom intervalu. Pritisnite ovo dugme kako bi zaustavili menjanje strana. Ponovo ga pritisnite za nastavak.

8) INDEX DUGME

Pritisnite ovo dugme kako bi videli indeks stranicu teleteksta.

9) SIZE DUGME

Ovo dugme povećava veličinu slova u teletekstu. Svako pritisnjanje ovog dugmeta menja veličinu slova dok se na kraju ne vrati na normalnu veličinu.

USB FUNKCIJA (Opciono)

1) ◀ / ▶ DUGME

Preskakanje scene ili muzike.

2) ◀◀ / ▶▶ DUGME

Prethodni/sledeći.

3) ▶|| DUGME

Play / Pauza.

4) ■ DUGME

Stop dugme.

Obratite pažnju:

USB uređaj mora biti priključen.

POSTAVLJANJE BATERIJA DALJINSKOG UPRAVLJAČA

1. Otvorite poklopac daljinskog upravljača.

2. Ubacite dve AAA baterije od 1.5V. Uverite se da polaritet baterija (+ i -) odgovaraju oznakama na daljinskom upravljaču.

3. Zatvorite poklopac.

Note:

- Preporučujemo da koristite alkalne baterije.
- Baterije mogu trajati i do godinu dana u zavisnosti od toga koliko često koristite daljinski upravljač. Za najbolji učinak baterije menjajte godišnje ili ako primetite nepravilnosti u radu daljinskog upravljača.
- Budite sigurni da ste baterije postavili kako je prikazano na slici.
- Ne mešajte stare i nove baterije ili baterije različitih vrsta.
- Stare baterije mogu da procure i oštete daljinski upravljač. Promenite baterije čim primetite da su oslabile.

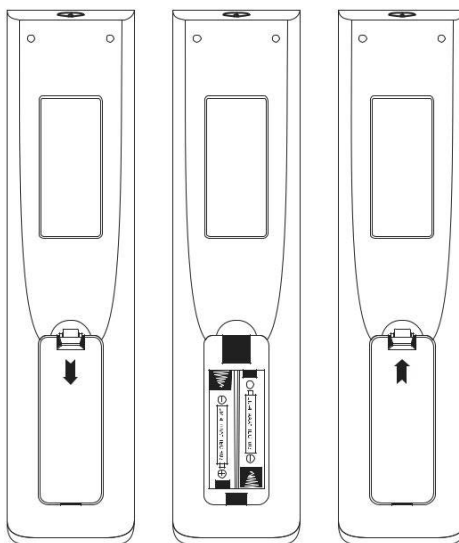

KONEKCIJE

INSTALACIJA ANTENE

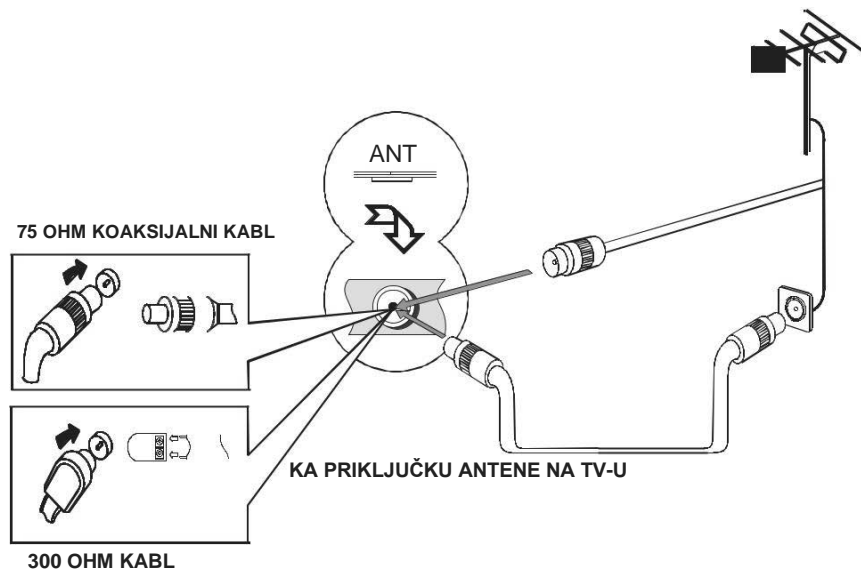

Povežite 75 OHM koaksijalni kabl od antene do antenskog priključka na zadnjem delu televizora kao što je prikazano na slici.

Obaveštenje:

- Za bolji prijem, naročito u ruralnim oblastima, gde ima puno smetnji, preporučljivo je korišćenje spoljne antene na krovu.
- Za UHF TV prijem, koristite posebnu UHF antenu. Konsultujte se sa lokalnim prodavačem.
- Pri korišćenju 300 OHM kabla, koristite 300 OHM - 75 OHM adapter za pravilnu konekciju sa antenskim priključkom televizora.

PRIKLJUČAK ZA NAPAJANJE

- Priključite kabl za napajanje uređaja u odgovarajuću utičnicu.
- Pritisnite dugme POWER na daljinskom upravljaču da uključite/isključite TV.

Obaveštenje:

- Ovaj uređaj radi sa neizmeničnim napajanjem od 100-240V~ 50/60Hz.
- Kada isključujete kabl za napajanja uradite to pomoću utikača, a ne samog kabla.

UPOZORENJE:

Prilikom nestanka struje isključite uređaj iz napajanja. Kako bi uštedeli struju isključite TV iz napajanja ako ga ne koristite duži vremenski period.

AUTOMATSKO PODEŠAVANJE KANALA

1. Povežite kabl kablovske televizije ili antenski kabl sa antenskim priključkom televizora.
2. U TV režimu rada, pritisnite Menu dugme na samom TV-u ili daljinskom upravljaču.
3. Pritisnite dugme strelica levo/desno na daljinskom upravljaču kako bi izabrali opciju Channel, zatim pritisnite dugme strelica gore/dole i izaberite opciju Auto Tuning.
4. Pritisnite dugme OK ili strelicu desno kako bi započeli automatsku pretragu svih raspoloživih programa. Prilikom automatske pretrage pritisnite dugme 'MENU' kako bi se prikazala opcija 'Do you want to exit tuning? ◀ Yes No ▶', Pritiskom na strelicu levo prekidate automatsku pretragu kanala.

Obaveštenje:

- Molimo vas da budete strpljivi, jer pretraga traje nekoliko minuta.

Sada ste spremni da gledate TV program

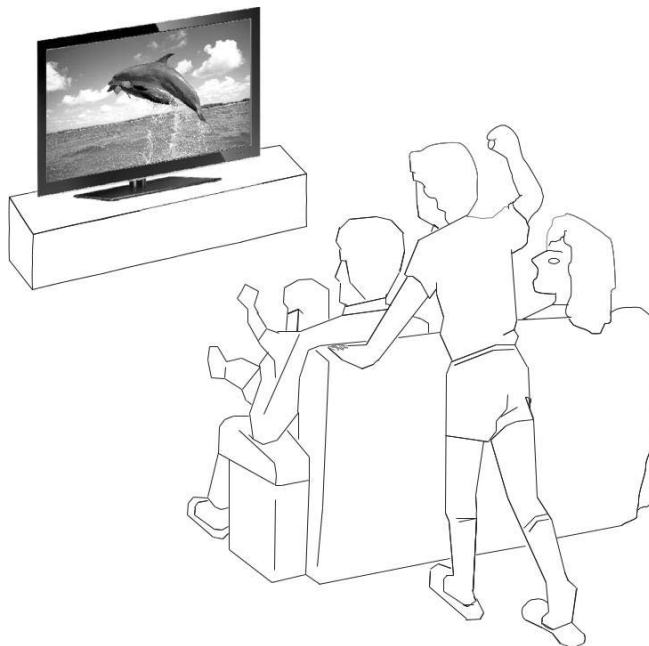

FUNKCIJE MENIJA

MAIN MENI FUNKCIJE

Pritisnite dugme MENU kako bi prikazali opcije glavnog menija. Kako je prikazano niže :

Obaveštenje:

Ako je opcija prikazana u sivoj boji to znači da ona nije dostupna ili da se ne može menjati sa trenutnim podešavanjima uređaja.



PICTURE MENI FUNKCIJE

Pritisnite dugme strelica levo/desno kako bi izabrali Picture meni. Kako je prikazano niže:

1. Podešavanja slike

Pritisnite strelicu gore/dole u Picture Mode, opcijama, a zatim OK dugme kako bi izabrali Picture Mode podmeni, zatim strelice gore/dole kako bi izabrali Standard, Mild, User ili Dynamic opciju. Pritisnite OK dugme da potvrdite izbor. Pritisnite dugme Menu za povratak.

2. Kontrast/Osvetljenost/Boja/Senka/Oštrina podešavanja

Pritisnite strelice gore/dole kako bi izabrali Contrast, Brightness, Color, Tint ili Sharpness opciju, zatim strelicu levo/desno kako bi smanjili/povećali vrednost opcija Contrast, Brightness, Color, Tint ili Sharpness. Pritisnite dugme MENU za povratak.

3. Podešavanje inteziteta boja

Pritisnite strelice gore/dole kako bi izabrali Color Temperature opciju, a zatim dugme OK kako bi izabrali Color Temperature podmeni, zatim strelicu levo/desno i izaberite opciju Cool, Medium ili Warm, na kraju pritisnite OK dugme za potvrdu izbora. Pritisnite dugme MENU za povratak.

4. Smanjivanje šuma slike

Pritisnite strelice gore/dole kako bi izabrali Noise Reduction opciju, zatim OK dugme kako bi izabrali Noise Reduction podmeni, zatim strelicu levo/desno kako bi izabrali Off, Low, Middle ili High, na kraju pritisnite OK dugme za potvrdu izbora. Pritisnite dugme MENU za povratak.

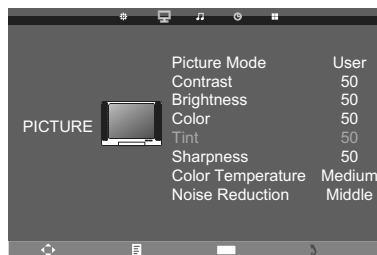

SOUND MENI FUNKCIJE

Pritisnite dugme strelica levo/desno kako bi izabrali Sound meni. Kako je prikazano desno:

1. Podešavanje zvuka

Pritisnite strelicu gore/dole i izaberite Sound Mode opciju, zatim dugme OK kako bi izabrali Sound Mode podmeni, zatim strelicu levo/desno i izaberite opciju Standard, Music, Movie, Sports ili User, na kraju pritisnite OK dugme za potvrdu izbora. Pritisnite dugme MENU za povratak.

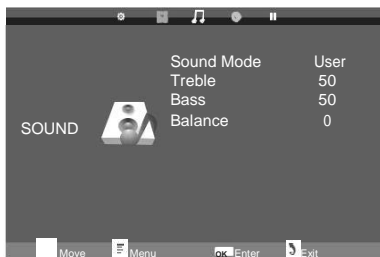

FUNKCIJE MENIJA

2. Treble/Bass podešavanja

Pritisnite strelicu gore/dole i izaberite Treble ili Bass opciju, zatim strelicu levo/desno i ikako bi pojačali/smanjili Treble ili Bass. Pritisnite dugme MENU za povratak.

3. Podešavanje balansa

Pritisnite strelicu gore/dole i izaberite Balance opciju, zatim strelicu levo/desno i ikako bi podesili jačinu levog/desnog zvučnika. Pritisnite dugme MENU za povratak.

PODEŠAVANJE VREMENA

Pritisnite strelicu levo/desno i izaberite Time opciju. Kao što je prikazano dole:

1. Podešavanje sata

Pritisnite strelicu gore/dole i izaberite Clock opciju, zatim dugme OK kako bi izabrali Clock podmeni.

Pritisnite gore/dole kako bi izabrali željenu opciju, zatim dugme levo/desno kako bi je podesili.

Pritisnite dugme MENU za povratak.

2. Podešavanje vremena gašenja TV-a

Pritisnite strelicu gore/dole i izaberite Off Time opciju, zatim dugme OK kako bi izabrali Off Time podmeni.

Zatim strelicu gore/dole kako bi izabrali željenu opciju i strelicu levo/desno kako bi je podesili

Pritisnite dugme MENU za povratak.

3. Podešavanje vremena paljenja TV-a

Pritisnite strelicu gore/dole i izaberite Time opciju, zatim dugme OK kako bi izabrali On Time podmeni. Pritisnite strelicu gore/dole kako bi izabrali željenu opciju, zatim strelicu levo/desno kako bi je podesili. Pritisnite dugme MENU za povratak.

4. Podešavanje vremena gašenja TV-a (u minutima)

Pritisnite strelicu gore/dole i izaberite Sleep Timer opciju, zatim dugme OK kako bi izabrali Sleep Timer podmeni. Pritisnite strelicu gore/dole i izaberite vrednost: Off, 10min, 20min, 30min, 60min, 90min, 120min, 180min ili 240min, na kraju pritisnite OK dugme da potvrdite izbor. Pritisnite dugme MENU za povratak.

5. Podešavanje vremena prikaza menija

Pritisnite strelicu gore/dole i izaberite OSD Timer opciju, zatim pritisnite OK dugme kako bi izabrali OSD Timer podmeni. Pritisnite strelicu gore/dole i izaberite vrednost: 5 S, 10 S, 15 S, 20 S, 25 S ili 30 S, na kraju pritisnite OK dugme da potvrdite izbor. Pritisnite dugme MENU za povratak.



Funkcije menija OPTION

Pritisnite strelicu levo/desno i izaberite Option opciju. Kao što je prikazano dole:

1. Podešavanje jezika menija

Pritisnite strelicu gore/ dole i izaberite OSD Language opciju, zatim dugme OK kao bi izabrali OSD Language podmeni. Pritisnite strelicu levo/desno kako bi izabrali željeni jezik, na kraju pritisnite dugme OK da potvrdite izbor. Pritisnite dugme MENU za povratak.

2. Podešavanje jezika teleteksta (Opciono)

Pritisnite strelicu gore/ dole i izaberite TTX Language opciju, zatim dugme OK kao bi izabrali TTX Language podmeni. Pritisnite strelicu gore/dole

i izaberite opciju: West, East, Russian, Arabic ili Farsi, pritisnite dugme OK da potvrdite izbor. Pritisnite dugme MENU za povratak.

3. Podešavanje veličine slike

Pritisnite strelicu gore/ dole i izaberite Scale opciju, zatim pritisnite OK dugme kako bi izabrali Scale podmeni. Pritisnite strelicu gore/dole kako bi izabrali željenu vrednost. Pritisnite dugme MENU za povratak.

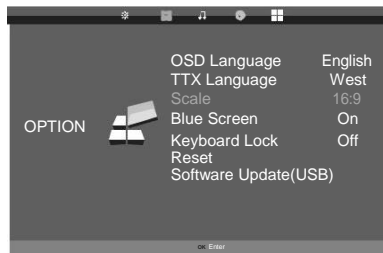

FUNKCIJE MENIJA

4. Plavi ekran/zaključavanje tastature

Pritisnite strelicu gore/ dole i izaberite Blue Screen ili Keyboard Lock opciju, pritisnite zatim strelicu levo/ desno kako bi uključili/isključili ovu opciju. Pritisnite dugme MENU za povratak.

5. Resetovanje

Pritisnite strelicu gore/ dole i izaberite Reset opciju, zatim pritisnite OK kako bi prikazali 'Are you sure ? ◀ Yes No ▶', Pritisnite strelicu levo za DA odnosno strelicu desno za NE. Pritisnite dugme MENU za povratak.

6. Software Update(USB)

Pritisnite strelicu gore/ dole i izaberite Software Update (USB) opciju, pritisnite dugme OK da potvrdite izbor.

Obaveštenje: Koristiti samo po savetu korisničkog servisa.

FUNKCIJE MENIJA U TV MODU

FUNKCIJE CHANNEL MENIJA

Pritisnite strelicu levo/desno i izaberite Channel opciju. Kao što je prikazano dole:

1. Automatsko podešavanje kanala

Pritisnite strelicu gore/ dole i izaberite Auto Tuning opciju, zatim OK dugme kako bi otpočeli pretragu. TV će pronaći sve raspoložive kanale. Tokom automatske pretrage pritisnite MENU kako bi prikazali: 'Do you want to exit tuning? ◀ Yes No ▶', zatim pritisnite strelicu levo kako bi zaustavili pretragu.

2. Ručno podešavanje kanala

Pritisnite strelicu gore/ dole i izaberite Manual Tuning opciju, zatim pritisnite OK dugme kako bi izabrali Manual

Tuning podmeni. Pritisnite strelicu gore/dole i izaberite Current CH, Color System, Sound System, Fine-Tune ili AFC opciju, zatim pritisnite strelicu levo/desno kako bi je podesili. Pritisnite strelicu gore/dole i izaberite Search opciju, zatim pritisnite strelicu levo za pretraživanje kroz kanale od viših do nižih. Pritisnite strelicu desno za pretraživanje kroz kanale od nižih do viših. Zaustavite pretragu kad nađete željene kanale. Pritisnite dugme MENU za povratak.

3. Uređivanje programa

Pritisnite strelicu gore/ dole i izaberite Programme Edit opciju, zatim pritisnite OK dugme kako bi izabrali Programme Edit podmeni, Pritisnite strelicu gore/dole i izaberite željenu kanal, zatim pritisnite CRVENO dugme za brisanje kanala. Pritisnite ZELENO dugme kako bi preimenovali kanal. Pritisnite ŽUTO dugme da premestite kanal. Pritisnite PLAVO dugme da preskočite kanal. Pritisnite FAV dugme da ga označite kao omiljeni kanal. Pritisnite dugme MENU za povratak.



FUNKCIJE MENIJA U VGA MODU

FUNKCIJE VGA MENIJA

Pritisnite strelicu levo/desno i izaberite Screen opciju. Kao što je prikazano desno:

1. Automatsko podešavanje

Pritisnite strelicu gore/dole i izaberite Auto Adjust opciju, zatim pritisnite dugme OK kako bi potvrdili izbor.

2. Horizontal Pos./Vertical Pos./Clock/Phase podešavanja

Pritisnite strelicu gore/dole i izaberite Horizontal Pos., Vertical Pos., Clock ili Phase opciju. Pritisnite strelicu levo/desno kako bi podesili željenu opciju. Pritisnite dugme MENU za povratak.

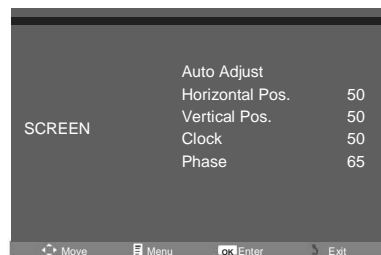

FUNKCIJE MENIJA

FUNKCIJE USB MENIJA

Pritisnite dugme Source kako bi prikazali Source meni, a zatim strelicu gore/dole i izaberite Media (Media1 ili Media2) opciju, zatim pritisnite dugme OK kako bi otvorili prikaz kao što je prikazano desno:

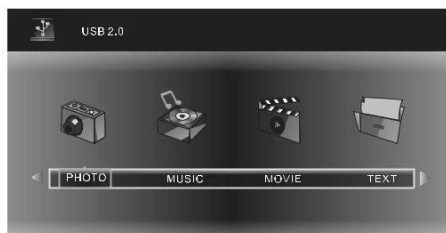

Pritisnite strelicu levo/desno i izaberite PHOTO, MUSIC, MOVIE ili TEXT opciju, zatim pritisnite dugme OK kako bi potvrdili izbor i otvorili novi meni kao što je prikazano desno:

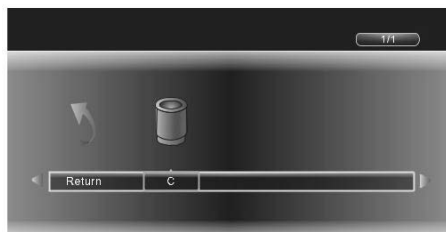

1. Photo

- 1) Pritisnite strelicu levo/desno i izaberite 'PHOTO' opciju.
- 2) Pritisnite dugme OK kako bi izabrali meni za odabir diskova.
- 3) Pritisnite strelicu levo/desno kako bi izabrali željeni disk i otvorili podmeni. Pritisnite dugme ↶ kako bi se vratili na prethodni meni.
- 4) Pritisnite strelicu gore/dole/levo/desno kako bi odabrali fajlove. Pritisnite dugme OK kako bi označili željene fajlove (označene sa znakom štikliranja) za selektivnu reprodukciju. Pritiskom na CRVENO dugme, odabracete podmeni u kojem možete brisati fajlove.
- 5) Pritisnite strelice levo/desno/gore/dole kako bi videli prikaz fajla, kao što je prikazano dole:
- 6) Pritisnite dugme Play kako bi videli izabrane slike u vidu slajdova (prikazuje štiklirane slike; ako nijedan fajl nije štikliran prikazaće sve slike), Pritisnite dugme OK kako bi prikazali meni.

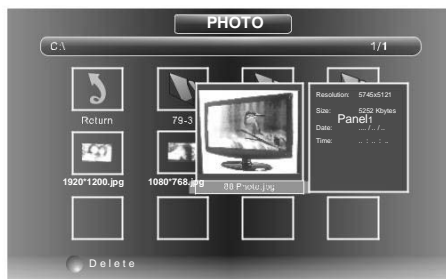

Prema prikazanom meniju, pritisnite strelice levo/desno kako bi izabrali ponuđene opcije, zatim pritisnite dugme OK kako bi potvrdili izbor. Pritisnite dugme EXIT za izlazak.



FUNKCIJE MENIJA

2. Music

- 1) Pritisnite strelicu levo/desno i izaberite 'MUSIC' opciju.
- 2) Pritisnite dugme OK kako bi prikazali Music opciju, zatim strelicu gore/dole/levo/desno kako bi prikazali informacije o muzičkom fajlu. Kao što je prikazano desno:
- 3) Pritisnite dugme Play kako bi slušali izabranu muziku. Kao što je prikazano desno:

Pause

Pritisnite dugme Pause za pauzu.

Play

Pritisnite dugme Play kako bi slušali muziku.

FB

Pritisnite dugme FB kako bi usporili muziku 2X, 4X, 8X ili 16X.

FF

Pritisnite dugme FF kako bi ubrzali muziku 2X, 4X, 8X ili 16X.

PREV.

Pritisnite dugme Prev. za prethodnu pesmu.





NEXT

Pritisnite dugme Next za sledeću pesmu.

Stop

Pritisnite dugme Stop kako bi zaustavili muziku.

Repeat All

Pritisnite dugme  kako bi ponovili pesmu ( Repeat 1,  Repeat All,  Repeat None).

Mute

Pritisnite dugme  kako bi isključili zvuk.

Playlist

Pritisnite dugme Playlist kako bi prikazali listu pesama.

Info.

Pritisnite dugme Info. kako bi prikazali informacije o pesmi.

Goto Time

Pritisnite dugme Goto Time kako bi označili određeno vreme pesme.

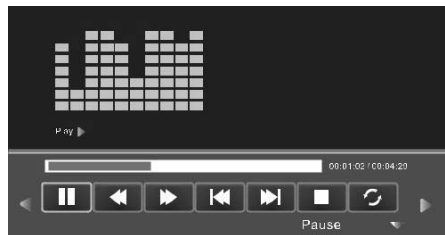
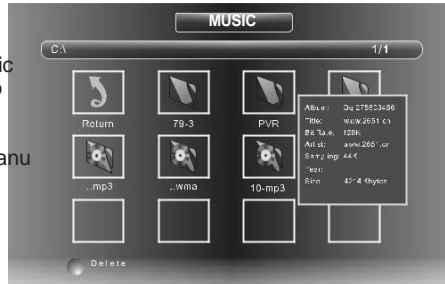

3. Movie

- 1) Pritisnite dugme levo/desno i izaberite 'MOVIE' opciju.
- 2) Pritisnite dugme OK kako bi prikazali Movie opciju, zatim strelicu gore/dole/ levo/desno kako bi videli prikaz fajla. Kao što je prikazano desno:
- 3) Pritisnite dugme Play kako bi izabrali film. Pritisnite dugme OK kako bi prikazali meni. Pritisnite dugme Play ponovo kako bi prikazali film preko celog ekrana. Pritisnite dugme Pause kako bi pauzirali film. Pritisnite dugme Prev. ili Next za prethodni/naredni film. Pritisnite dugme FB ili FF za usporenje/ ubrzanje reprodukcije filma. Pritisnite dugme Stop ili za povratak.



FUNKCIJE MENIJA

4. Text

- 1) Pritisnite strelicu levo/desno i izaberite 'TEXT' opciju.
- 2) Pritisnite dugme OK kako bi prikazali Text meni, zatim strelicu gore/ dole/ levo/desno kako bi videli prikaz fajla. Kao što je prikazano desno:
- 3) Pritisnite dugme Play da prikazete izabrani fajl, a dugme OK da prikazete meni. Kao što je prikazano desno:

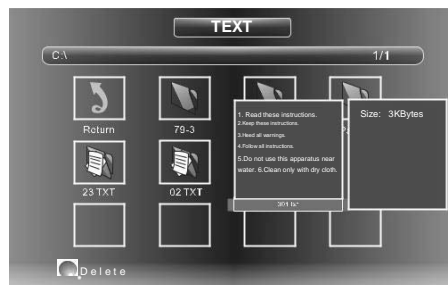

Prema prikazanom meniju pritisnite strelice levo/desno kako bi izabrali ponuđene opcije, zatim pritisnite dugme OK kako bi potvrdili izbor. Pritisnite dugme EXIT za izlazak.

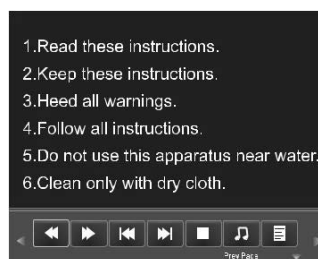

VODIČ ZA REŠAVANJE PROBLEMA

Većina kvarova su izazvani zbog manjih pogrešnih podešavanja vašeg televizora ili sličnih jednako jednostavnih razloga. Ako se javi bilo kakav problem u normalnom radu vašeg televizora proverite tabelu uobičajenih problema koja je prikazana dole.

Ako se problem i dalje javlja, isključite vaš televizor iz napajanja i pozovite prodavca.

SIMPTOM	METODE PROVERE I PODEŠAVANJA
Nema slike ili zvuka	Proverite da li je TV povezan sa napajanjem. Proverite kućne osigurače.
Ima slike, ali ne i zvuka	Proverite da li je zvuk ugašen ili na minimumu.
Daljinski upravljač ne radi	Proverite da li je TV upaljen. Proverite da li su baterije pravilno postavljene. Proverite da li je infracrveni senzor na TV-u izložen jakom svetlu ili da li ima prepreka ispred njega.
Nema TV signala	Proverite da li je SOURCE prekidač podešen na opciju TV. Proverite vezu sa antenom. Proverite metodu pretrage kanala.
Nema signala iz spoljnog izvora	Proverite da li je SOURCE dugme u pravilnom položaju za prijem.
Problemi sa kontrastom i osvetljenjem na svim kanalima	Izvršite potrebna podešavanja bitnih opcija.
Loš kontrast i loša boja na svim kanalima	Proverite poziciju antene.
Tačkaste linije i pruge se pojavljuju na ekranu	Postoji mogućnost da drugi električni uređaj pravi smetnje. Ako se problem i dalje javlja premestite uređaj.
“Sneg” na ekranu	Proverite da li je antena ili da li su njene veze sa TV-om oštećene.
Dupla slika	Proverite položaj i lokaciju antene - jaki vetrovi mogu da je pomere. Proverite da li planine i visoke zgrade predstavljaju problem. Manja podešavanja pravca u kojem je antena usmerena mogu svesti problem na minimum.

Obaveštenje: Podešavanje krovne antene treba da prepustite kvalifikovanoj osobi.

SPECIFIKACIJE

Veličina slike	16 : 9
Sistem	PAL/SECAM BG, DK, I NTSC Playback
Impendansa	75 Ω (Unbalance)
Vrste TV kanala	Prima sve kanale
Napajanje	100-240V~ 50/60Hz

Obaveštenje: Dizajn i specifikacije se mogu promeniti bez prethodne najave.

INFRACRVENI DALJINSKI UPRAVLJAČ

Karakteristike: U potpunosti funkcionalan Daljinski upravljač.

Efektivna udaljenost: 8 metara

Napajanje: DC 3V (Dve baterije, veličine AAA, preporučujemo alkalne baterije)

Medija

Kada izaberete opciju Media kao izvor ulaznih signala (SOURCE) i priključite USB, možete pogledati fajlove na njemu.

Postoje 4 vrste medija i to: Fotografije (PHOTO), muzika (MUSIC), film (MOVIE), tekst (TEXT).

Podržani fajlovi:

Tip fajla	Podržani formati fajlova	Ekstenzija fajla
Foto	BMP / JPEG	.bmp / .jpeg
Audio	MP3	.mp3
Video	MPEG1 /MPEG2	.mpg / .dat / .vob / .avi
Text	TXT	.txt

Obaveštenje:

Nije kompatibilan sa HDD-om. Fajl koji puštate mora imati licencu (kupac bi trebao da proveri postojanje iste) ili neće biti reprodukovano.