



# UPUTSTVO ZA UPOTREBU

## LED TELEVIZORI

Model:43DLE788

Hvala Vam što ste kupili ovaj uređaj.

FOX LED televizori prepoznaju se po odličnim tehničkim karakteristikama, kao i modernom, funkcionalnom i elegantnom dizajnu. Osim toga konstantna unapređenja u vidu postprodajne podrške, izuzetno efikasna i rasprostranjena servisna mreža čine da se ponosni vlasnici FOX televizora mogu osećati sigurno.

Napravili ste pravi izbor.

U nastavku slede uputstva za upotrebu. Nisu komplikovana, ali ih se morate pridržavati.



Android™ OS



# CONTENTS

<b>Safety Information</b> .....	3
<b>Important Safety Precautions</b> .....	4
<b>TV Buttons And Terminal Interface</b> .....	5
<b>External device connection diagram</b> .....	6
<b>Install And Connect TV</b> .....	7
<b>OSD</b> .....	8
<b>Help</b> .....	24
<b>Specifications</b> .....	25
<b>Romote Controller</b> .....	26
<b>Enviromental Protection</b> .....	27

# SAFETY INFORMATION

## CAUTION

**RISK OF ELECTRIC SHOCK  
DO NOT OPEN**

High voltages are used in the operation of this product. to reduce the risk of electric shock, do not remove cover of the cabinet, refer servicing to qualified service personal

If the TV any changes or coarse adjustment, electric shocks to be hurt, do not attempt to open a machine-maintenance, customer contact centres needed overhaul.



The exclamation point within an equilateral triangle is intended to alert the user to the presence of important operating in the literature accompanying the appliance.

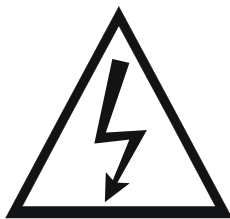

**Warning**  
The lightning flash with arrowhead symbol within an equilateral triangle, is intended to alert the user to the presence of uninsulated dangerous voltage within the products enclosure that may be of sufficient magnitude to constitute a risk of electric shock to persons.

# IMPORTANT SAFETY PRECAUTIONS

- 1) Read these instructions.
- 2) Keep these instructions.
- 3) Heed all warnings.
- 4) Follow all instructions.
- 5) Do not use this apparatus near water.
- 6) Clean only with dry cloth.
- 7) Do not block any ventilation openings. Install in accordance with the manufacturer's instructions.
- 8) Do not install near any heat sources such as radiators, heat registers, stoves, or other apparatus (including amplifiers) that produce heat.
- 9) Do not defeat the safety purpose of the polarized or grounding-type plug. A polarized plug has two blades with one wider than the other. A grounding type plug has two blades and a third grounding prong. The wide blade or the third prong are provided for your safety, If the provided plug does not fit into your outlet, consult an electrician for replacement of the obsolete outlet.
- 10) Protect the power cord from being walked on or pinched particularly at Plugs, convenience receptacles, and the point where they exit from the apparatus.
- 11) Only use attachments /accessories specified by the manufacturer.
- 12) Use only with the cart, stand, tripod, bracket, or table specified by the manufacturer, or sold with the apparatus. When a cart is used caution when moving the cart/apparatus combination to avoid injury tip-over.



- 13) Unplug this apparatus during lightning storms or when unused for long periods of time.

#### Caution:

- 14) To reduce the risk of fire or electric shock, do not expose this apparatus to rain or moisture.
- 15) The mains plug is used as disconnect device, the disconnect device shall remain readily operable.
- 16) The socket-out shall be installed near the equipment and shall be easily accessible.
- 17) This product should never be placed in a built-in installation such as a bookcase or rack unless proper ventilation is provided or the manufacture's instructions have been adhered to.
- 18) The apparatus shall not be exposed to dripping or splashing and that no objects filled with liquid, such as vases, shall be placed on the apparatus.
- 19) Do not place any sources of danger on the apparatus (e.g. liquid filled objects, lighted candles).
- 20) Wall or Ceiling Mounting - The appliance should be mounted to a wall or ceiling only as recommended by the manufacturer.
- 21)  Never place the TV, remote control or batteries near naked flames or other heat sources, including direct sunlight. To prevent the spread of fire, keep candles or other flames away from the TV, remote control and batteries at all times.
- 22) The USB terminal should be loaded with 0.5 A under normal operation.

These servicing instructions are for use by qualified service personnel only. To reduce the risk of electric shock do not perform any servicing other than that contained in the operating instructions unless you are qualified to do so.

- 23) The battery shall not be exposed to excessive heat such as sunshine, fire or the like.
- 24)  This equipment is a Class II or double insulated electrical appliance. It has been designed in such a way that it does not require a safety connection to electrical earth
- 25) The maximum using environment temperature is 45 degrees.  
The Maximum using altitude is 2000 meters

# TV BUTTONS AND TERMINAL INTERFACE

## TV Buttons

Note: The key instructions are subject to below.

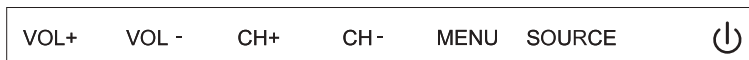

**Display\ Hide key icon:** When there is no button icon popping up, press the key, the key icon will pop up like the picture shows above, the key icon will automatically turn off after 5 seconds of inactivity.

**Icon selection:** Short press the button, move the loop to the right, select the icon.

**Icon function selection:** Long press the key to achieve the function of the selected icon.

**Icon Description:**

**Power off Icon:** Corresponding to the "POWER" button of remote .

**Menu Icon:** Corresponding to the "MENU" button of remote.

**Source Icon:** Corresponding to the "SOURCE" button of remote.

**CH+ Icon:** Corresponding to the "CH+" button of remote.









**CH- Icon:** Corresponding to the "CH-" button of remote.

**Volume+ Icon:** Corresponding to the "VOL+" button of remote.

**Volume- Icon:** Corresponding to the "VOL-" button of remote.

## Terminal Interface

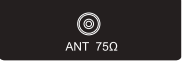
Note: The following are the various terminal interface, the actual position and arrangement, the number of different models may be different.

	<b>AV input</b> External AV Signal Input and Relevant Right/Left Sound Channel		<b>PC AUDIO INPUT</b> VGA input and audio input when VGA input
	<b>RJ45</b> Connect the Internet.		<b>EARPHONE output</b> When earphones are plugged in, speakers are disabled
	<b>HDMI input</b> Digital signal input from HDMI video connector.		<b>USB input</b> Connect a USB device here to play its media files or to record programs via the PVR function.
	<b>ANT75</b> Connect the antenna/cable tv input (75NHF/UHF)		<b>OPTICAL</b> Connect the SPDIF Receiver.
	<b>VGA input</b> PC analog signal input		

# EXTERNAL DEVICE CONNECTION DIAGRAM

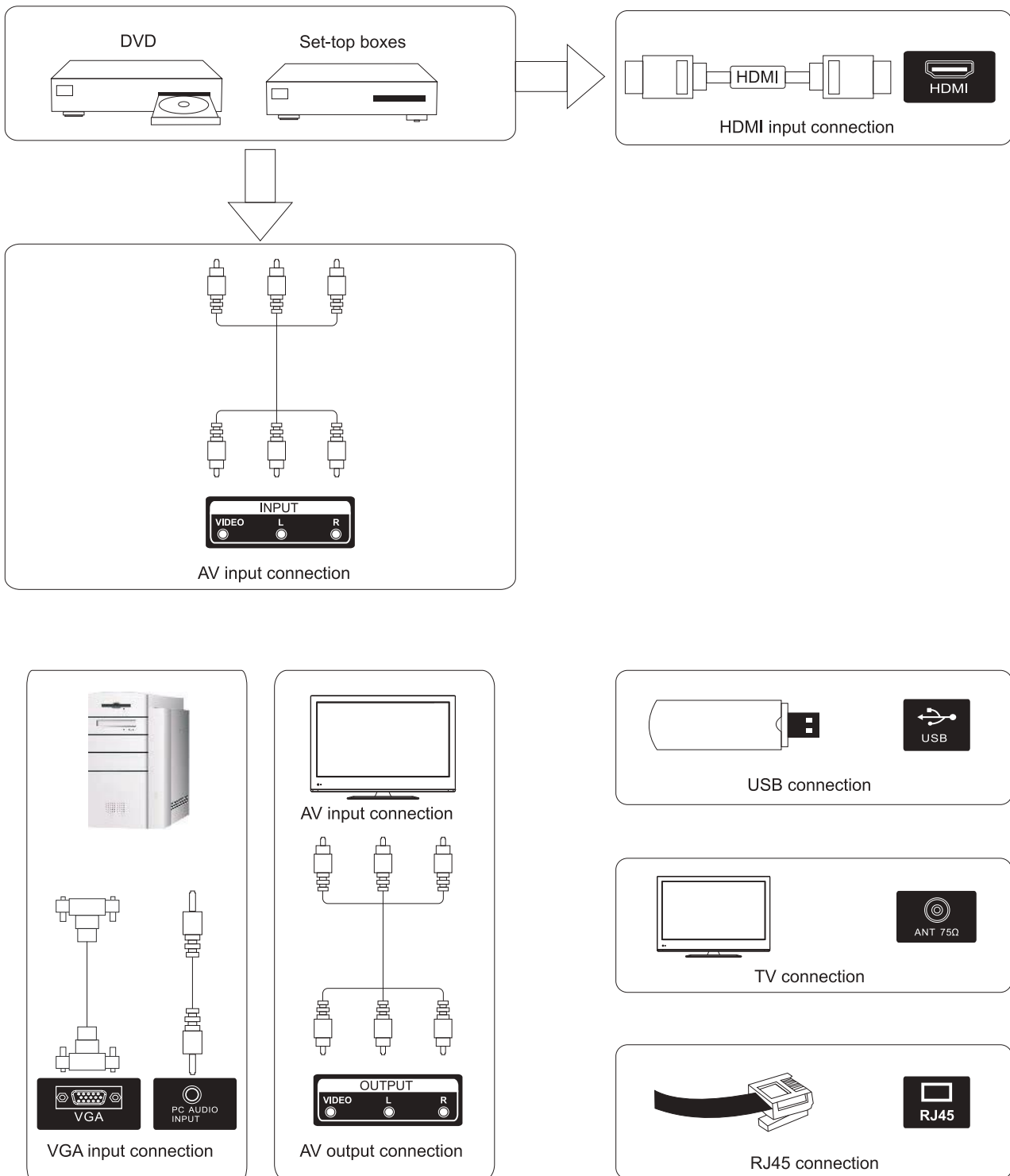

**NOTE**

IF YOUR PROGRAM ON TV WILL BE INCLUDED BY CABLE TELEVISIONS, PLEASE CHECK YOUR EARNING AND POTENTIAL EVALUATION ON THE CABLE OF YOUR CABLE OPERATOR. FOR THESE INFORMATION CONTACT YOUR CABLE OPERATOR.

# INSTALL AND CONNECT TV

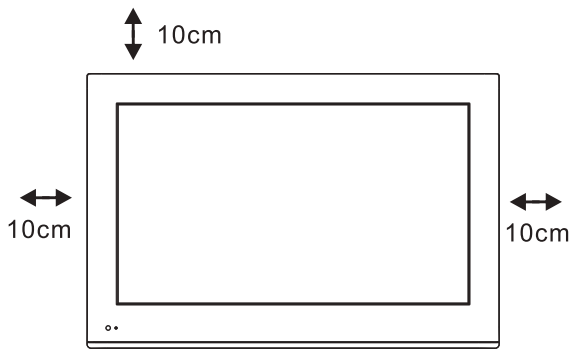

## Set your TV

To put your TV in a firm place which can bear the weight of the TV.

To avoid danger, please don't expose the TV near water or heating place (such as light, candle, heating machine), do not block the ventilation at the back of TV.

## Connect antenna and power

1. Connect the antenna cable to the antenna socket on the back of the TV.
2. To plug the power cord of TV (AC 100-240V~ 50/60Hz).

## Turn on TV

3. Press the power button of the TV the indication light will turn to green. if it is on standby mode (the light is red), press the power button on the remote control to turn on the TV.

### Note:

Picture for reference purposes only.

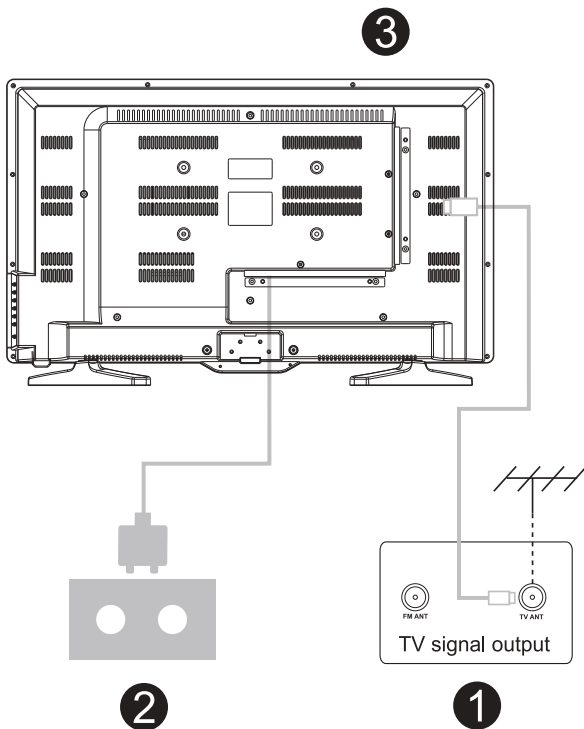

# TV STAND INSTALLATION

1. Open the carton and remove the TV and scattered accessories and base (some models without base).

2. To avoid the injury of the TV, covered with a soft mattress, put it on the table, face down on a soft mattress, the base of the neck is fixed on the TV with screws.

3. Screw the base and connected to the TV.

4. The installation is complete.

### Note:

Picture for reference purposes only.

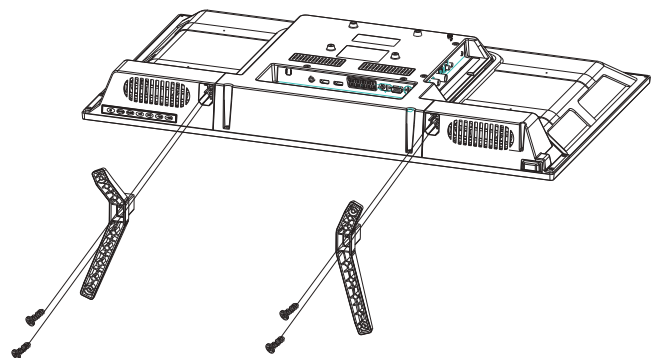

# OSD

## 1.SOURCE



According to the "source" button to display the input source menu, select the corresponding input signal source by the next button, press the confirm button you can enter the relevant signal source.

## 2.TV MENU

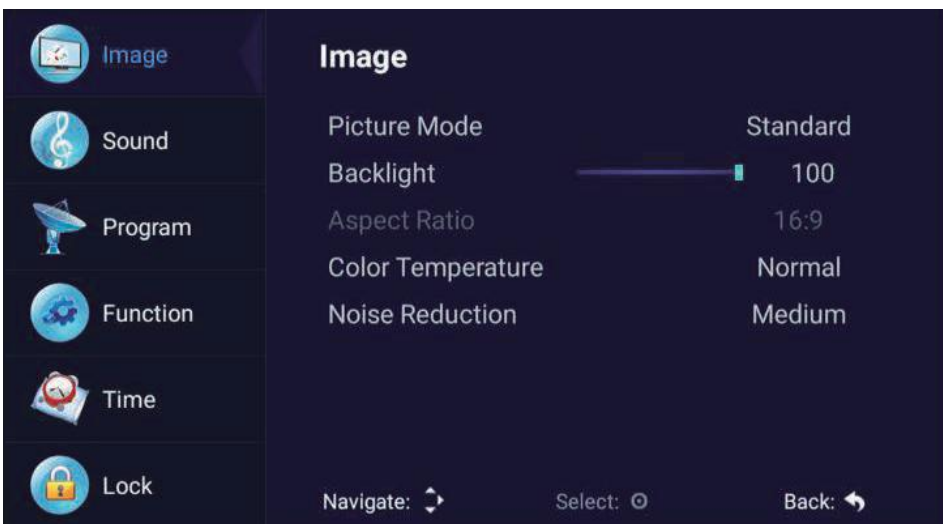

Press the "menu" button to display the menu, press the up and down keys to select the appropriate settings, press the right button to enter the relevant settings , eg: Picture, Sound, Program, Function, Time setting, Lock.



## Picture

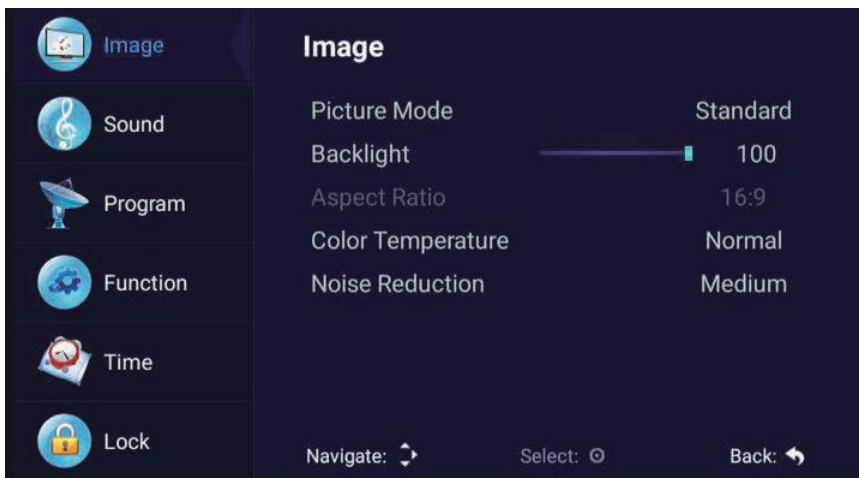

### Picture Mode

Choose the picture menu with left and right keys, and press OK button for next operation. Then the up and down arrows can be used to select this item. The picture mode can be switched to standard/soft/lightness/user.

### Backlight

Adjust the backlight brightness value to change the backlight brightness.

### Aspect Ratio

You can select ZOOM1, ZOOM2, 16:9 or 4:3 with left and right keys when the option of Aspect Ratio is picked.. The aspect ratio will automatically change in auto mode.

### Color temperature

Select the option of color temperature by the above-mentioned way, then change its setting with left and right keys. The color temperature can be cool, nature, warm, user mode.

### Noise Reduction

Press up/down key to select "Noise Reduction" option. Press left/right key to select "Off", "Weak", "Middle", "Strong" and "Auto" to improve the picture sharpness.

## Sound

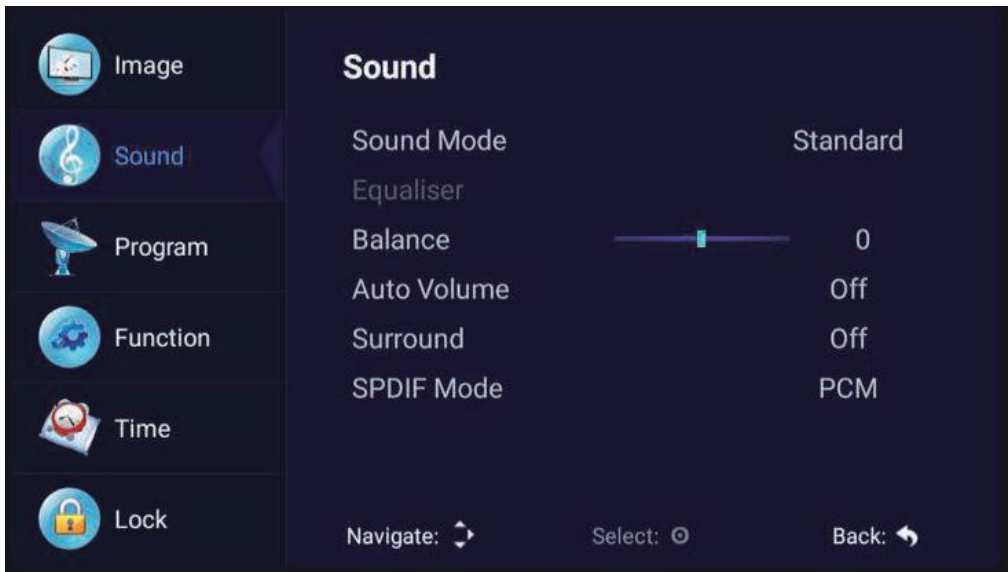

### Sound mode

Select the sound menu by using the up and down keys, press the right click "sound mode" option, and press the left and right buttons to switch the sound mode to music / movie / motion / user.

### Equalizer

Through the up and down keys selected "equalizer" option, and then press the OK key system will appear different bandwidth frequency level.

### Balance

If the volumes of the left speaker and the right speaker are not the same, you can adjust the "Balance" to suit your personal preference.

### Auto Volume, Surround

Select the automatic volume control options, after the key about to open or close the automatic volume control function, this method is also suitable for adjusting the surround sound.

### SPDIF Mode

This is used to select "SPDIF Mode". This option is only used in HDMI/DTV mode.

## Program

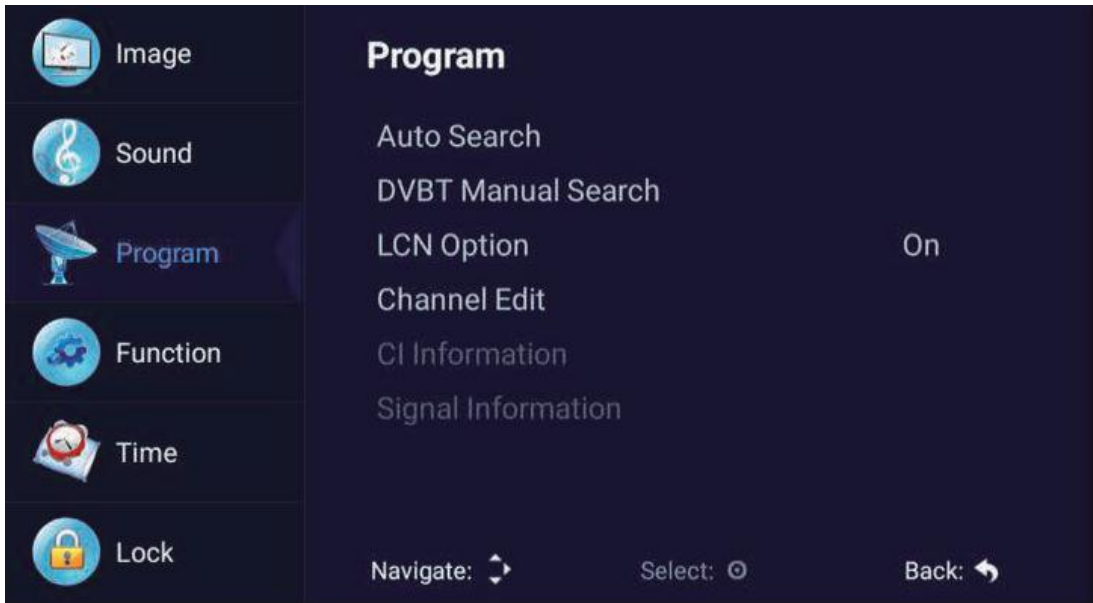

## DVB-T Auto Search

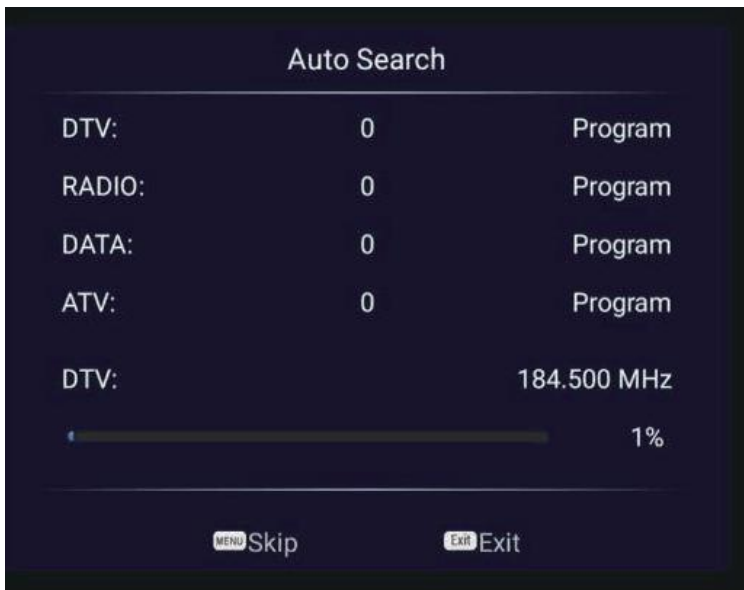

Select option of Auto Tuning under the up and down keys .Then press OK button and the auto tuning will begin.

## DTV Manual Search



To simulate the manual search, choose a good storage to Taiwan, you need, you can also choose color and sound format, press the arrow keys to select "search" option, and press left key can search, but also by fine tuning the frequency changes, select the best frequency.

## DTV-S Auto Search

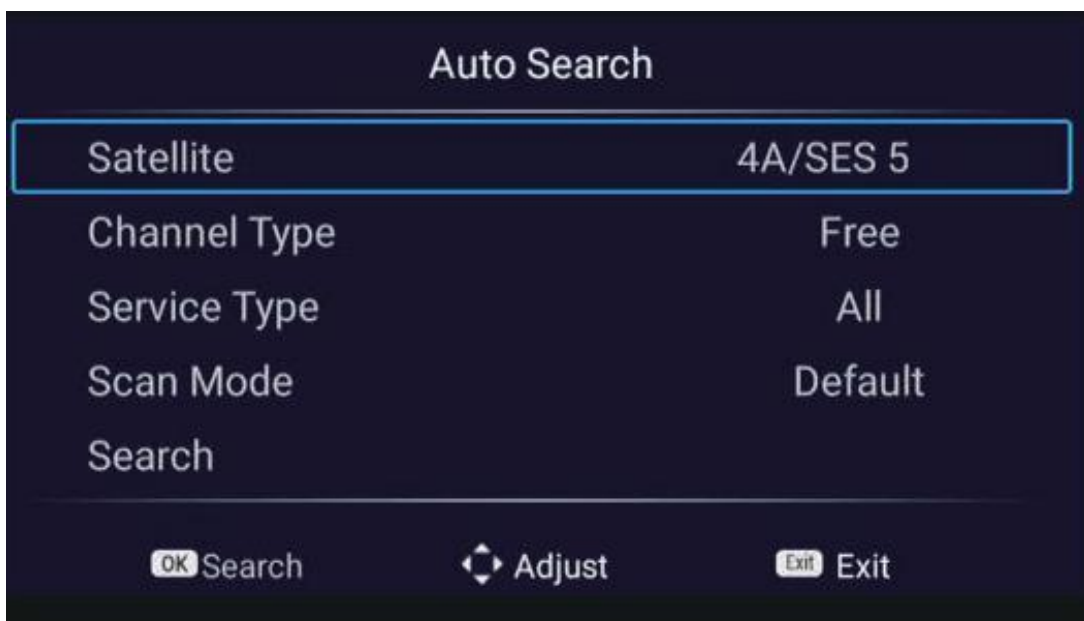

### Satellite

Select the appropriate satellite according to the local satellite model.

### Channel Type

Choose the Satellite type.

### Service Type

Satellite Service type

### Scan Mode

Satellite Scan Mode.

### DTV-S Manual Search

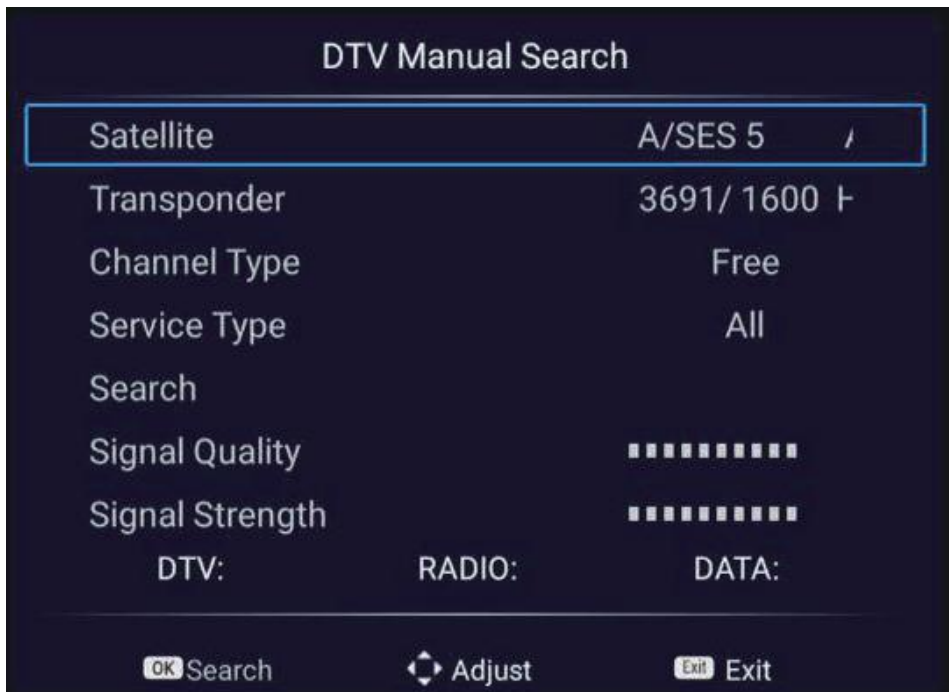

### Satellite

According to local satellite model, the satellite model selection.

### Transponder

Describes an effective program source with frequency symbol rate and polarization components.

## Function

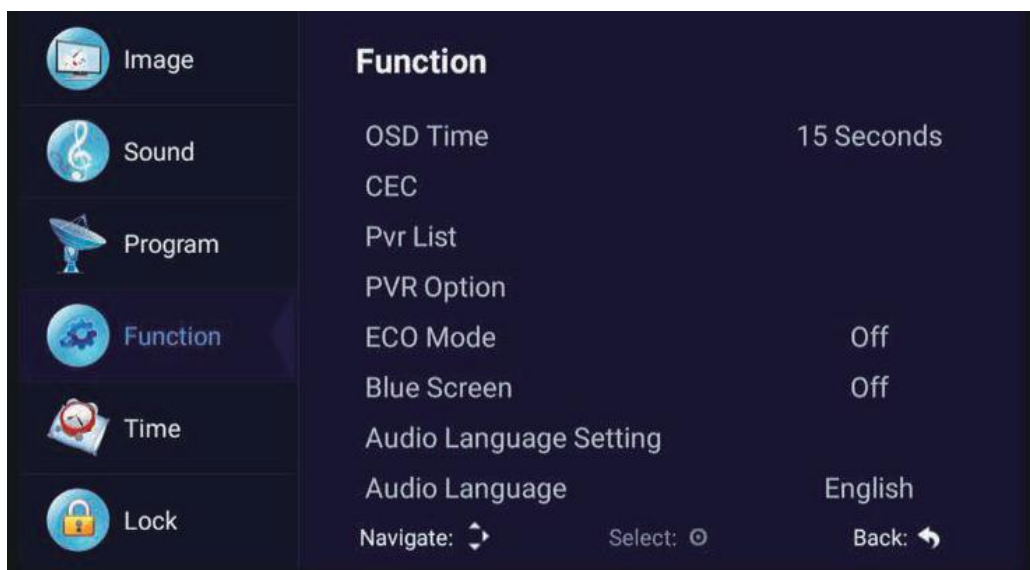

### OSD Time

Press the "menu display time" option, through the left and right direction keys can be changed to 5 seconds, 10 seconds, 15 seconds, 20 seconds, 30 seconds, always optional

### CEC

Press up and down key to select the option, and then open or close by the left and right CEC function. When cec opens, you can choose to turn on or off Auto Standby, Auto Power on, ARC, Device List, TV shutdown, CEC devices will also automatically shut down.

### Reset

Select the "restore default settings" option by using the up and down keys, and then click OK to enter the next window. Can choose to confirm or cancel, choose to confirm the television will restart, the menu data will restore the initial data, choose to cancel also back to the menu interface.

## Time

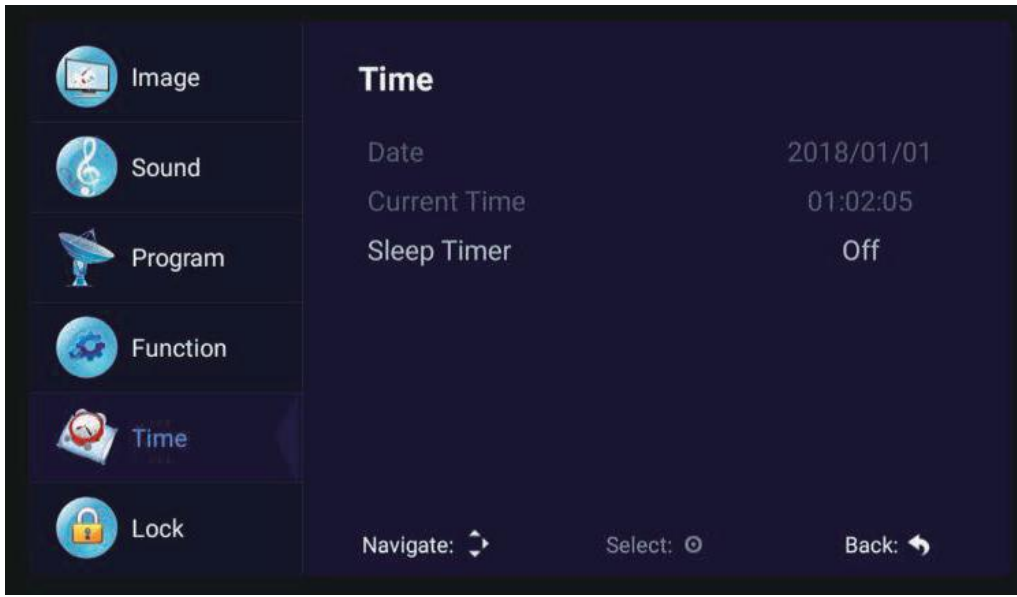

### Date, Current time

This is not adjustable, when there is a signal when the automatic calibration.

### Sleep time

The system provide many options of sleep time.

### Lock

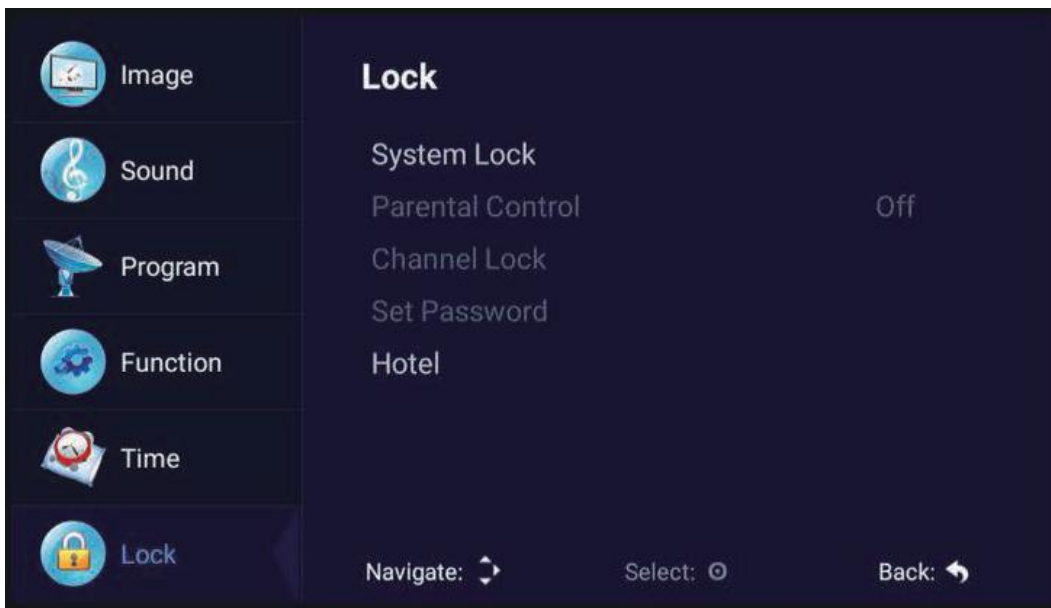

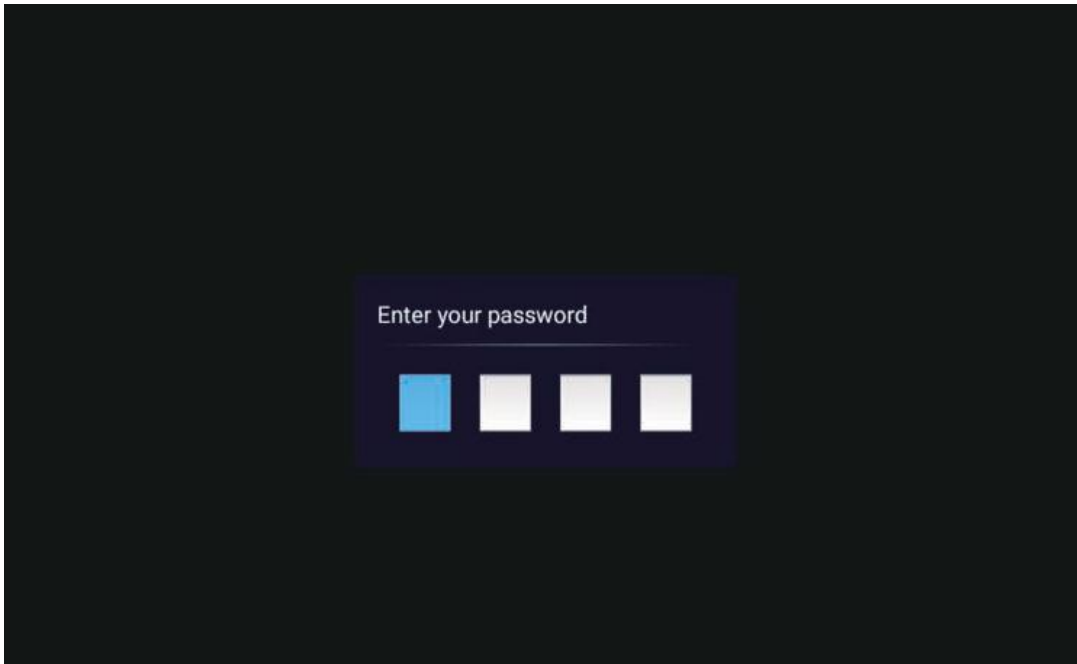

Choose the option of Lock System with the up and down keys .Then open the lock function with left and right keys. Please remember that initial password is 0000.If you want to adjust password, you firstly should select option of set password and then input old password, new password. you successfully reset password. When you want to shield some programs you don' t like, please select the option of block program and input the channel number.

### **Hotel mode**

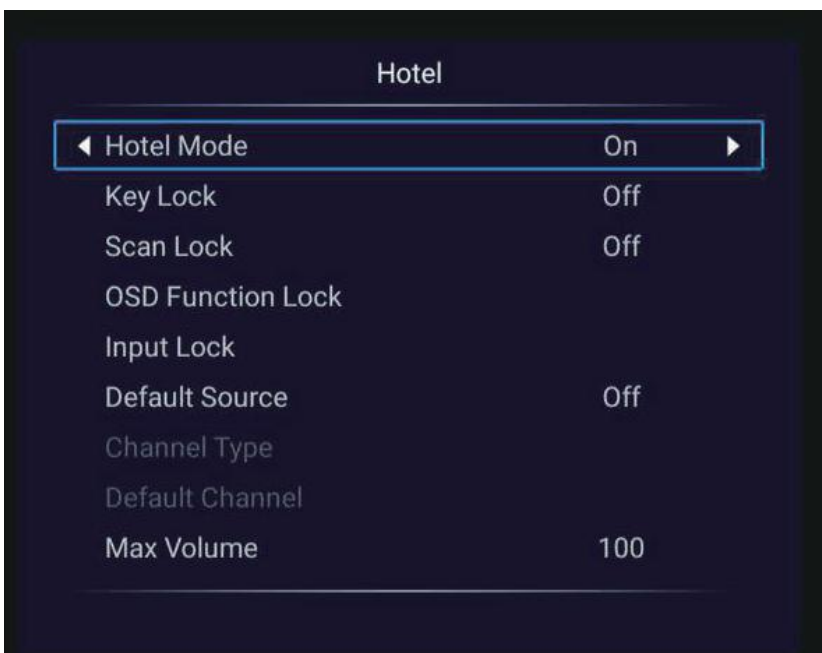



In the mode, you can manage the opening and closing of the relevant channels, set the language, screen ratio operation

### **Key lock**

Press the “key lock ” option to turn the menu on or off through the left and right keys.

### **Scan lock**

Press the “Scan lock ” option to turn the menu on or off through the left and right keys.

### **Input lock**

Press the “input Lock” option to turn the signal channel on or off through the left and right up and down keys.

### **Default Source**

Press the “Default Source” option to turn the menu on or off through the left and right keys.

### **Max Volume**

Press to select the “max volume ” option and set the parameters through the left and right keys.

### **Default Volume**

Press to select the “default volume ” option and set the parameters through the left and right keys.

### **Import**

Insert U disk, U disk place related files, click Import data.

### **Export**

Insert U disk, click option, export hotel data to U disk.

### **language**

Press the “language” option to turn the Select the language with the up and down arrow keys.

### **Aspect Ratio**

Press the “Aspect Ratio” option to set the parameters through the left and right keys.

### **Restore**

Press the “Restore” option to reset the above settings.

### 3. Media

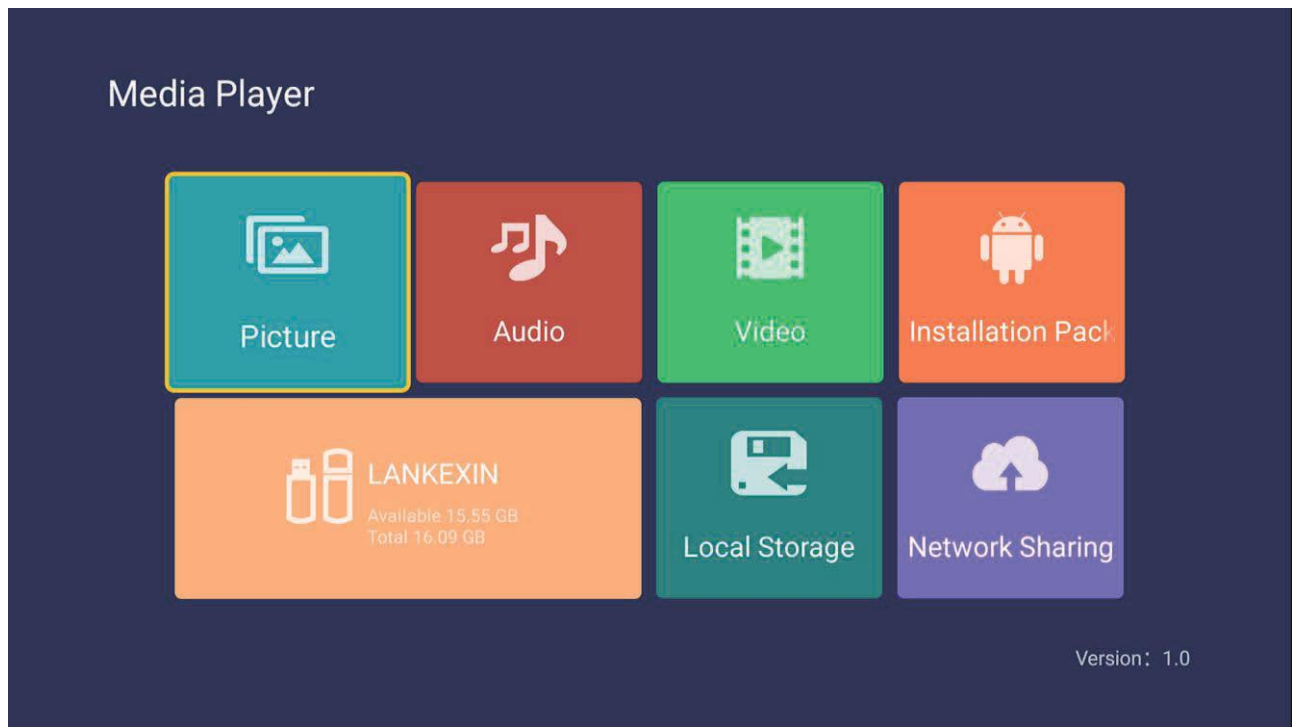

#### Picture

Through the up and down keys to select the "picture" icon, press the confirmation button to confirm, and then press right to the folder, press the confirmation button to open the appropriate folder. After selecting the picture, press the confirmation key to open the picture, can carry on some operation through the left and right keys.

#### Music

Through the up and down keys to select the "song" icon, press the confirmation button to confirm, and then press right to the folder, press the confirmation button to open the appropriate folder. After selecting the song, press the confirmation key to open the song, you can make some operation through the left and right keys.

#### Video

Through the upper and lower keys selected "video" icon, press the confirmation key to confirm, then press right to the folder, press the confirmation key to open the corresponding folder. After the selection of the video, press the confirmation key to open the video, you can make some operation through the left and right.

## 4. Android

### Home



The main page uses Zeasn UI design and is divided into: WHAT'S NEWS, APPS, MUSIC, Sports  
\*Different regions will receive different push content

### Settings

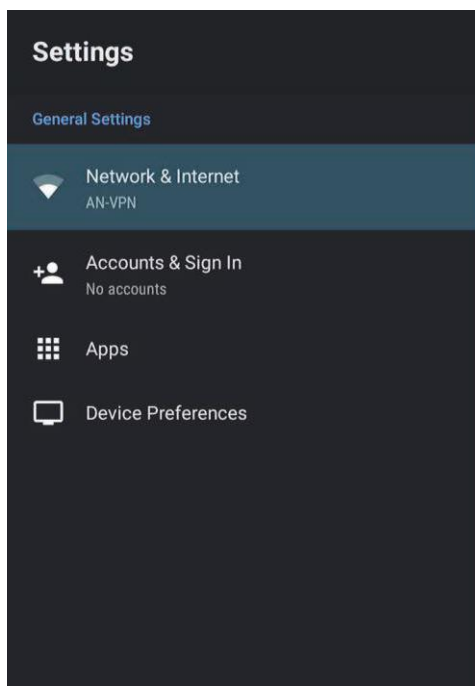

Pick the image of setting and Press OK button to appear the interface of the android setting.

The following is a brief description of the function of each menu .

## Network

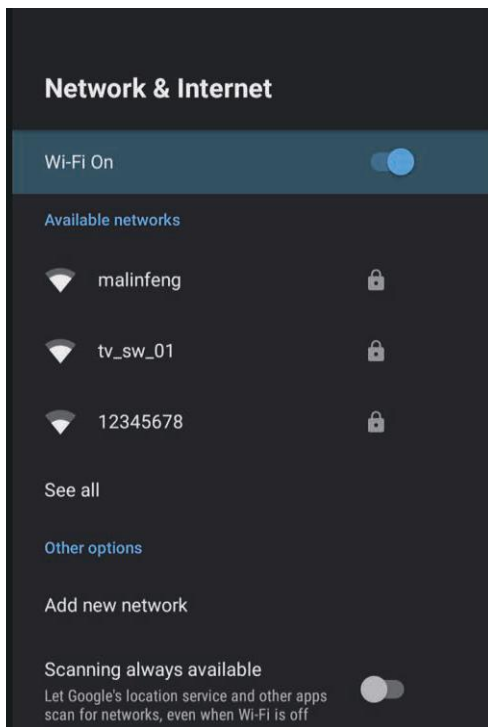

Enter the "Network" menu item "Wi-Fi", you can open or close the Wi-Fi connection function, there are 4 types of connection: select focus and enter the password in the list of connections, use without-password protected connection, manually add hot name to connect, and point-to-point direct connection.

## Sound

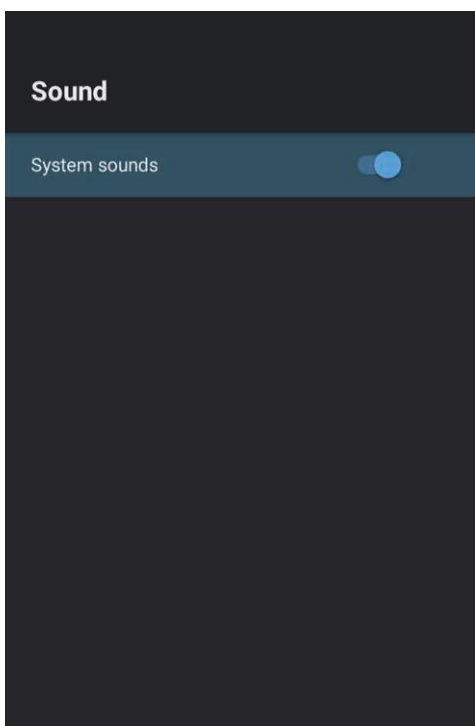

Set key tone

## Apps

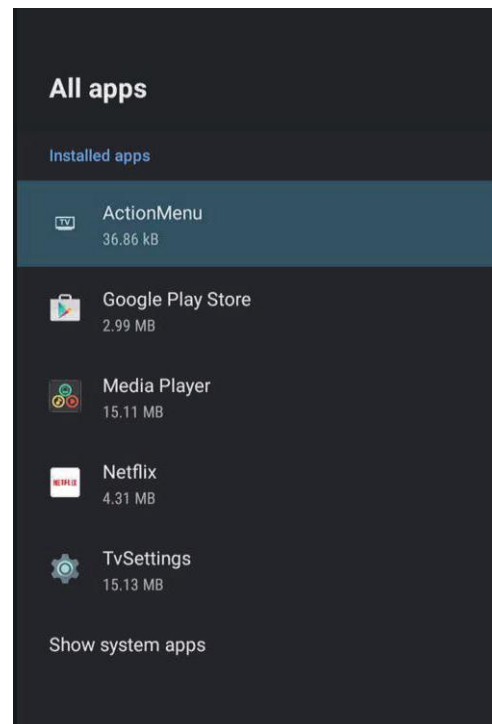
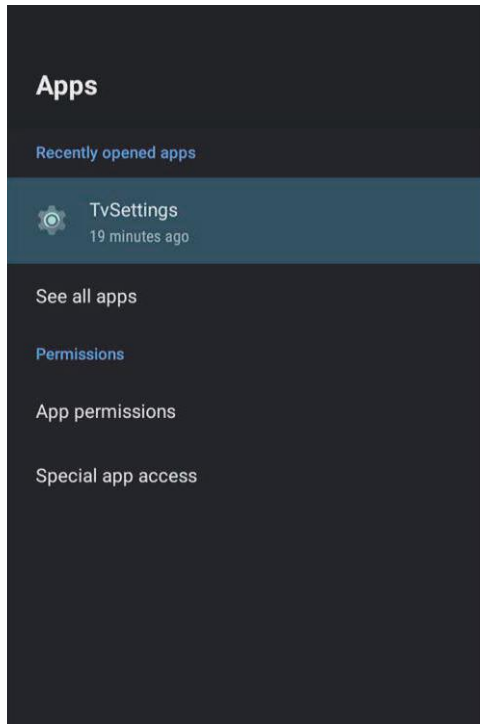

In the menu, you can view the application of the installation, running applications and all of the application.

## reset

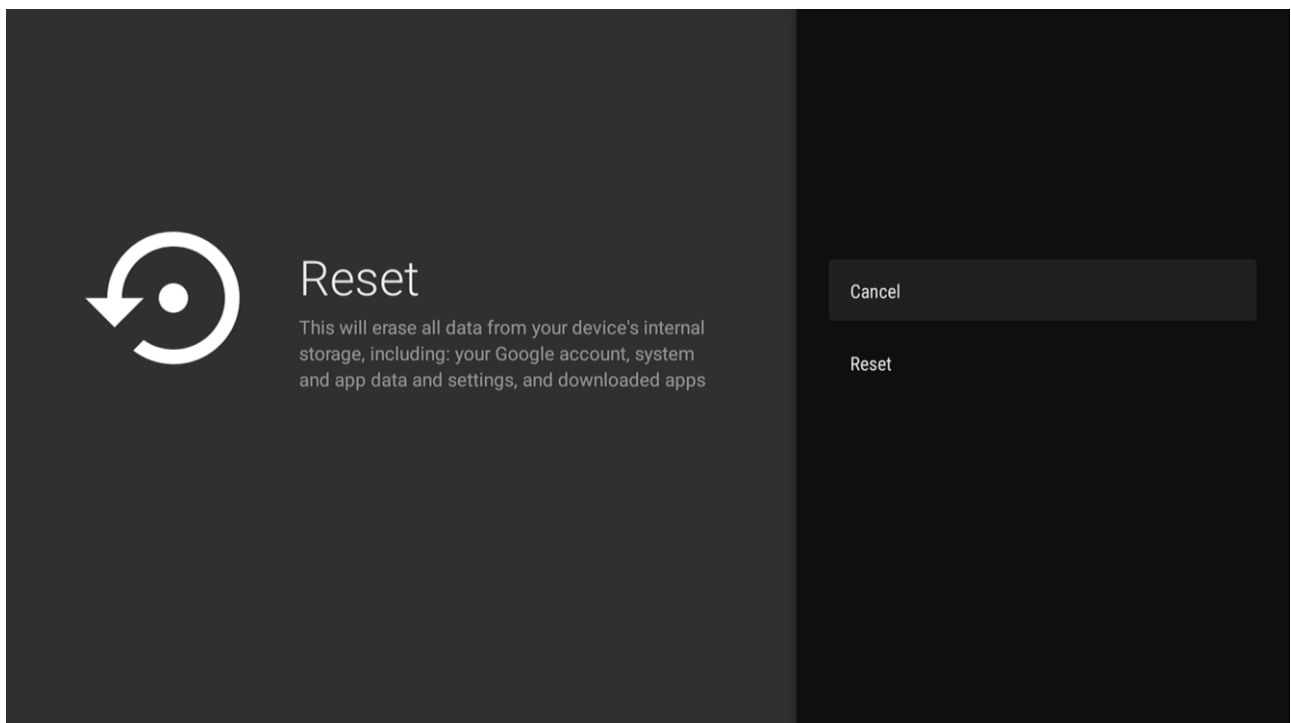

Here you can view the details of the internal storage space and the use of SD card , and in the option of backup & reset, you can do factory data reset . After resetting, the data on TV will be erased. For system update ) .

## About

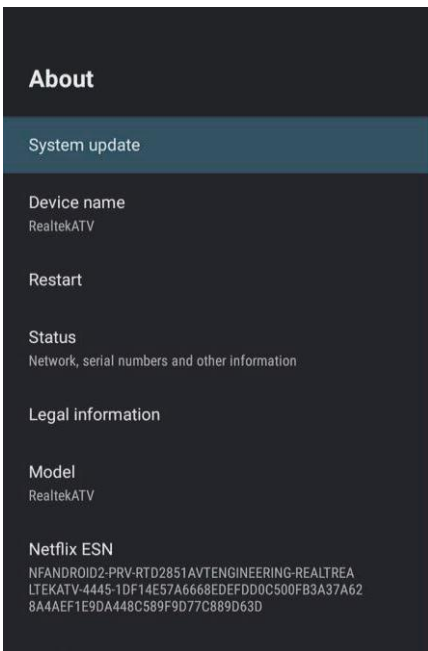

You can view and set the relevant information for the OTA update, you can also view the model, Android version, version number information.

## Date & Time

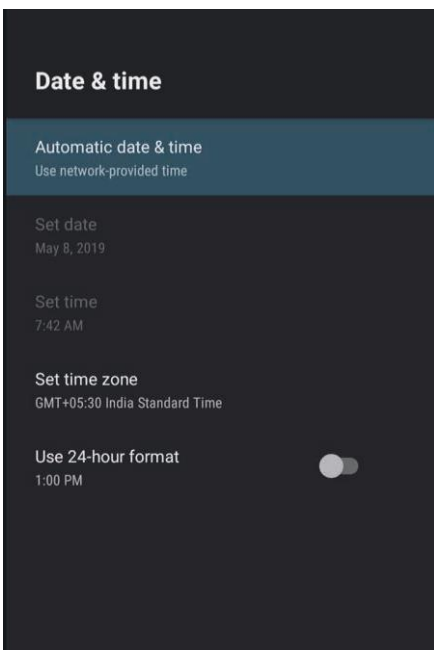

In this part, you can modify the date and time, and also choose to synchronize with the date & time of the network.

## Language

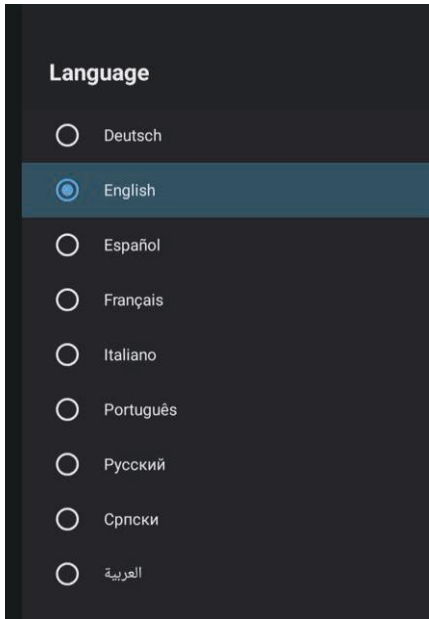

System language can be selected here.

## Keyboard



Users can be based on personal preferences of the keyboard input settings, you can also view the personal dictionary.

# HELP

No power	<ul style="list-style-type: none"> <li>• Check if the AC cord of TV is plugged in or not. If there's still no power, please disconnect the plug, and reconnect to the socket after 60 seconds. Turn the power back on.</li> </ul>
Signal not received properly	<ul style="list-style-type: none"> <li>• Double or phantom images may appear on your TV if there are high buildings or mountains close to where you are. You can adjust the image thru manual operation: consult instruction of vernier regulation, or adjust the direction of the external antenna.</li> <li>• If you use an indoor antenna, under certain circumstances signal reception may be more difficult. Adjust the direction of the antenna for optimum reception. If this does not improve reception, you may have to switch to an external antenna.</li> </ul>
No picture	<ul style="list-style-type: none"> <li>• Check if the antenna at the back of the TV is connected properly.</li> <li>• View other channels to see if the problem still occurs.</li> </ul>
Video appears with no audio	<ul style="list-style-type: none"> <li>• Try increasing the volume.</li> <li>• Check if the TV's sound is on mute or not.</li> </ul>
Audio is present, but video does not appear or is discolored	<ul style="list-style-type: none"> <li>• Try adjusting the contrast and brightness.</li> </ul>
Static noise affects video and audio quality	<ul style="list-style-type: none"> <li>• Check if the antenna at the back of the TV is connected properly.</li> </ul>
Broken lines on screen	<ul style="list-style-type: none"> <li>• Electrical appliances such as hair dryers or vacuums etc. may be interfering with your TV set. Switch these appliances off.</li> </ul>
Remote doesn't work	<ul style="list-style-type: none"> <li>• Make sure the plastic bag which came with the remote control is removed. Try using the remote in a shorter distance from the TV. Check if the placement of the batteries is correct, or try using new batteries with the remote control.</li> <li>• The TV will go into Standby mode if it receives no response in a few minutes.</li> </ul>
No video (PC mode)	<ul style="list-style-type: none"> <li>• Please check if the cable is connected to the VGA port correctly, or if the cable is bent in some places.</li> </ul>
Vertical line blinking (PC Mode)	<ul style="list-style-type: none"> <li>• Enter the main menu, and adjust the vertical placement to eliminate the vertical line.</li> </ul>
Horizontal tearing (PC Mode)	<ul style="list-style-type: none"> <li>• Adjust the horizontal placement of the screen to clear any horizontal lines.</li> </ul>
Screen is too bright or dark (PC Mode)	<ul style="list-style-type: none"> <li>• Adjust the brightness or contrast in the main menu.</li> </ul>
No response from the PC	<ul style="list-style-type: none"> <li>• Check if the PC's display resolution is set to a compatible resolution for the TV.</li> </ul>
Lines appearing when a device is connected to the RCA port	<ul style="list-style-type: none"> <li>• Make sure you are using a cable of good quality.</li> </ul>
Problems are unresolved	<ul style="list-style-type: none"> <li>• Unplug the power cable and wait for 30 seconds, then reconnect to the socket. If problems still persist, do not attempt to repair the TV by yourself. Kindly contact the service center.</li> </ul>

Do not leave your TV displaying a static image, whether it is from a paused video, menu screen, etc. for an extended period of time, doing so will damage the display and may cause image burn-in.



## SPECIFICATIONS

<b>Aspect Ratio</b>	16 : 9
<b>System</b>	PAL/SECAM BG/DK/I, DVB-T/T2+C , NTSC Playback
<b>Base impedance</b>	75Ω (Unbalance)
<b>Receiving TV Band</b>	All Channels Receiveable
<b>AC Supply Voltage</b>	100-240V~ 50/60Hz

**Note:** Part of the design and the specification may be changed without prior notice.

### INFRA-RED REMOTE CONTROL

**Features:** Full function remote control

**Effective Distance Power:** 8 metres

**Power Supply:** DC 3V (Two batteries, size AAA, recommend use alkaline type batteries)



Manufactured under license from Dolby Laboratories. Dolby, Dolby Audio, Pro logic, and the double-D symbol are trademarks of Dolby Laboratories.

	Operation Frequency	Transmitting Power
WiFi	2412-2472MHz	Less Than 100mW

NOTE:

DO NOT SUPPORT ALL MOBILE DEVICES THE TV FUNCTION WIRELESS DISPLAY.  
PLEASE KEEP YOUR OWN MOBILE DEVICE SUPPORT TO THIS FUNCTION.

# REMOTE CONTROLLER

The remote controller cannot be used unless it is within the receivable range. Before you use the remote control, please make sure there's no obstacle between the remote control and the receiver.

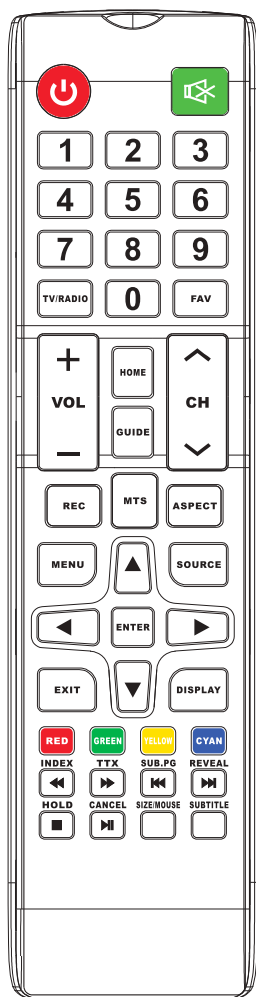

1. **POWER:** Turn on the TV or enter standby mode.
2. **MUTE:** Turn off the sound and turn on when press again.
3. **0-9:** Figures "0-9" are used to directly input channel number.
4. **MTS:** Press to select the MTS mode.(for example,Nicam , BTSC MONO STEREO eg )
5. **MENU:** Start system menu and return to upper menu.
6. **SOURCE:** Input source selection button.
7. **▲▼◀▶** Press ▼▲ button to select items.  
Press ◀▶ button to adjust it.
8. **ENTER:** To confirm the choice with the highlighted menu item.
9. **EXIT:** Press to exit the OSD menu.  
**DISPLAY :** Press to display the source and channel's display.
10. **VOL+:** Increase the volume.
11. **HOLD:** HOLD On or Off for current page display .
12. **VOL-:** Decrease the volume.
13. **PLAY/PAUSE:** Press to PLAY/PAUSE in the USB mode. start play and PAUSE ,in USB mode.
14. **CANCEL:** When a page is selected in the mode of text, it may take some time before it becomes available, pressing the CANCEL key will return to the TV mode. When the required page is found , the page number will appear at the top of the TV picture, press the CANCELkey to return to the mode of text for you to browse this page.
15. **TV/RADIO :**When watching channel, allows you to switch between TV and Radio modes.
16. **STOP:** Press to STOP in the USB mode.
17. **CH+:** Increase the program.
18. **HOME:** A key back to the android home page.
19. **CH-:** Decrease the program.
20. **ASPECT:** Aspect function.
21. **MOUSE:** Mouse switch.
22. **SIZE:** Change the size of display in Teletext mode.
23. **SUBTITLE:** To display subtitle in USB mode.
23. **REC:** Record begin in PVR mode.
24. **GUIDE:** Launches the EPG (Electronic Program Guide)
25. **FAV:** Press to add or remove your favorite channels under tv menu.
26. **FF:** Press to fast forward in USB mode.
27. **TTX:** Switch the teletext on and off.
28. **PREV:** Press to skip backwards in USB mode
29. **SUB. PG :** Press to access sub page.
30. **FR:** Press to fast reverse in USB mode.  
**INDEX:** Request the Index page in Teletext mode.
31. **NEXT:** Press to skip forward in USB mode.  
**REVEAL:** Reveal or Hide the hidden words.

# ENVIRONMENTAL PROTECTION



## Attention!

Your product is marked with this symbol. It indicates that it should not be disposed of with other household waste at the end of its working life. Any used electronic or electric equipment should be separated from the general waste and recycled responsibly according to the act on responsible waste disposal.

Following the implementations of the EU provisions concerning the responsible waste disposal, household users can return all used electronic and electric equipment to the indicated electronic waste collection points free of charge. When purchasing a new

Contact your local government office to receive more information.

If the product has batteries, please remove them as required by law.

A proper disposal of electric and electronic waste promotes the sustainable reuse of material resources and recycling. In this way you prevent possible harm to the environment or human health.

Uncontrolled electric and electronic waste disposal can cause harm to the environment.

### Information for business users in EU countries

If the product you want to be disposed of was used for business purposes, please contact your dealer to obtain information on the way of its collection, disposal and recycling as well as on possible costs. If you want to dispose of a small unit, it can be returned to the local electronic waste collection point.

### Information for business users in non-EU countries

If you want to dispose of the used product, please contact your local government office to obtain information on appropriate form of recycling.



**FOX**<sup>®</sup>  
be smart

# UPUTSTVO ZA UPOTREBU

## LED TELEVIZORI

Model:43DLE788

Hvala Vam što ste kupili ovaj uređaj.

**FOX LED** televizori prepoznaju se po odličnim tehničkim karakteristikama, kao i modernom, funkcionalnom i elegantnom dizajnu. Osim toga konstantna unapređenja u vidu postprodajne podrške, izuzetno efikasna i rasprostranjena servisna mreža čine da se ponosni vlasnici **FOX televizora** mogu osećati sigurno.

**Napravili ste pravi izbor.**

U nastavku slede uputstva za upotrebu. Nisu komplikovana, ali ih se morate pridržavati.



Android™OS

EN

SR

## SADRŽAJ

BEZBEDNOSNE INFORMACIJE .....	3
VAŽNE BEZBEDNOSNE INSTRUKCIJE .....	4
TASTERI I PRIKLJUČCI TV-A .....	5
ŠEMA POVEZIVANJA SPOLJNIH UREĐAJA .....	6
POSTAVLJANJE I POVEZIVANJE TV-A .....	7
POSTAVLJANJE STALKA ZA TV .....	8
MENI NA EKRANU .....	9
POMOĆ .....	25
SPECIFIKACIJE .....	26
DALJINSKI UPRAVLJAČ .....	27
ZAŠTITA ŽIVOTNE SREDINE .....	28



## BEZBEDNOSNE INFORMACIJE

### MERE OPREZA

#### RIZIK OD STRUJNOG UDARA NE OTVARATI

Tokom rada ovog proizvoda u njemu je prisutan visok napon. Da biste smanjili rizik od strujnog udara, nemojte sami otvarati uređaj, a servisiranje prepustite kvalifikovanim serviserima

Ako primetite promene na TV-u ili da ga je teško podesiti, ne pokušavajte da otvorite uređaj radi popravke jer može doći do strujnog udara; predajte uređaj servisu radi popravke.

	<p>Uzvičnik u jednakostraničnom trouglu obaveštava korisnika da uputstva treba da potraži u dokumentaciji koju je dobio uz uređaj.</p>
	<p><b>Upozorenje</b> Simbol munje sa strelicom u jednakostraničnom trouglu obaveštava korisnika o prisustvu neizolovanog opasnog napona unutar kućišta proizvoda, koji bi mogao da izazove strujni udar.</p>

## VAŽNE BEZBEDNOSNE INSTRUKCIJE

- 1) Pročitajte ovo uputstvo.
- 2) Sačuvajte ovo uputstvo.
- 3) Poštujte sva upozorenja.
- 4) Pratite sva uputstva.
- 5) Ne koristite aparat u blizini vode.
- 6) Čistiti isključivo suvom krpom.
- 7) Ne blokirajte ventilacione otvore. Postaviti prema uputstvima proizvođača.
- 8) Ne postavljati blizu izvora toplote, poput radijatora, grejalice, šporeta i drugih aparata (uključujući pojačivače) koji odaju toplotu.
- 9) Ne gubite iz vida zaštitnu ulogu polarizovanog utikača, odnosno utikača sa uzemljenjem. Polarizovani utikač ima dve viljuške, od kojih je jedna šira. Utikač sa uzemljenjem ima dve viljuške i jednu iglu za uzemljenje. Široka viljuška, odnosno igla za uzemljenje, služi da vas zaštiti; ako se isporučeni utikač ne uklapa u vaše utičnice, angažujte električara da vam zameni utikač odgovarajućim.
- 10) Zaštite kabl za napajanje od gaženja ili prikleštenja, posebno kod utikača, razvodnih kutija i na mestu gde izlazi iz uređaja.
- 11) Koristite isključivo dodatke/pribor koje je odobrio proizvođač.
- 12) Koristite isključivo u kombinaciji sa kolicima, stalkom, tronošcem, držačem ili stolom kakav propisuju specifikacije proizvođača ili koji se prodaje uz ovaj aparat. Ako TV stoji na kolicima, budite pažljivi prilikom premeštanja kolica/aparata da ne bi došlo do povrede usled preturanja.



- 13) Isključite ovaj uređaj tokom oluja sa grmljavinom ili kada se ne koristi duže vreme.

Oprez:

- 14) Da biste smanjili rizik od požara ili strujnog udara, ne izlažite aparat kiši ili vlazi.
- 15) Strujni utikač služi kao uređaj za isključivanje, pa mora uvek da bude dostupan.
- 16) Mora se koristiti strujna utičnica koja se nalazi u blizini ovog uređaja i koja je lako dostupna.
- 17) Ovaj proizvod nikada ne treba ugrađivati, na primer u stalažu sa knjigama ili u policu, ako se ne obezbedi odgovarajuća ventilacija ili ako se ne ispoštuju uputstva proizvođača.
- 18) Uređaj ne treba izlagati kapanju ili prskanju i na njega ne treba postavljati nikakve predmete napunjene tečnošću, kao što su vaze.
- 19) Ne stavljajte izvore opasnosti na aparat (npr. predmete sa tečnošću, upaljene sveće).
- 20) Montaža na zid ili plafon – Ovaj aparat sme da se postavlja na zid ili plafon isključivo na način koji preporučuje proizvođač.



- 21) Nikada ne stavljajte TV, daljinski upravljač ili baterije u blizinu otvorenog plamena ili drugih izvora toplote, uključujući direktnu sunčevu svetlost. Da ne bi došlo do požara, sveće i drugi plamen uvek držite podalje od TV-a, daljinskog upravljača i baterija.
- 22) Jačina struje u USB priključku treba da iznosi 0,5 A u normalnim okolnostima. Ova uputstva za servisiranje namenjena su isključivo za korišćenje od strane kvalifikovanih servisera. Da biste smanjili rizik od strujnog udara, ne vršite servisiranje osim onog navedenog u uputstvu za upotrebu. Izuzetak se može napraviti ako ste kvalifikovani za to.
- 23) Baterije ne smeju biti izložene visokoj temperaturi, plamenu ni direktnoj sunčevoj svetlosti.
- 24)  Ova oprema spada u klasu II, odnosno u dvostruko izolovane električne uređaje. Projektovana je tako da ne zahteva bezbednosno povezivanje sa sistemom strujnog uzemljenja.
- 25) Maksimalna temperatura okoline za korišćenje iznosi 45 stepeni. Maksimalna nadmorska visina za korišćenje iznosi 2000 metara

## TASTERI I PRIKLJUČCI TV-A

### Tasteri TV-a

Napomena: Uputstva za tastere navedena su ispod.

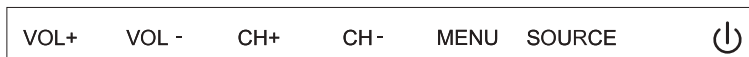

Prikazivanje/sakrivanje ikonica: Ako se ikonice ne prikazuju, pritisnite taster i ikonice će se prikazati kao što je prikazano iznad; ikonice će se automatski isključiti nakon 5 sekundi bez aktivnosti.

Biranje ikonice: Pritisnite i držite dati taster, pomerite udesno i izaberite ikonicu.

Biranje funkcije ikonice: Pritisnite i držite taster da biste aktivirali funkciju izabrane ikonice.

Opis ikonica

Znak za isključivanje: Isto kao taster „NAPAJANJE“ na daljinskom upravljaču.

Ikonica Meni: Isto kao taster „MENU“ na daljinskom upravljaču.

Ikonica Izvor: Isto kao taster „SOURCE“ na daljinskom upravljaču.

Ikonica Kanal+: Isto kao taster „CH+“ na daljinskom upravljaču.









Ikonica Kanal-: Isto kao taster „CH-“ na daljinskom upravljaču.

Ikonica Zvuk+: Isto kao taster „VOL+“ na daljinskom upravljaču.

Ikonica Zvuk-: Isto kao taster „VOL-“ na daljinskom upravljaču.

### Priključci

Napomena: Ispod su prikazani razni priključci, ali njihov stvaran položaj i razmeštaj mogu da se razlikuju u zavisnosti od modela.

	<b>AV ulaz</b> Ulaz za spoljni AV signal i levi/desni kanal za zvuk		<b>PC audio ulaz</b> VGA ulaz i ulaz za zvuk kada se koristi VGA ulaz
	<b>RJ45</b> Povezivanje na internet.		<b>Izlaz za slušalice</b> Kada su slušalice priključene, zvučnici ne rade
	<b>HDMI ulaz</b> Ulaz za digitalni signal iz HDMI video priključka.		<b>USB ulaz</b> Priključite USB uređaj ovde da biste puštali datoteke sa njega ili snimali programe pomoću funkcije PVR.
	<b>ANT75</b> Priključak za antenski kabl/kablovsku (75NHF/UHF)		<b>Optički ulaz</b> Priključak za SPDIF risiver.
	<b>VGA ulaz</b> Ulaz za analogni signal sa računara		



## ŠEMA POVEZIVANJA SPOLJNIH UREĐAJA

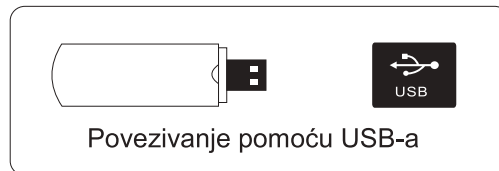
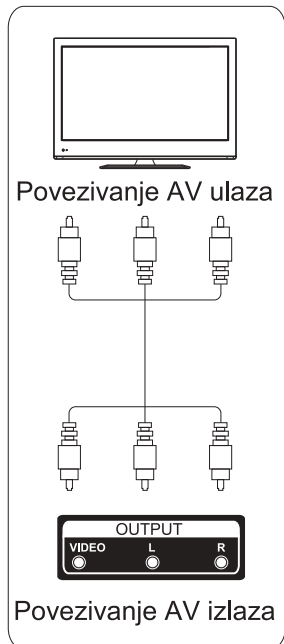
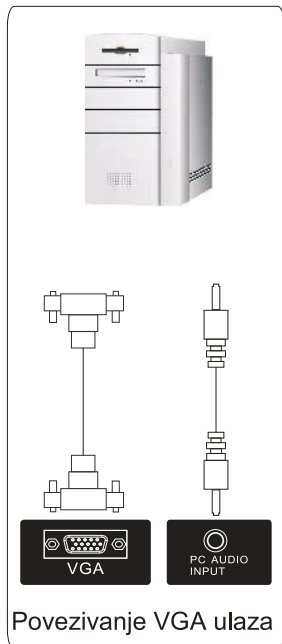
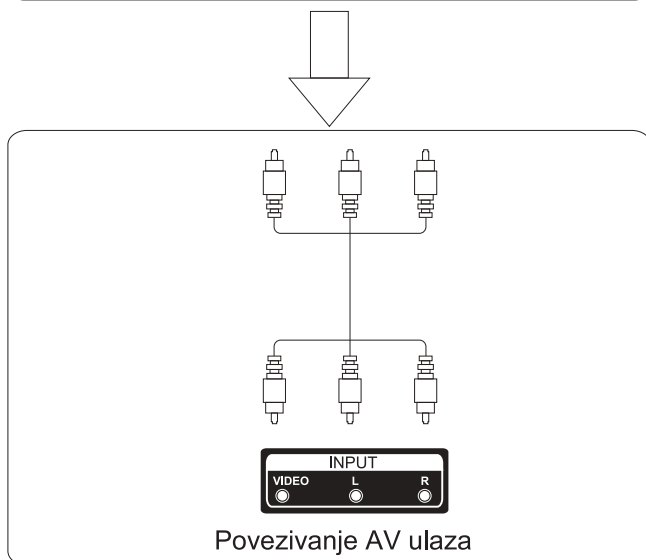
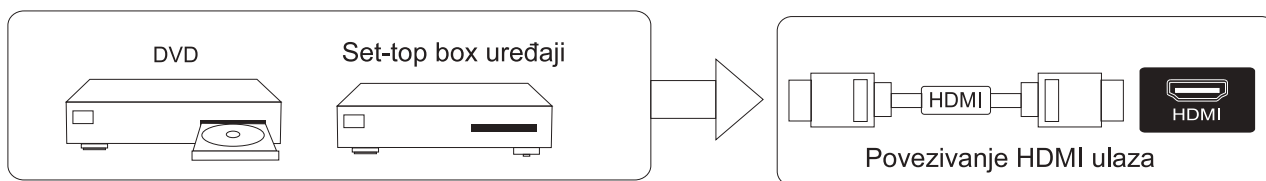

### NAPOMENA

AKO ĆETE NA TELEVIZORU GLEDATI KABLOVSKU TELEVIZIJU, PROVERITE KOMPATIBILNOST I POTENCIJAL KABLOVA SA OPERATEROM KABLOVSKE MREŽE. TE PODATKE ZATRAŽITE OD OPERATERA KABLOVSKE MREŽE.

## POSTAVLJANJE I POVEZIVANJE TV-A

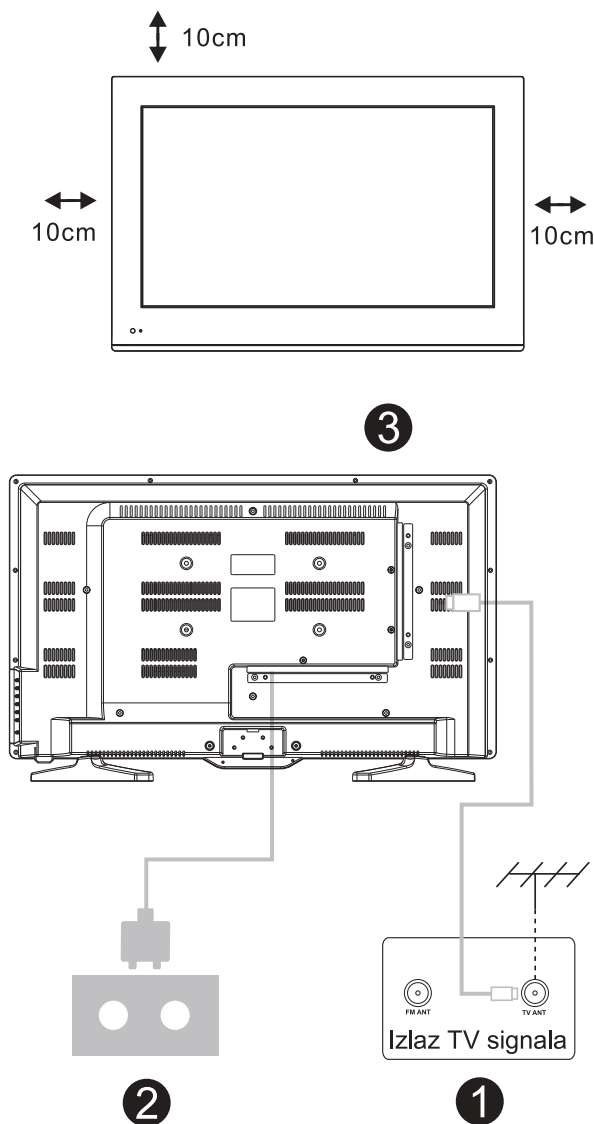

### Postavite TV

Stavite TV na čvrstu površinu koja može da nosi težinu TV-a.

Da ne bi došlo do opasnih situacija, ne stavljajte TV blizu vode ili grejnih tela (poput lampi, sveća, grejalica) i ne blokirajte ventilacione otvore sa zadnje strane TV-a.

### Povežite antenski kabl i strujni kabl

1. Priključite antenski kabl u priključak za antenu sa zadnje strane TV-a.
2. Priključite strujni kabl TV-a (AC 100–240 V, 50/60 Hz).

### Uključite TV

3. Pritisnite dugme za uključivanje na TV-u i indikatorska lampica će zasijati zeleno, ako je u režimu mirovanja (lampica sija crveno), pritisnite dugme za uključivanje na daljinskom upravljaču da biste uključili TV.

### Napomena:

Slika je navedena isključivo u referentne svrhe.

## POSTAVLJANJE STALKA ZA TV

1. Otvorite kartonsko pakovanje i izvadite TV, dodatnu opremu i postolje (neki modeli nemaju postolje).
2. Da ne bi došlo do oštećenja TV-a, pokrijte sto mekom tkaninom i stavite TV na sto, prednjom stranom okrenutom nadole ka tkanini; pričvrstite vrat postolja za TV pomoću zavrtnjeva.
3. Postavite postolje i spojite ga za TV.
4. Montaža je gotova.

### Napomena:

Slika je navedena isključivo u referentne svrhe.

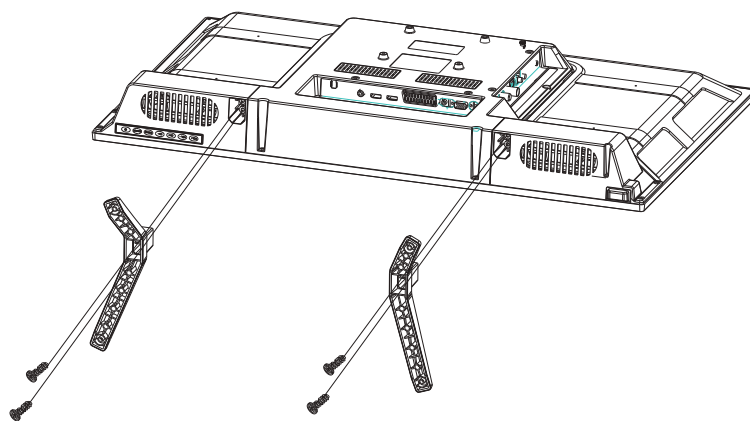

## MENI NA EKRANU

### 1. IZVOR

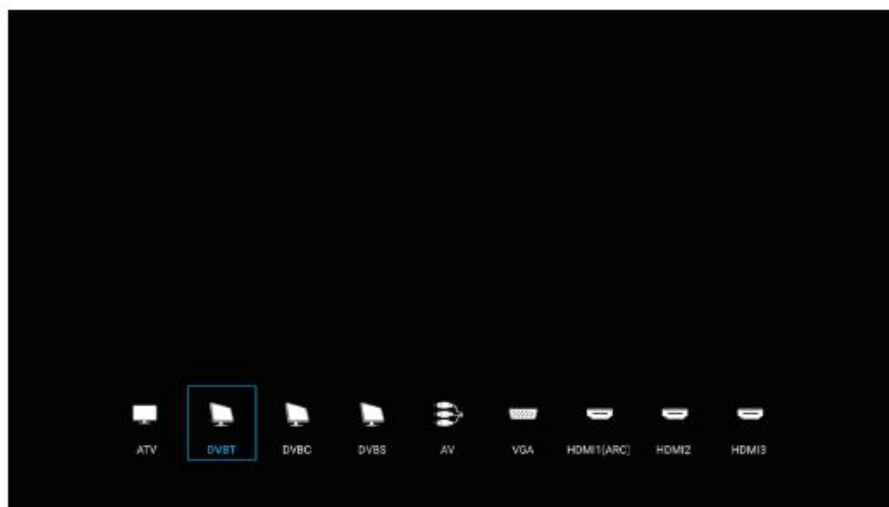

Pomoću dugmeta „SOURCE“ otvorite meni za biranje izvora signala, izaberite izvor ulaza signala, pa pritisnite dugme za potvrdu da izaberete željeni izvor signala.

### 2. MENI TV-A

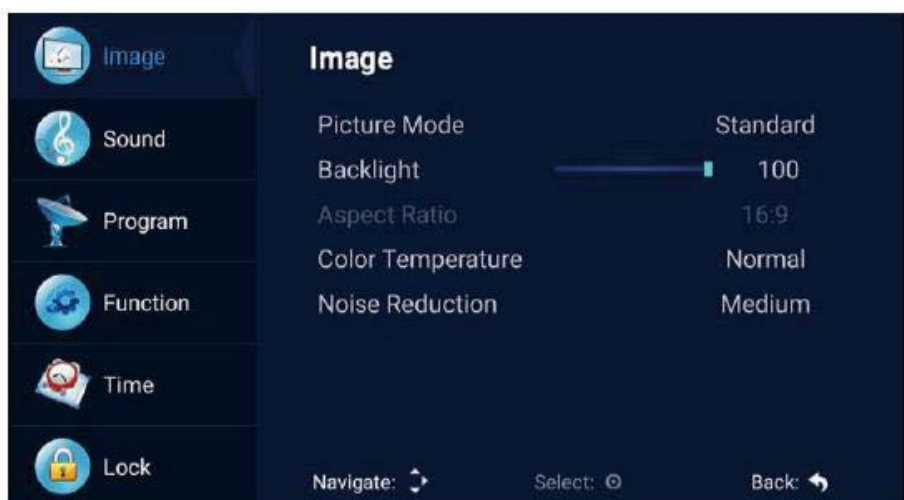

Pritisnite dugme „MENU“ da biste otvorili meni, pomoću strelica nagore i nadole izaberite odgovarajuća podešavanja, pa pritisnite strelicu udesno da biste ušli u odgovarajuća podešavanja, npr: Slika, Zvuk, Program, Funkcija, Podešavanje vremena, Zaključavanje.

## Slike

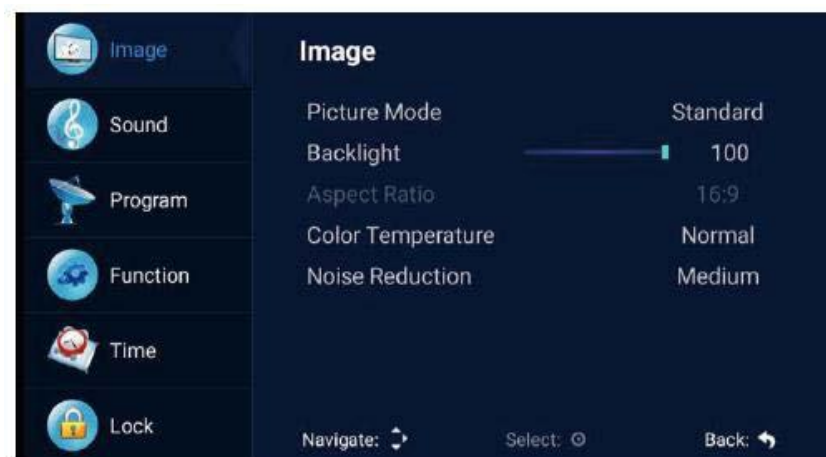

### Režim slike

Izaberite meni za sliku pomoću strelica ulevo i udesno, pa pritisnite dugme OK za sledeću radnju. Ovu stavku zatim možete birati pomoću strelica nagore i nadole. Režim slike može da se menja na standardni/mekei/svetli/specijalni korisnički.

### Pozadinsko osvetljenje

Podešavanjem pozadinskog osvetljenja menjate osvetljenost pozadine.

### Razmera

Dostupne opcije su ZOOM1, ZOOM2, 16:9 i 4:3, koje birate strelicama ulevo i udesno kada se izabere opcija „Aspect Ratio“. Razmera se automatski menja kada je aktivan automatski režim.

### Temperatura boja

Izaberite opciju „Color Temperature“ na iznad opisani način, pa promenite podešavanja strelicama ulevo i udesno. Temperatura boja može da bude Hladno, Priroda, oplo, Korisnički režim.

### Smanjenje šuma

Pritiskanjem strelica nagore/nadole izaberite opciju „Noise Reduction“. Pritiskanjem strelica ulevo/udesno izaberite „Off“, „Weak“, „Middle“, „Strong“ i „Auto“ da biste povećali oštrinu slike.

## Zvuk

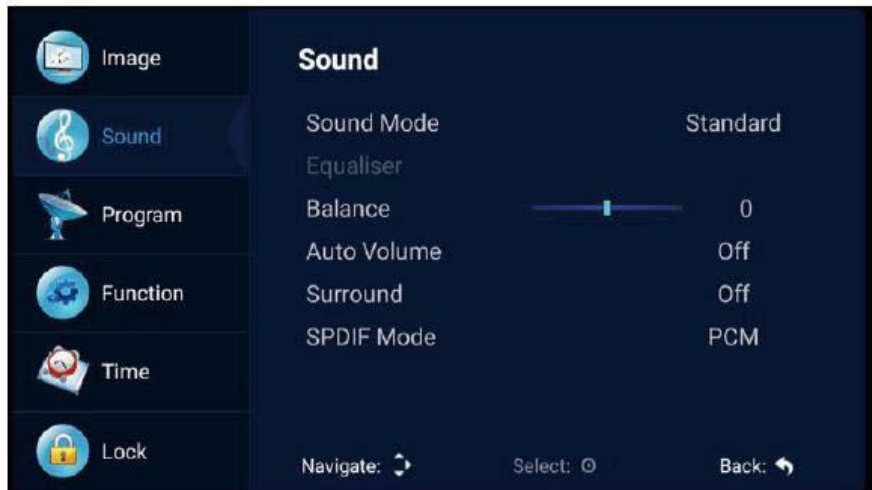

### Režim zvuka

Izaberite meni za zvuk pomoću strelica nagore i nadesno, pritisnite strelicu udesno da biste ušli u odeljak „Sound Mode“, pa pritiskanjem strelica ulevo i udesno promenite režim zvuka na Muzika / Film / Brzi pokreti / Korisnički režim.

### Ekvilajzer

Pomoću strelica nagore i nadole izaberite opciju „equalizer“, pa pritisnite OK; pojaviće se meni sa različitim nivoima opsega frekvencija.

### Balans

Ako jačine zvuka iz levog i desnog zvučnika nisu iste, možete da podesite „Balance“ kako vama odgovara.

### Automatska jačina zvuka, Surround

Možete da izaberete opciju automatske kontrole jačine zvuka pritiskom na dugme koje otvara ili zatvara funkciju automatske kontrole zvuka; ovaj metod služi i za podešavanje Surround zvuka.

### SPDIF režim

Ovo služi za biranje „SPDIF Mode“. Ova opcija se koristi samo sa režimom HDMI/DTV.

## Program

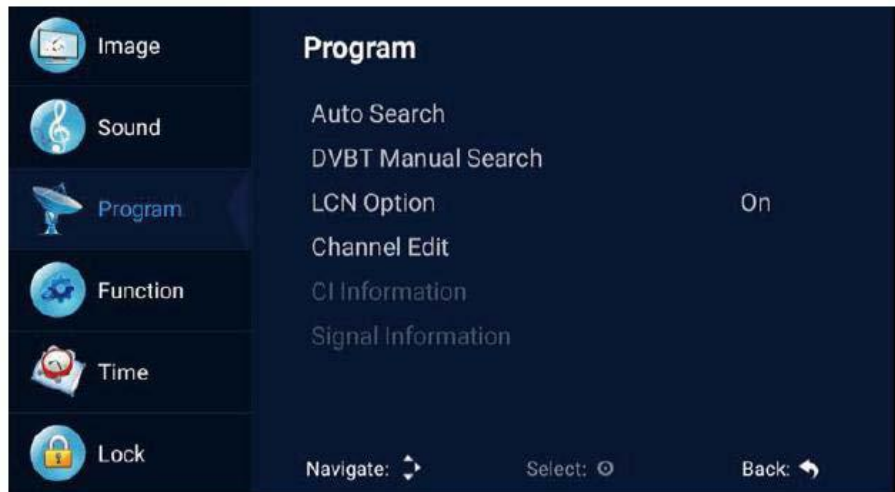

## DVB-T automatska pretraga



Izaberite opciju „Auto Tuning“ pomoću strelica nagore i nadole. Zatim pritisnite dugme OK i automatska pretraga će početi.

## DTV ručna pretraga



Da biste simulirali ručnu pretragu, izaberite odgovarajući opseg za vašu zemlju; možete da izaberete i boje i format zvuka, pritiskanjem strelica izaberite opciju „Search“; možete i da pritisnete strelicu ulevo za pretragu, a dostupno je i fino podešavanje frekvencije kojim se bira ona optimalna.

## DTV-S automatska pretraga

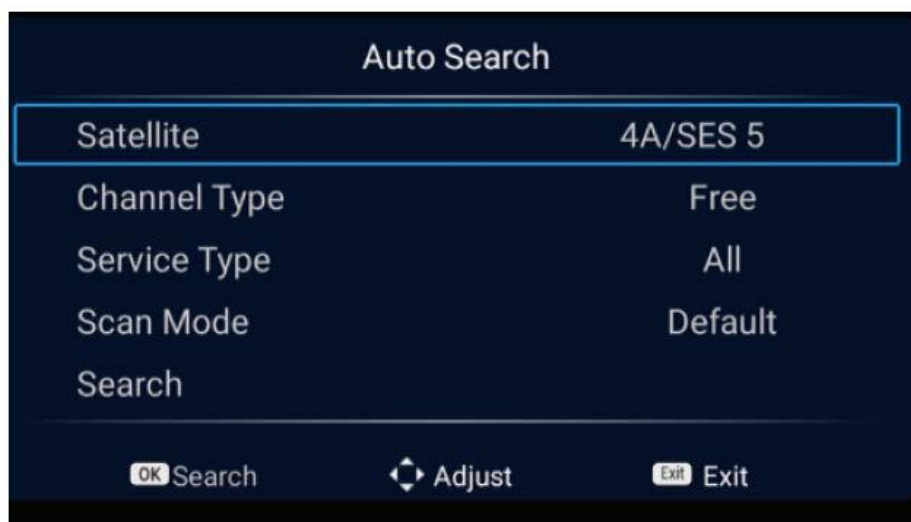



**Satelit**

Izaberite odgovarajući satelit u skladu sa lokalnim potrebama.

**Tip kanala**

Izaberite tip satelita.

**Tip usluge**

Izaberite tip usluge

**Režim skeniranja**

Izaberite režim skeniranja satelita.

**DTV-S ručna pretraga****Satelit**

Služi za biranje lokalnog satelita.

**Predajnik**

Opisuje izvor programa sa simbolom stope frekvencije i komponenti polarizacije.

## Funkcija

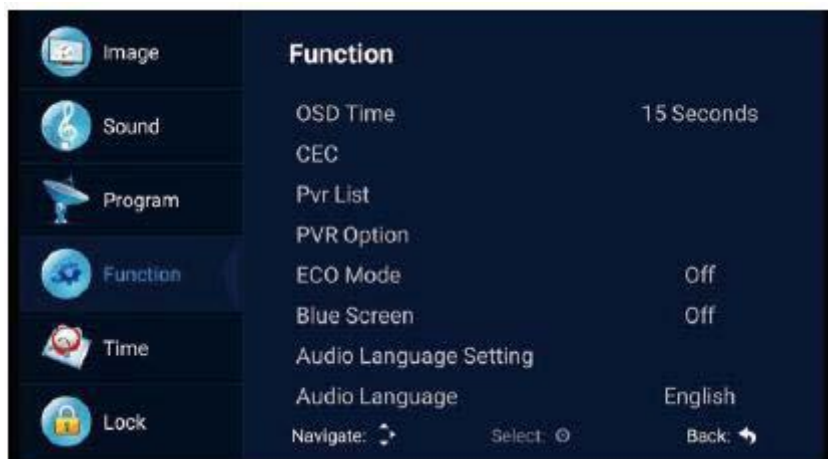

### OSD vreme

Pritisnite opciju za „menu display time“ i strelicama ulevo i udesno izaberite 5 sekundi, 10 sekundi, 15 sekundi, 20 sekundi, 30 sekundi ili uvek opciono

### CEC

Pritiskanjem strelica nagore i nadole izaberite ovu opciju, pa otvorite funkciju CEC strelicama ulevo i udesno. Kada se otvori CEC, možete da uključite ili isključite Auto režim pripravnosti, Automatsko uključivanje, ARC, Lista uređaja, Isključivanje TV-a, CEC uređaji će se takođe automatski isključiti.

### Resetuj

Izaberite opciju za „restore default settings“ pomoću strelica nagore i nadole, pa pritisnite OK da biste otvorili sledeći prozor. Možete da potvrdite ili otkazete; ako potvrdite TV će se isključiti pa uključiti, a ako otkazete vratićete se u interfejs menija.

## Vreme

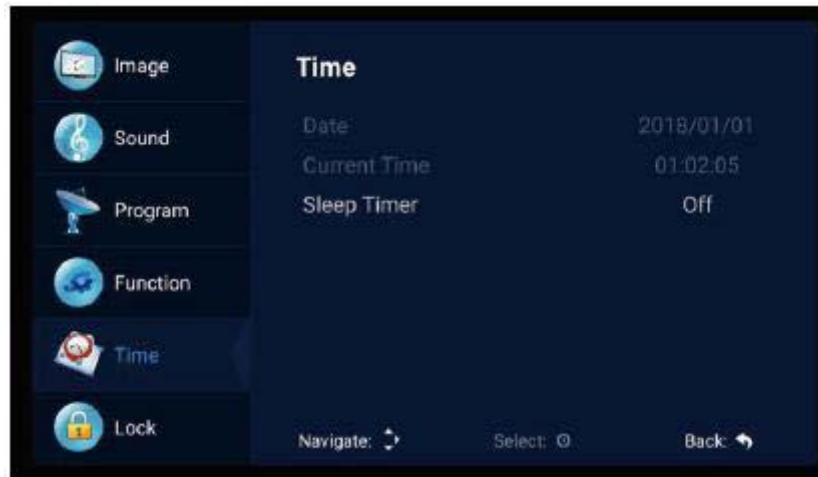

### Datum i trenutno vreme

Ovo se ne može podešavati, jer se automatski kalibriše na osnovu signala.

### Vreme do isključivanja

Sistem nudi više opcija vremena do isključivanja.

### Zaključaj

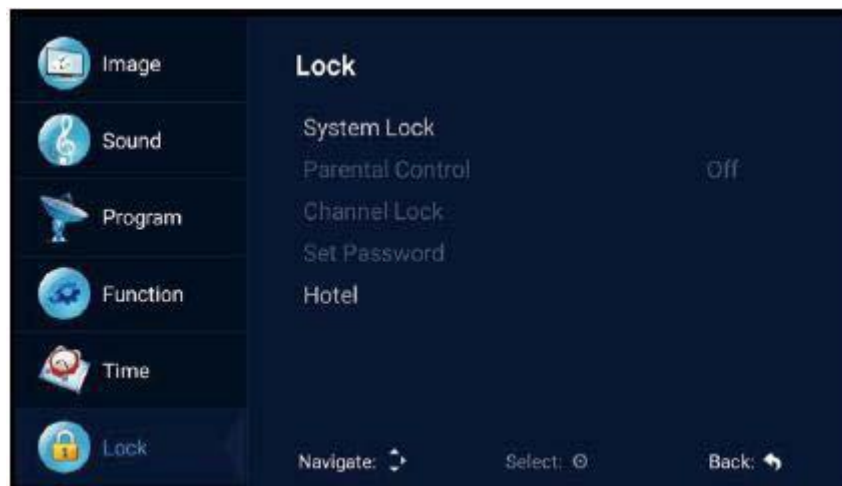

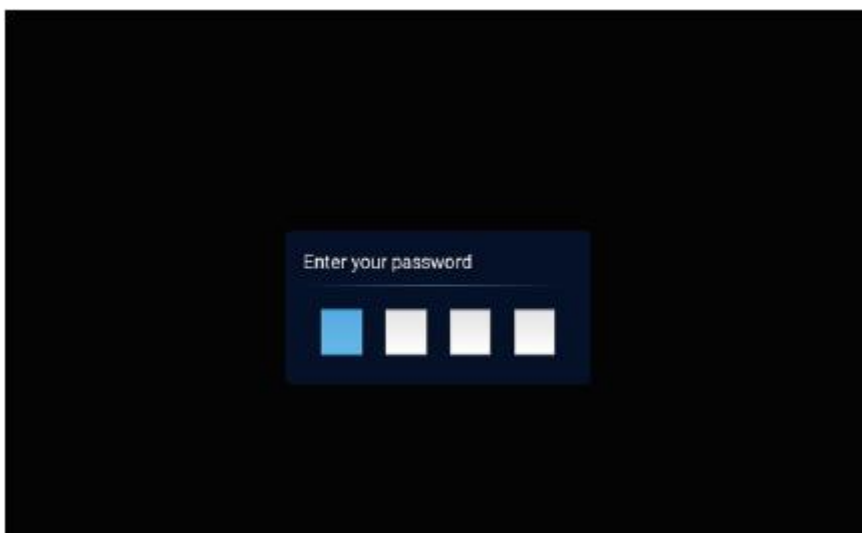

Pritiskanjem strelica nagore i nadole možete da izaberete opciju „Lock System“. Funkciju zaključavanja otvarate tasterima ulevo i udesno. Upamtite da je inicijalna lozinka 0000. Ako želite da podesite lozinku, prvo treba da izaberete opciju za podešavanje lozinke i da unesete staru lozinku, novu lozinku, čime ste uspešno resetovali lozinku. Kada želite da blokirate neke programe koje ne volite, izaberite opciju blokiranja programa i unesite broj kanala.

### Hotelski režim

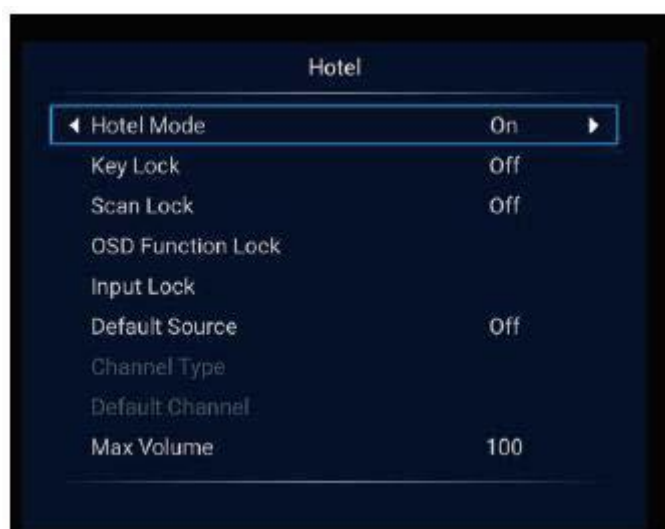

U ovom režimu možete da upravljate otvaranjem i zatvaranjem relevantnih kanala, podešavanjem jezika i menjanjem odnosa stranica slike

#### **Zaključavanje tastature**

Pritiskanjem opcije „Key Lock“ uključujete i isključujete taj meni pomoću strelica ulevo i udesno.

#### **Zaključavanje skeniranja**

Pritiskanjem opcije „Scan Lock“ uključujete i isključujete taj meni pomoću strelica ulevo i udesno.

#### **Zaključavanje unosa**

Pritiskanjem opcije „Input Lock“ uključujete i isključujete taj meni pomoću strelica ulevo, udesno, nagore i nadole.

#### **Podrazumevani izvor**

Pritisnite opciju „Default Source“ da biste uključili ili isključili meni preko tastera sa strelicama nalevo i nadesno.

#### **Maksimalna jačina zvuka**

Pritisnite da biste izabrali opciju „max volume“ i podesili parametre preko tastera sa strelicama nalevo i nadesno.

#### **Podrazumevana jačina zvuka**

Pritisnite da biste izabrali opciju „default volume“ i podesili parametre preko tastera sa strelicama nalevo i nadesno.

#### **Ulaz**

Ubacite USB čvrsti disk, na njemu se nalaze odgovarajuće datoteke, kliknite na „Uvoz podataka“.

#### **Izlaz**

Ubacite USB čvrsti disk, kliknite na opciju „izvezi hotelske podatke na USB čvrsti disk“.

#### **Jezik**

Pritisnite opciju „language“ da biste uključili izbor jezika pomoću tastera sa strelicama nagore i nadole.

#### **Razmera**

Pritisnite opciju „Aspect Ratio“ da biste podesili parametre preko tastera sa strelicama nalevo i nadesno.

#### **Obnovi**

Pritisnite opciju „Restore“ da biste resetovali podešavanja iznad.

### 3. Mediji



#### **Slike**

Koristite tastere sa strelicama nagore i nadole da biste izabrali ikonu „picture“, pritisnite taster za potvrdu da biste potvrdili, a zatim pritisnite udesno prema fascikli, pritisnite taster za potvrdu da biste otvorili odgovarajuću fasciklu. Nakon izbora slike, pritisnite taster za potvrdu da biste otvorili sliku. Možete obaviti još neke operacije pomoću tastera sa strelicama ulevo i udesno.

#### **Muzika**

Koristite tastere sa strelicama nagore i nadole da biste izabrali ikonu „pesme“, pritisnite taster za potvrdu da biste potvrdili, a zatim pritisnite udesno prema fascikli, pritisnite taster za potvrdu da biste otvorili odgovarajuću fasciklu. Nakon izbora pesme, pritisnite taster za potvrdu da biste otvorili pesmu. Možete obaviti još neke operacije pomoću tastera sa strelicama ulevo i udesno.

#### **Video**

Koristite tastere sa strelicama nagore i nadole da biste izabrali ikonu „video“, pritisnite taster za potvrdu da biste potvrdili, a zatim pritisnite udesno prema fascikli, pritisnite taster za potvrdu da biste otvorili odgovarajuću fasciklu. Nakon izbora videa, pritisnite taster za potvrdu da biste otvorili video. Možete obaviti još neke operacije pomoću tastera sa strelicama ulevo i udesno.

## 4. Android

### Početna



Glavna stranica koristi Zeasn UI dizajn i podijeljena je na: ŠTA IMA NOVO, APLIKACIJE, MUZIKA, Sport  
\*Različiti regioni će dobiti različit sadržaj.

### Podešavanja



Izaberite sliku podešavanja i pritisnite dugme OK da bi se prikazao interfejs android podešavanja.  
Sledi kratak opis funkcije svakog od menija.

## Mreža

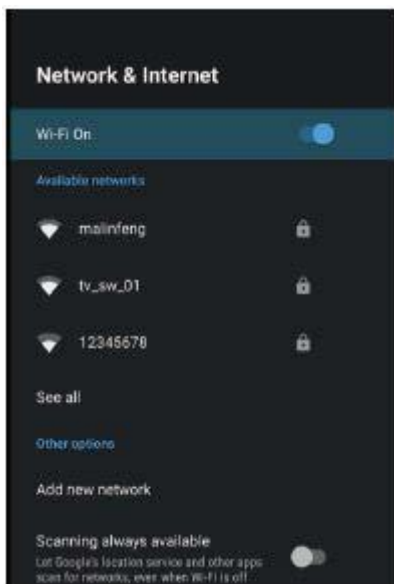

Uđite u stavku „Wi-Fi“ iz menija „Network“. Možete da otvorite ili zatvorite funkciju Wi-Fi veze. Postoji 4 tipa veze: izaberite željenu vezu i unesite lozinku, koristite vezu koja nije zaštićena lozinkom, ručno dodajte naziv pristupne tačke za povezivanje, i koristite „point-to-point“ direktnu vezu.

## Zvuk

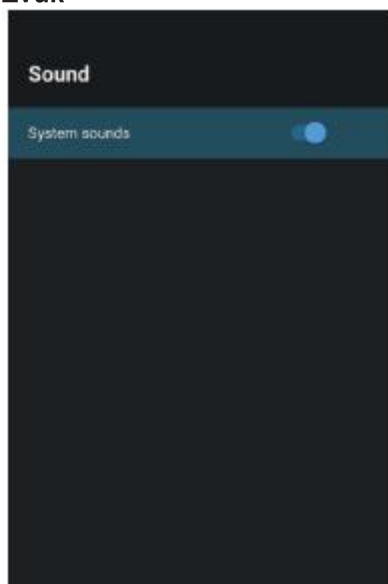

Podesi zvuk tastera



## Aplikacije

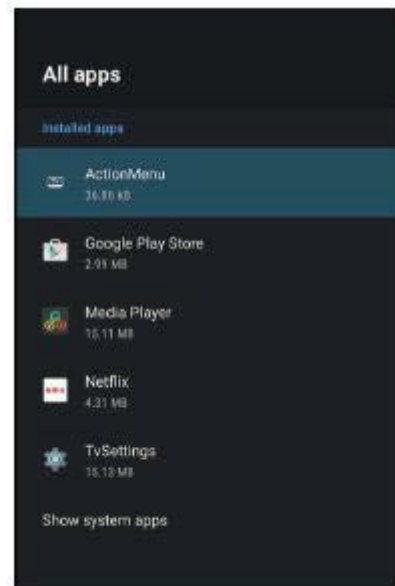
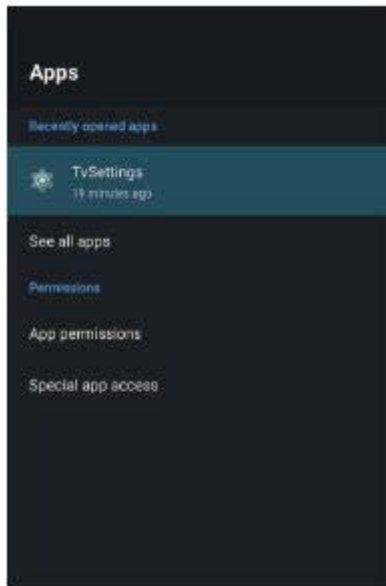

U meniju možete da vidite instalirane aplikacije, aplikacije koje su pokrenute kao i sve aplikacije.

## Resetuj

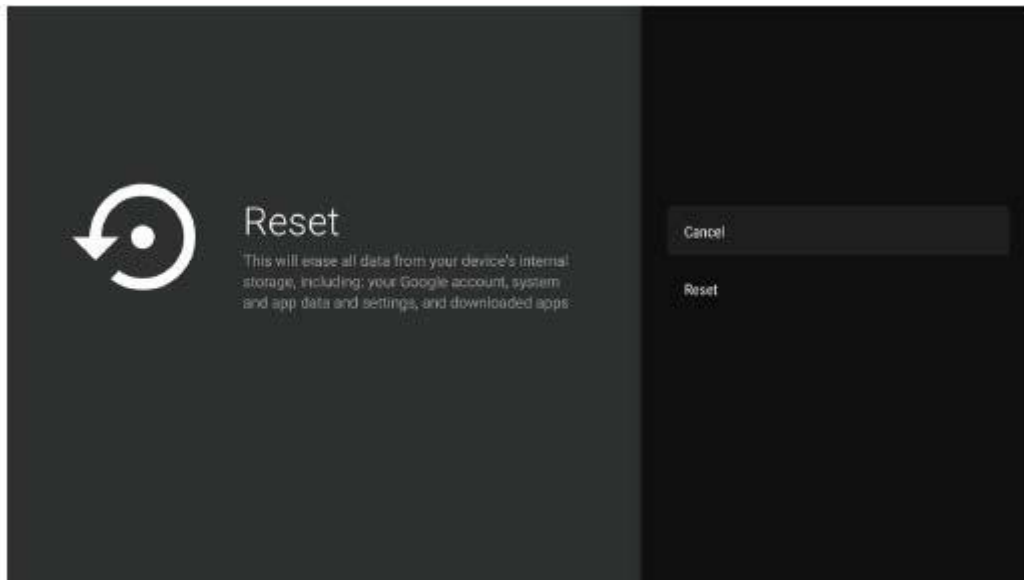

Ovde možete da prikazete pojedinosti o internom prostoru za skladištenje i korišćenju SD kartice, a postoji i opcija za pravljenje rezervne kopije i resetovanje. Možete izvršiti resetovanje na fabričke podatke. Nakon resetovanja. Za ažuriranje sistema).

## Informacije o

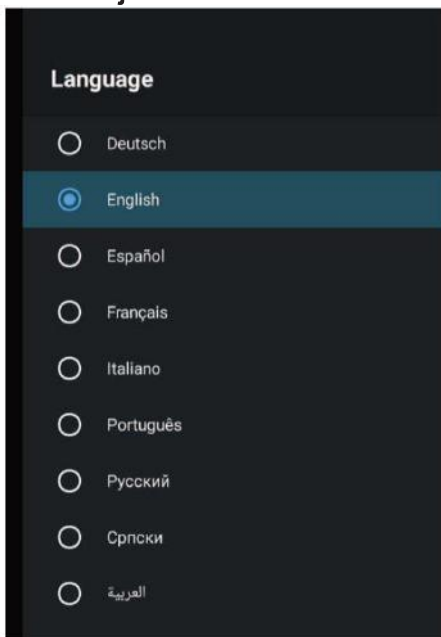

Možete da prikazete i podesite relevantne podatke za bežičnu nadogradnju, takođe možete da prikazete informacije o modelu, Android verziji i broju verzije.

## Datum i vreme

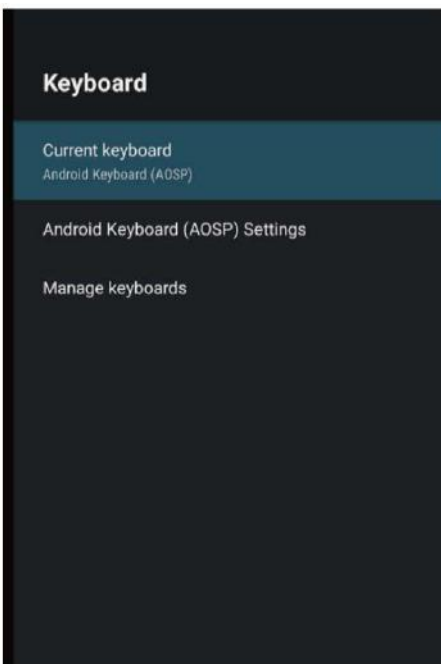

U ovom delu, možete da promenite datum i vreme i da izaberete sinhronizaciju sa datumom i vremenom mreže.

## Jezik



Ovde možete da izaberete jezik sistema.

## Tastatura

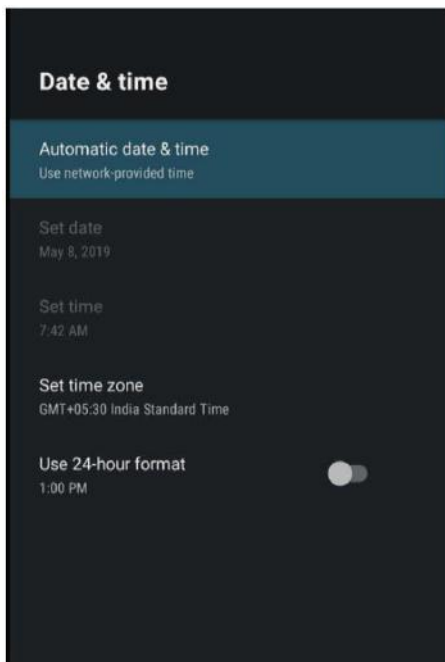

Korisnici mogu da se baziraju na ličnom izboru podešavanja unosa tastature. Takođe možete da prikazete lični rečnik.

## POMOĆ

Nema napajanja	<ul style="list-style-type: none"> <li>• Proverite da li je naponski kabl za televizor priključen ili ne. Ako i dalje nema napajanja, isključite kabl iz utičnice i ponovo ga uključite u utičnicu nakon 60 sekundi. Ponovo uključite napajanje.</li> </ul>
Loš prijem signala	<ul style="list-style-type: none"> <li>• Na televizoru možete videti duple ili fantomske slike ako ste u blizini visokih zgrada ili planina. Sliku možete da prilagodite ručno: pogledajte uputstvo za preciznu regulaciju ili podesite smer spoljne antene.</li> <li>• Ako koristite sobnu antenu, pod određenim okolnostima može doći do otežanog prijema signala. Podesite smer antene za optimalni prijem. Ako to ne poboljša prijem možda ćete morati da koristite spoljnu antenu.</li> </ul>
Nema slike	<ul style="list-style-type: none"> <li>• Proverite da li je antena pravilno povezana sa zadnje strane televizora.</li> <li>• Pogledajte druge kanale da biste proverili da li se problem javlja i na njima.</li> </ul>
Video je bez zvuka	<ul style="list-style-type: none"> <li>• Pokušajte da povećate glasnoću.</li> <li>• Proverite da li je zvuk na televizoru privremeno isključen ili ne.</li> </ul>
Zvuk je prisutan, ali nema videa ili je video bez boja	<ul style="list-style-type: none"> <li>• Pokušajte da podesite kontrast i osvetljenost.</li> </ul>
Statički šum utiče na kvalitet videa i zvuka	<ul style="list-style-type: none"> <li>• Proverite da li je antena pravilno povezana sa zadnje strane televizora.</li> </ul>
Isprekidane linije na ekranu	<ul style="list-style-type: none"> <li>• Električni uređaji poput fenova i usisivača mogu da izazovu smetnje na televizoru. Isključite ove uređaje.</li> </ul>
Daljinski upravljač nije u funkciji	<ul style="list-style-type: none"> <li>• Proverite da li ste skinuli plastičnu kesu sa kojom je dostavljen daljinski upravljač. Pokušajte da koristite daljinski upravljač bliže televizoru. Proverite da li su baterije pravilno postavljene ili pokušajte da postavite nove baterije u daljinski upravljač.</li> <li>• Televizor će preći u režim pripravnosti ako ubrzo ne dobije odziv.</li> </ul>
Nema videa (režim za računar)	<ul style="list-style-type: none"> <li>• Proverite da li je kabl pravilno priključen na VGA priključak i da li je kabl negde presavijen.</li> </ul>
Vertikalna linija koja treperi (režim za računar)	<ul style="list-style-type: none"> <li>• Uđite u glavni meni i podesite vertikalni položaj kako biste uklonili vertikalnu liniju.</li> </ul>
Horizontalno cepanje (režim za računar)	<ul style="list-style-type: none"> <li>• Podesite horizontalni položaj ekrana da biste obrisali sve horizontalne linije.</li> </ul>
Ekran je suviše taman ili svetao (režim za računar)	<ul style="list-style-type: none"> <li>• Podesite osvetljenost ili kontrast u glavnom meniju.</li> </ul>
Nema odziva od računara	<ul style="list-style-type: none"> <li>• Proverite da li je rezolucija za prikaz na računaru podešena na rezoluciju koja je kompatibilna sa televizorom.</li> </ul>
Pojava linija kada se uređaj poveže na RCA priključak	<ul style="list-style-type: none"> <li>• Proverite da li koristite kvalitetan kabl.</li> </ul>
Problemi nisu rešeni	<ul style="list-style-type: none"> <li>• Isključite kabl za napajanje i sačekajte 30 sekundi a onda ponovo uključite kabl u utičnicu. Ako i dalje postoji problem, nemojte sami da pokušavate da popravite televizor. Kontaktirajte servisni centar.</li> </ul>

Ne ostavljajte statičnu sliku na televizoru u dužem vremenskom periodu, bilo da potiče od videa koji je pauziran, ekrana menija, itd. To će oštetiti displej i može dovesti do utiskivanja slike.

## SPECIFIKACIJE

<b>Razmera</b>	16 : 9
<b>Sistem</b>	PAL/SECAM BG/DK/I, DVB-T/T2+C, NTSC reprodukcija
<b>Osnovna impedansa</b>	75Ω (nesimetrično)
<b>Prijemni TV opseg</b>	Svi kanali čiji je prijem moguć
<b>Napon naizmeničnog napajanja</b>	100-240V-50/60HZ

**Napomena:** Deo dizajna i specifikacija se može promeniti bez prethodne najave.

### INFRACRVENI DALJINSKI UPRAVLJAČ

**Karakteristike:** Daljinski upravljač sa svim funkcijama

**Najveći efektivni domet:** 8 metara

**Napajanje:** Jednosmerna struja 3V (dve baterije veličine AAA, preporučujemo alkalne baterije)



Proizvedeno pod licencom Dolby Laboratories.  
Dolby, Dolby Audio, Pro logic, i simbol „double-D“  
su zaštitni znaci Dolby Laboratories.

	Radna frekvencija	Snaga emitovanja
Wi-Fi	2412-2472 MHz	Manje od 100 mW

**NAPOMENA:**

FUNKCIJA BEŽIČNOG PRIKAZA NE PODRŽAVA SVE MOBILNE UREĐAJE.

PROVERITE DA LI OVA FUNKCIJA PODRŽAVA VAŠ MOBILNI UREĐAJ.

## DALJINSKI UPRAVLJAČ

Daljinski upravljač ne možete da koristite van dometa za prijem. Pre upotrebe daljinskog upravljača proverite ima li prepreka između daljinskog upravljača i prijemnika.

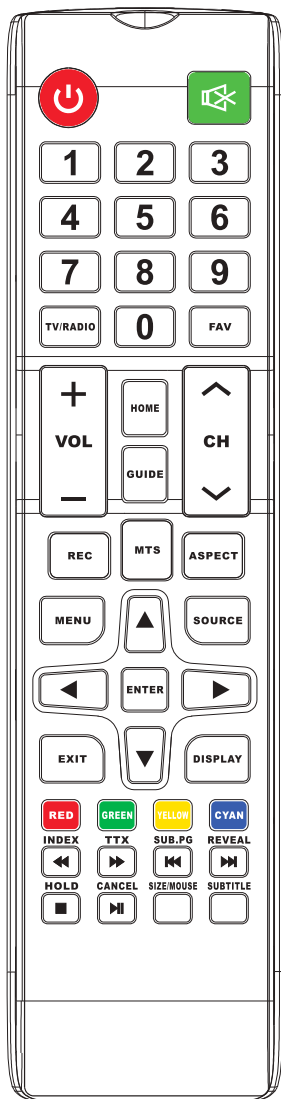

1. **NAPAJANJE:** Uključite televizor ili uđite u režim pripravnosti.
2. **PRIGUŠI ZVUK:** Isključite zvuk i ponovo ga uključite kada opet pritisnete dugme.
3. **0-9:** Brojevi od 0 do 9 se koriste za direktan unos broja kanala.
4. **MTS:** Pritisnite za izbor MTS režima. (na primer, Nicam, BTSC MONO STEREO itd.)
5. **MENU:** Pokrenite sistemski meni i vratite se na prethodni meni.
6. **SOURCE:** Taster za izbor ulaznog izvora.
7. **▲▼◀▶** Pritisnite taster ▲▼ za izbor stavki. Pritisnite taster ◀▶ za njihovo podešavanje.
8. **ENTER:** Za potvrdu izbora označene stavke menija.
9. **EXIT:** Pritisnite za izlaz iz OSD menija.
10. **DISPLAY:** Pritisnite za prikaz izvora i kanala.
11. **VOL+:** Povećavanje glasnoće.
12. **HOLD:** Uključite ili isključite zadržavanje trenutne stranice koja je prikazana.
13. **VOL-:** Smanjivanje glasnoće.
14. **PLAY/PAUSE:** Pritisnite za REPRODUKCIJU/PAUZU u USB režimu, započni reprodukciju i PAUZIRAJ u USB režimu.
15. **CANCEL:** Prilikom izbora stranice u režimu teleteksta, traženje stranice može da potraje. Pritiskom na taster CANCEL vraćate se u režim televizije. Kada se željena stranica pronađe, broj stranice će se prikazati na vrhu televizijske slike. Pritisnite CANCEL za povratak u režim teleteksta kako biste pregledali tu stranicu.
16. **TV/RADIO:** Omogućava vam prebacivanje između TV i Radio režima prilikom praćenja kanala.
17. **STOP:** Pritisnite za zaustavljanje u USB režimu.
18. **CH+:** Idi na sledeći broj programa.
19. **HOME:** Taster za povratak na android matičnu stranicu.
20. **CH-:** Vrti se na prethodni broj programa.
21. **ASPECT:** Funkcija razmere.
22. **MOUSE:** Prekidač za miša.
23. **SIZE:** Promenite veličinu displeja u režimu teleteksta.
24. **SUBTITLE:** Za prikaz titlova u USB režimu.
25. **REC:** Početak snimanja u PVR režimu.
26. **GUIDE:** Pokreće EPG (elektronski programski vodič)
27. **FAV:** Pritisnite da biste dodali ili uklonili svoje omiljene kanale u tv meniju.
28. **FF:** Pritisnite za brzo premotavanje unapred u USB režimu.
29. **PREV:** Pritisnite za povratak na prethodno u USB režimu
30. **SUB. PG:** Pritisnite za pristup podstranici.
31. **FR:** Pritisnite za brzo premotavanje unazad u USB režimu.
32. **INDEX:** Zatražite Indeksnu stranicu u teletekst režimu.
33. **NEXT:** Pritisnite za prelazak na sledeće u USB režimu.
34. **REVEAL:** Otkrij ili sakrij skrivene reči.

## ZAŠTITA ŽIVOTNE SREDINE



### **Pažnja!**

Proizvod je označen sledećim simbolom. On ukazuje da na kraju životnog veka ne treba da ga odložite zajedno sa ostalim otpadom iz domaćinstva. Sva iskorišćena elektronska ili električna oprema treba da se razdvoji od običnog otpada i reciklira na odgovoran način, na osnovu zakona o odgovornom odlaganju otpada.

U skladu sa sprovođenjem EU odredbi o odlaganju otpada, korisnici u domaćinstvu mogu besplatno da vrate svu korišćenu elektronsku i električnu opremu na naznačenim punktovima za prikupljanje elektronskog otpada. Prilikom kupovine novog proizvoda obratite se svojoj lokalnoj vladinoj kancelariji za više informacija.

Ako proizvod ima baterije, uklonite ih u skladu sa zakonom.

Pravilno odlaganje električnog i elektronskog otpada promovise održivo ponovno

korišćenje materijalnih resursa i recikliranje. Na ovaj način sprečavate moguće štetne posledice po životnu sredinu i ljudsko zdravlje.

Nekontrolisano odlaganje električnog i elektronskog otpada može da naškodi životnoj sredini.

### **Informacije za poslovne korisnike u zemljama Evropske unije**

Ako je proizvod koji odlažete korišćen u poslovne svrhe, obratite se svom prodavcu kako biste dobili podatke o načinu prikupljanja, odlaganja i recikliranja kao i o mogućim troškovima. Ako želite da odložite mali uređaj, možete da ga vratite na lokalni punkt za prikupljanje elektronskog otpada.

### **Informacije za poslovne korisnike u zemljama van Evropske unije**

Ako želite da odložite korišćeni proizvod, obratite se lokalnoj vladinoj kancelariji kako biste dobili podatke o odgovarajućem obliku recikliranja.



Nadamo se da ste pažljivo pročitali uputstva i da ćete ih se pridržavati.  
Za više informacija o FOX uređajima posetite našu internet stranicu:

**[www.foxelectronics.rs](http://www.foxelectronics.rs)**